



GE Fanuc Automation

Computer Numerical Control Products

Series 16i / 160i / 160is—Model A
Series 18i / 180i / 180is—Model A

Parameter Manual

GFZ-63010EN/02

February 2001

Warnings, Cautions, and Notes as Used in this Publication

Warning

Warning notices are used in this publication to emphasize that hazardous voltages, currents, temperatures, or other conditions that could cause personal injury exist in this equipment or may be associated with its use.

In situations where inattention could cause either personal injury or damage to equipment, a Warning notice is used.

Caution

Caution notices are used where equipment might be damaged if care is not taken.

Note

Notes merely call attention to information that is especially significant to understanding and operating the equipment.

This document is based on information available at the time of its publication. While efforts have been made to be accurate, the information contained herein does not purport to cover all details or variations in hardware or software, nor to provide for every possible contingency in connection with installation, operation, or maintenance. Features may be described herein which are not present in all hardware and software systems. GE Fanuc Automation assumes no obligation of notice to holders of this document with respect to changes subsequently made.

GE Fanuc Automation makes no representation or warranty, expressed, implied, or statutory with respect to, and assumes no responsibility for the accuracy, completeness, sufficiency, or usefulness of the information contained herein. No warranties of merchantability or fitness for purpose shall apply.

Export Control Information

This document and the information contained in this document are classified with an Export Control Classification Number of 2E201. It is restricted and controlled under US export regulations. If you intend to export (or reexport), the document, directly or indirectly, or technical information relating thereto supplied hereunder or any portion thereof, it is your responsibility to ensure compliance with U.S. export control regulations and, if appropriate, to secure any required export licenses in your own name.

PREFACE

The mode covered by this manual, and their abbreviations are :

Product Name	Abbreviations	
FANUC Series 16i-TA	16i-TA	Series 16i
FANUC Series 16i-MA	16i-MA	
FANUC Series 160i-TA	160i-TA	Series 160i
FANUC Series 160i-MA	160i-MA	
FANUC Series 160is-TA	160is-TA	Series 160is
FANUC Series 160is-MA	160is-MA	
FANUC Series 18i-TA	18i-TA	Series 18i
FANUC Series 18i-MA	18i-MA	
FANUC Series 180i-TA	180i-TA	Series 180i
FANUC Series 180i-MA	180i-MA	
FANUC Series 180is-TA	180is-TA	Series 180is
FANUC Series 180is-MA	180is-MA	

NOTE

1 For ease of explanation, the models may be classified as follows:

T series: 16i-TA/160i-TA/160is-TA/18i-TA/180i-TA/180is-TA

M series: 16i-MA/160i-MA/160is-MA/18i-MA/180i-MA/180is-MA

2 Some functions described in this manual may not be applied to some products.

For details, refer to the DESCRIPTIONS (B-63002EN).

The table below lists manuals related to MODEL A of Series 16*i*, Series 18*i*, Series 160*i*, Series 180*i*. In the table, this manual is marked with an asterisk (*).

Table 1 Related manuals

Manual name	Specification Number	
DESCRIPTIONS	B-63002EN	
CONNECTION MANUAL (HARDWARE)	B-63003EN	
CONNECTION MANUAL (FUNCTION)	B-63003EN-1	
OPERATOR'S MANUAL (For Lathe)	B-63004EN	
OPERATOR'S MANUAL (For Machining Center)	B-63014EN	
MAINTENANCE MANUAL	B-63005EN	
PARAMETER MANUAL	B-63010EN	*
Related to Programming		
Macro Compiler/Macro Executor PROGRAMMING MANUAL	B-61803E-1	
C Language Executor PROGRAMMING MANUAL	B-62443EN-3	
FAPT MACRO COMPILER (For Personal Computer) PROGRAMMING MANUAL	B-66102E	
Manual for CAP (For Lathe)		
FANUC Super CAP T/Super CAP II T OPERATOR'S MANUAL	B-62444E-1	
Conversational Automatic Programming Function For Lathe II OPERATOR'S MANUAL	B-61804E-2	
FANUC Super CAP <i>i</i> T OPERATOR'S MANUAL	B-63284EN	
FANUC Symbol CAP <i>i</i> T OPERATOR'S MANUAL	B-63304EN	
MANUAL GUIDE PROGRAMMING MANUAL	B-63343EN	
MANUAL GUIDE OPERATOR'S MANUAL	B-63343EN	
Manual for CAP (For Machining Center)		
FANUC Super CAP <i>i</i> M OPERATOR'S MANUAL	B-63294EN	
MANUAL GUIDE (For Milling) PROGRAMMING MANUAL	B-63423EN	
MANUAL GUIDE (For Milling) OPERATOR'S MANUAL	B-63424EN	
PMC		
PMC Ladder language PROGRAMMING MANUAL	B-61863E	
PMC C language PROGRAMMING MANUAL	B-61863E-1	
Loader control		
Loader Control CONNECTION MANUAL	B-62443EN-2	
Related to Board		
PROFIBUS-DP Board OPERATOR'S MANUAL	B-62924EN	
Ethernet/DATA SERVER Board OPERATOR'S MANUAL	B-63354EN	
DeviceNet Board OPERATOR'S MANUAL	B-63404EN	
FL-net Board OPERATOR'S MANUAL	B-63434EN	

Table of Contents

PREFACE	p-1
1. DISPLAYING PARAMETERS	1
2. SETTING PARAMETERS FROM MDI	2
3. INPUTTING AND OUTPUTTING PARAMETERS THROUGH THE READER/PUNCHER INTERFACE	4
3.1 OUTPUTTING PARAMETERS THROUGH THE READER/PUNCHER INTERFACE	5
3.2 INPUTTING PARAMETERS THROUGH THE READER/PUNCHER INTERFACE	6
4. DESCRIPTION OF PARAMETERS	7
4.1 PARAMETERS OF SETTING	9
4.2 PARAMETERS OF READER/PUNCHER INTERFACE, REMOTE BUFFER, DNC1, DNC2, AND M-NET INTERFACE	13
4.2.1 Parameters Common to all Channels	14
4.2.2 Parameters of Channel 1 (I/O CHANNEL=0)	15
4.2.3 Parameters of Channel 1 (I/O CHANNEL=1)	16
4.2.4 Parameters of Channel 2 (I/O CHANNEL=2)	17
4.2.5 Parameters of Channel 3 (I/O CHANNEL=3)	17
4.3 PARAMETERS OF DNC1/DNC2 INTERFACE	20
4.4 PARAMETERS OF M-NET INTERFACE	23
4.5 PARAMETERS OF REMOTE DIAGNOSIS	26
4.6 PARAMETERS OF DNC1 INTERFACE	30
4.7 PARAMETER OF MEMORY CARD INTERFACE	32
4.8 PARAMETERS OF FACTOLINK	33
4.9 PARAMETERS OF DATA SERVER	35
4.10 PARAMETERS OF ETHERNET	37
4.11 PARAMETERS OF POWER MATE CNC MANAGER	38
4.12 PARAMETERS OF AXIS CONTROL/INCREMENT SYSTEM	39
4.13 PARAMETERS OF COORDINATES	48
4.14 PARAMETERS OF STROKE CHECK	55
4.15 PARAMETERS OF THE CHUCK AND TAILSTOCK BARRIER (T SERIES)	60
4.16 PARAMETERS OF FEEDRATE	64
4.17 PARAMETERS OF ACCELERATION/DECELERATION CONTROL	77
4.18 PARAMETERS OF SERVO	96
4.19 PARAMETERS OF DI/DO	129
4.20 PARAMETERS OF MDI, DISPLAY, AND EDIT	133
4.21 PARAMETERS OF PROGRAMS	167
4.22 PARAMETERS OF PITCH ERROR COMPENSATION	178
4.23 PARAMETERS OF SPINDLE CONTROL	190
4.24 PARAMETERS OF TOOL COMPENSATION	239
4.25 PARAMETERS OF GRINDING-WHEEL WEAR COMPENSATION	254
4.26 PARAMETERS OF CANNED CYCLES	255
4.26.1 Parameter of canned Cycle for Drilling	255
4.26.2 Parameter of Thread Cutting Cycle	261

4.26.3	Parameter of Multiple Repetitive Canned Cycle	261
4.26.4	Parameters of Peck Drilling Cycle of a Small Diameter	263
4.27	PARAMETERS OF RIGID TAPPING	267
4.28	PARAMETERS OF SCALING/COORDINATE ROTATION	291
4.29	PARAMETERS OF UNI-DIRECTIONAL POSITIONING	293
4.30	PARAMETERS OF POLAR COORDINATE INTERPOLATION	294
4.31	PARAMETERS OF NORMAL DIRECTION CONTROL	297
4.32	PARAMETERS OF INDEXING INDEX TABLE	300
4.33	PARAMETERS OF INVOLUTE INTERPOLATION	302
4.34	PARAMETERS OF EXPONENTIAL INTERPOLATION	305
4.35	PARAMETERS OF FLEXIBLE SYNCHRONIZATION	306
4.36	PARAMETERS OF STRAIGHTNESS COMPENSATION	309
4.37	PARAMETERS OF GRADIENT COMPENSATION	311
4.38	PARAMETERS OF CUSTOM MACROS	312
4.39	PARAMETERS OF SIMPLE MACROS	320
4.40	PARAMETERS OF PATTERN DATA INPUT	321
4.41	PARAMETERS OF POSITIONING BY OPTIMUM ACCELERATION	322
4.42	PARAMETERS OF SKIP FUNCTION	326
4.43	PARAMETERS OF AUTOMATIC TOOL COMPENSATION (T SERIES) AND AUTOMATIC TOOL LENGTH COMPENSATION (M SERIES)	332
4.44	PARAMETERS OF EXTERNAL DATA INPUT/OUTPUT	334
4.45	PARAMETERS OF FINE TORQUE SENSING	335
4.46	PARAMETERS OF RETRACING BY THE MANUAL HANDLE	336
4.47	PARAMETERS OF GRAPHIC DISPLAY	345
4.47.1	Parameters of Graphic Display/Dynamic Graphic Display	345
4.47.2	Parameters of Graphic Color	349
4.48	PARAMETERS OF DISPLAYING OPERATION TIME AND NUMBER OF PARTS	351
4.49	PARAMETERS OF TOOL LIFE MANAGEMENT	355
4.50	PARAMETERS OF POSITION SWITCH FUNCTIONS	361
4.51	PARAMETERS OF MANUAL OPERATION AND AUTOMATIC OPERATION	364
4.52	PARAMETERS OF MANUAL HANDLE FEED, HANDLE INTERRUPTION AND HANDLE FEED IN TOOL AXIAL DIRECTION	369
4.53	PARAMETERS OF MANUAL LINE AND ARC FUNCTIONS	374
4.54	PARAMETERS OF REFERENCE POSITION SETTING WITH MECHANICAL STOPPER	375
4.55	PARAMETERS OF SOFTWARE OPERATOR'S PANEL	377
4.56	PARAMETERS OF PROGRAM RESTART	381
4.57	PARAMETERS OF HIGH-SPEED MACHINING (HIGH-SPEED CYCLE MACHINING/HIGH-SPEED REMOTE BUFFER)	382
4.58	PARAMETERS OF ROTARY TABLE DYNAMIC FIXTURE OFFSET	388
4.59	PARAMETERS OF POLYGON TURNING	390
4.60	PARAMETERS OF THE EXTERNAL PULSE INPUT	395
4.61	PARAMETERS OF THE HOBBING MACHINE AND SIMPLE ELECTRIC GEAR BOX (EGB)	396
4.62	PARAMETERS OF ATTITUDE CONTROL	403
4.63	PARAMETERS OF AXIS CONTROL BY PMC	406
4.64	PARAMETERS OF TWO-PATH CONTROL	413

4.65	PARAMETERS OF CHECKING INTERFERENCE BETWEEN TOOL POSTS (TWO-PATH CONTROL)	414
4.66	PARAMETERS OF PATH AXIS REASSIGNMENT	417
4.67	PARAMETERS OF ANGULAR AXIS CONTROL	430
4.68	PARAMETERS OF B-AXIS CONTROL	432
4.69	PARAMETERS OF SIMPLE SYNCHRONOUS CONTROL	435
4.70	PARAMETERS OF CHECK TERMINATION	444
4.71	PARAMETERS OF CHOPPING	445
4.72	PARAMETERS OF HIGH-SPEED HIGH-PRECISION CONTOUR CONTROL BY RISC (M SERIES)	448
4.72.1	Parameters of Acceleration and Deceleration before Interpolation	448
4.72.2	Parameters of Automatic Speed Control	450
4.72.3	Parameters of Automatic Velocity Setting	451
4.72.4	Parameters of Axis Control	458
4.73	PARAMETERS OF HIGH-SPEED POSITION SWITCHES (1/2)	459
4.74	OTHER PARAMETERS	465
4.75	PARAMETERS OF MAINTENANCE	471
4.76	PARAMETERS OF BUILT-IN MACRO	472
4.77	PARAMETERS OF HIGH-SPEED POSITION SWITCHES (2/2)	476
4.78	PARAMETERS OF OPERATION HISTORY	478

APPENDIX

A. CHARACTER CODE LIST	485
-------------------------------------	------------

1 DISPLAYING PARAMETERS

Follow the procedure below to display parameters.

- (1) Press the **SYSTEM** function key on the MDI as many times as required, or alternatively, press the **SYSTEM** function key once, then the **PARAM** section display soft key. The parameter screen is then selected.

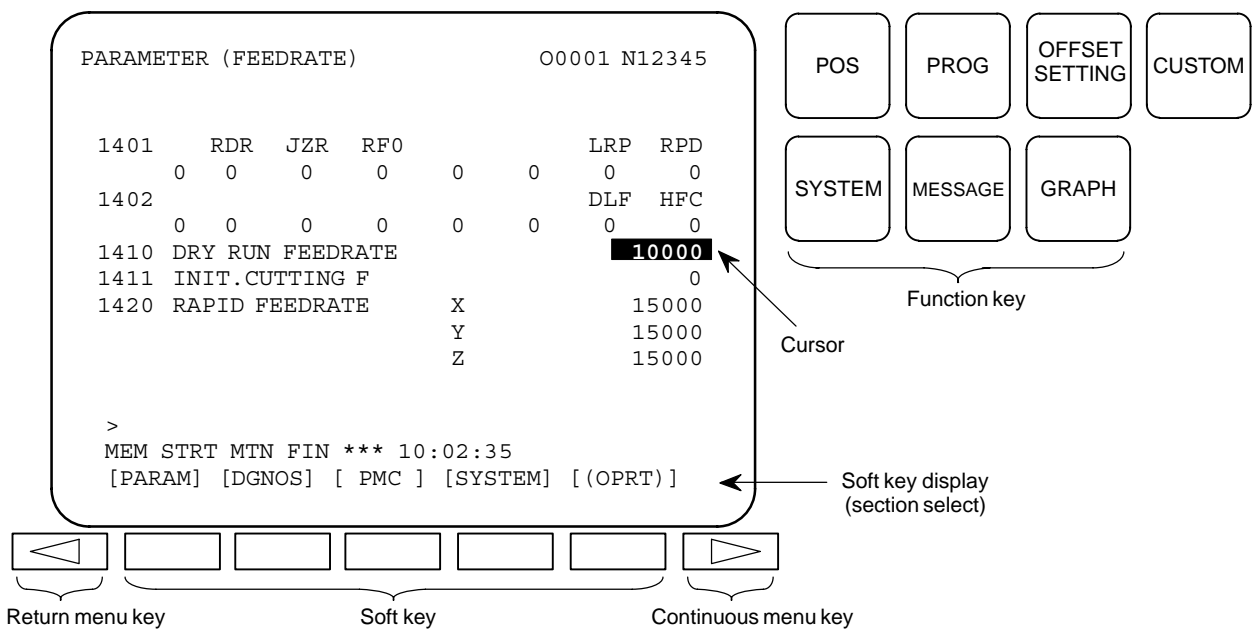

- (2) The parameter screen consists of multiple pages. Use step (a) or (b) to display the page that contains the parameter you want to display.
 - (a) Use the page select key or the cursor move keys to display the desired page.
 - (b) Enter the data number of the parameter you want to display from the keyboard, then press the **[NO.SRH]** soft key. The parameter page containing the specified data number appears with the cursor positioned at the data number. (The data is displayed in reverse video.)

NOTE
If key entry is started with the section select soft keys displayed, they are replaced automatically by operation select soft keys including **[NO.SRH]**. Pressing the **[(OPRT)]** soft key can also cause the operation select keys to be displayed.

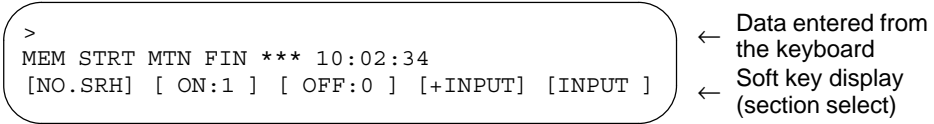

2 SETTING PARAMETERS FROM MDI

Follow the procedure below to set parameters.

- (1) Place the NC in the MDI mode or the emergency stop state.
- (2) Follow the substeps below to enable writing of parameters.
 1. To display the setting screen, press the **SETTING** function key as many times as required, or alternatively press the **SETTING** function key once, then the **SETTING** section select soft key. The first page of the setting screen appears.
 2. Position the cursor on “PARAMETER WRITE” using the cursor move keys.

```

SETTING (HANDY)                                00001 N00010
PARAMETER WRITE = 0 (0:DISABLE 1:ENABLE)
TV CHECK        = 0 (0:OFF      1:ON)
PUNCH CODE     = 0 (0:EIA      1:ISO)
INPUT UNIT     = 0 (0:MM       1:INCH)
I/O CHANNEL    = 0 (0-3:CHANNEL NO.)
  
```

3. Press the **[(OPRT)]** soft key to display operation select soft keys.

```

>
MDI STOP *** *** *** 10:03:02
[NO.SRH] [ ON:1 ] [ OFF:0 ] [+INPUT] [INPUT]
  
```

← Soft key display
(section select)

4. To set “PARAMETER WRITE=” to 1, press the ON:1 soft key, or alternatively enter 1 and press the INPUT soft key. From now on, the parameters can be set. At the same time an alarm condition (P/S100 PARAMETER WRITE ENABLE) occurs in the CNC.
- (3) To display the parameter screen, press the **SYSTEM** function key as many times as required, or alternatively press the **SYSTEM** function key once, then the **PARAM** section select soft key. (See “1. Displaying Parameters.”)
- (4) Display the page containing the parameter you want to set, and position the cursor on the parameter. (See “1. Displaying Parameters.”)
- (5) Enter data, then press the **[INPUT]** soft key. The parameter indicated by the cursor is set to the entered data.

[Example] 12000 [INPUT]

PARAMETER (FEEDRATE)		O0001 N00010	
1401	RDR	JZR	RPD
	0 0 0 0 0	0 0 0 0	
1402	JRV		
	0 0 0 0 0	0 0 0 0	
1410	DRY RUN FEEDRATE		12000
1412			0
1420	RAPID FEEDRATEX		15000
		Y	15000
		Z	15000
>			
MDI STOP *** *** ALM 10:03:10			
[NO.SRH] [ON:1] [OFF:0] [+INPUT] [INPUT]			

Cursor

Data can be entered continuously for parameters, starting at the selected parameter, by separating each data item with a semicolon (;).

[Example] Entering 10;20;30;40 and pressing the INPUT key assigns values 10, 20, 30, and 40 to parameters in order starting at the parameter indicated by the cursor.

- (6) Repeat steps (4) and (5) as required.
- (7) If parameter setting is complete, set "PARAMETER WRITE=" to 0 on the setting screen to disable further parameter setting.
- (8) Reset the NC to release the alarm condition (P/S100).
If an alarm condition (P/S000 PLEASE TURN OFF POWER) occurs in the NC, turn it off before continuing operation.

3

INPUTTING AND OUTPUTTING PARAMETERS THROUGH THE READER/PUNCHER INTERFACE

This section explains the parameter input/output procedures for input/output devices connected to the reader/puncher interface.

The following description assumes the input/output devices are ready for input/output. It also assumes parameters peculiar to the input/output devices, such as the baud rate and the number of stop bits, have been set in advance.

3.1 OUTPUTTING PARAMETERS THROUGH THE READER/PUNCHER INTERFACE

- (1) Select the EDIT mode or set to Emergency stop.
- (2) To select the parameter screen, press the SYSTEM function key as many times as required, or alternatively press the SYSTEM function key once, then the PARAM section select soft key.
- (3) Press the **[OPRT]** soft key to display operation select soft keys, then press the forward menu key located at the right-hand side of the soft keys to display another set of operation select keys including PUNCH.

```

PARAMETER (FEEDRATE)                O0001  N00010

1401      RDR                        JZR      RPD
        0  0  0  0  0  0  0  0  0
1402                        JRV
        0  0  0  0  0  0  0  0  0
1410  DRY RUN FEEDRATE                12000
1412
1420  RAPID FEEDRATEX                  15000
                                      Y      15000
                                      Z      15000

>
MDI STOP *** ** ALM 10:03:10
[NO.SRH] [ON:1] [OFF:0] [+INPUT] [INPUT]
    
```

Cursor

← State display
← Soft key display (operation select)

- (4) Pressing the **[PUNCH]** soft key changes the soft key display as shown below:

```

>
EDIT STOP *** ** ** 10:35:03
[      ] [      ] [      ] [CANCEL] [ EXEC ]
    
```

- (5) Press the **[EXEC]** soft key to start parameter output. When parameters are being output, "OUTPUT" blinks in the state display field on the lower part of the screen.

```

>
EDIT STOP *** ** ** 10:35:04  OUTPUT
[      ] [      ] [      ] [CANCEL] [ EXEC ]
    
```

← OUTPUT blinking

- (6) When parameter output terminates, "OUTPUT" stops blinking. Press the RESET key to interrupt parameter output.

3.2 INPUTTING PARAMETERS THROUGH THE READER/PUNCHER INTERFACE

- (1) Place the NC in the emergency stop state.
- (2) Enable parameter writing.
 1. To display the setting screen, press the SETTING function key as many times as required, or alternatively press the SETTING function key once, then the SETTING section select soft key. The first page of the setting screen appears.
 2. Position the cursor on “PARAMETER WRITE” using the cursor move keys.
 3. Press the **[(OPRT)]** soft key to display operation select soft keys.
 4. To set “PARAMETER WRITE=” to 1, press the ON:1 soft key, or alternatively enter 1, then press the **[INPUT]** soft key. From now on, parameters can be set. At the same time an alarm condition (P/S100 PARAMETER WRITE ENABLE) occurs in the NC.
- (3) To select the parameter screen, press the SYSTEM function key as many times as required, or alternatively press the SYSTEM key once, then **[PARAM]** soft key.
- (4) Press the **[(OPRT)]** soft key to display operation select keys, then press the forward menu key located at the right-hand side of the soft keys to display another set of operation select soft keys including **[READ]**.

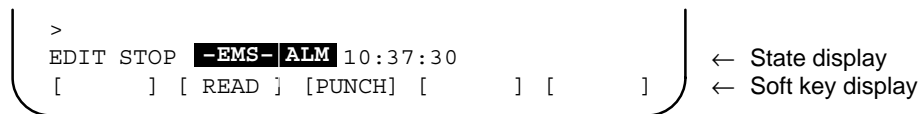

- (5) Pressing the **[READ]** soft key changes the soft key display as shown below:



- (6) Press the **[EXEC]** soft key to start inputting parameters from the input/output device. When parameters are being input, “INPUT” blinks in the state display field on the lower part of the screen.

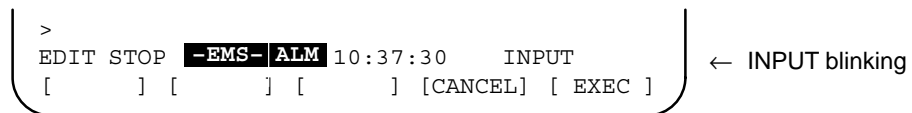

- (7) When parameter input terminates, “INPUT” stops blinking. Press the RESET key to interrupt parameter input.
- (8) When parameter read terminates, “INPUT” stops blinking, and an alarm condition (P/S000) occurs in the NC. Turn it off before continuing operation.

4 DESCRIPTION OF PARAMETERS

Parameters are classified by data type as follows:

Table 4 Data Types and Valid Data Ranges of Parameters

Data type	Valid data range	Remarks
Bit	0 or 1	
Bit axis		
Byte	0 to ± 127	In some parameters, signs are ignored.
Byte axis	0 to 255	
Word	0 to ± 32767	In some parameters, signs are ignored.
Word axis	0 to 65535	
2-word	0 to ± 99999999	
2-word axis		

NOTE

- 1 For the bit type and bit axis type parameters, a single data number is assigned to 8 bits. Each bit has a different meaning.
- 2 The axis type allows data to be set separately for each control axis.
- 3 The valid data range for each data type indicates a general range. The range varies according to the parameters. For the valid data range of a specific parameter, see the explanation of the parameter.

(1) Notation of bit type and bit axis type parameters

[Example]

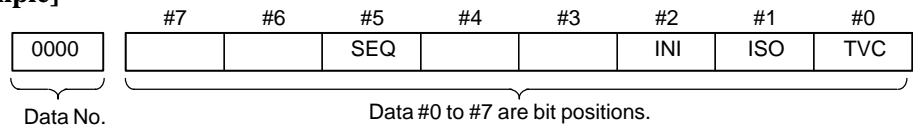

(2) Notation of parameters other than bit type and bit axis type

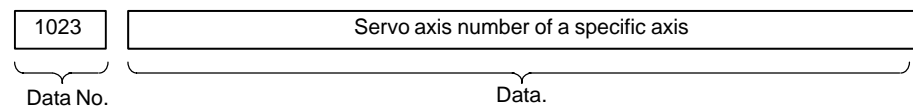

NOTE

- 1 The bits left blank in 4. DESCRIPTION OF PARAMETERS and parameter numbers that appear on the display but are not found in the parameter list are reserved for future expansion. They must always be 0.
- 2 Parameters having different meanings between the T series and M series and parameters that are valid only for the T or M series are indicated in two levels as shown below. Parameters left blank are unavailable.

Example1

Parameter 5010 has different meanings for the T series and M series.

5010	Tool nose radius compensation ...	T series
	Tool compensation C ...	M series

Example2

DPI is a parameter common to the M and T series, but GSB and GSC are parameters valid only for the T series.

3401	#7 GSC	#6 GSB	#0 DPI	T series
			DPI	M series

Example3

The following parameter is provided only for the M series.

1450		T series
	F1 digit feed ...	M series

4.1 PARAMETERS OF SETTING

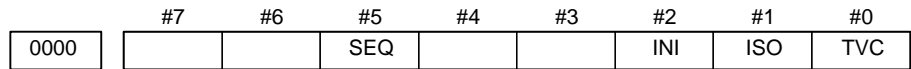

Setting entry is acceptable.

[Data type] Bit

- TVC** TV check
0 : Not performed
1 : Performed

- ISO** Code used for data output
0 : EIA code
1 : ISO code

- INI** Unit of input
0 : In mm
1 : In inches

- SEQ** Automatic insertion of sequence numbers
0: Not performed
1: Performed

NOTE

When a program is prepared by using MDI keys in the part program storage and edit mode, a sequence number can automatically be assigned to each block in set increments. Set the increment to parameter 3216.

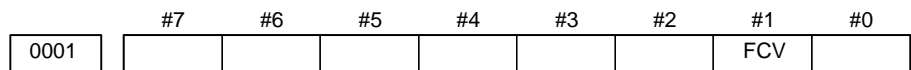

Setting entry is acceptable.

[Data type] Bit

- FCV** Tape format
0: Series 16 standard format
1: Series 15 format

NOTE

Programs created in the Series 15 tape format can be used for operation on the following functions:

- 1 Subprogram call M98
- 2 Thread cutting with equal leads G32 (T series)
- 3 Canned cycle G90, G92, G94 (T series)
- 4 Multiple repetitive canned cycle G71 to G76 (T series)
- 5 Drilling canned cycle G73, G74, G76, G80 to G89 (M series)
- 6 Cutter compensation C (M series)

When the tape format used in the Series 15 is used for this CNC, some limits may add. Refer to the Series 16i/18i /160i/180i-MODEL A OPERATOR'S MANUAL .

	#7	#6	#5	#4	#3	#2	#1	#0
0002								RDG
	SJZ							RDG

Setting entry is acceptable.

[Data type] Bit

RDG Remote diagnosis is

0: Not performed.

1: Performed.

To use an RS-232C serial port for performing remote diagnosis, connect and setup the modem, cable, and the like, then set 1 in this parameter. When using a modem card, the setting is not necessary.

SJZ Manual reference position si performed as follows:

0 : When no reference position has been set, reference position return is performed using deceleration dogs. When a reference position is already set, reference position return is performed using rapid traverse and deceleration dogs are ignored.

1 : Reference position return is performed using deceleration dogs at all times.

Note

SJZ is enabled when bit 3 (HJZ) of parameter No.1005 is set to 1. When a reference position is set without a dog, (i.e. when bit 1 (DLZ) of parameter No.1002 is set to 1 or bit 1 (DLZx) of parameter No.1005 is set to 1) reference position return after reference position setting is performed using rapid traverse at all times, regardless of the setting of SJZ.

	#7	#6	#5	#4	#3	#2	#1	#0
0012	RMVx			AIC				MIRx
	RMVx							MIRx

Setting entry is acceptable.

[Data type] Bit axis

MIRx Mirror image for each axis

0 : Mirror image is off.

1 : Mirror image is on.

AIC The travel distance of an axis command is:

0: Determined by the value specified with the address.

1: Always handled as an incremental value.

RMVx Releasing the assignment of the control axis for each axis

0 : Not released

1 : Released

NOTE

RMVx is valid when RMBx in parameter 1005#7 is 1.

0020	I/O CHANNEL: Selection of an input/output device or selection of input device in the foreground
------	---

Setting entry is acceptable.

[Data type] Byte

[Valid data range] 0 to 35

I/O CHANNEL: Selection of the input/output device to be used

The CNC provides the following interfaces for data transfer to and from the host computer and external input/output devices:

- Input/output device interface (RS-232C serial port 1, 2)
- Remote buffer interface (RS-232C/RS-422)
- DNC1/DNC2 interface

In addition, data can be transferred to and from the Power Mate via the FANUC I/O Link.

This parameter selects the interface used to transfer data to and from an input/output device.

Setting	Description								
0, 1	RS-232C serial port 1								
2	RS-232C serial port 2								
3	Remote buffer interface								
4	Memory card interface								
5	Data server interface								
6	The DNC operation is performed or M198 is specified by FOCAS1/Ethernet or DNC1/Ethernet.								
10	DNC1/DNC2 interface, OSI-Ethernet								
12	DNC1 interface #2								
15	M198 is specified by FOCAS1/HSSB. (Bit 1 (NWD) of parameter No. 8706) must also be specified.)								
16	The DNC operation is performed or M198 is specified by FOCAS1/HSSB (port 2).								
20 21 22 34 35	<table style="border: none;"> <tr> <td style="padding-right: 10px;">Group 0</td> <td rowspan="6" style="font-size: 3em; padding: 0 10px;">}</td> <td rowspan="6">Data is transferred between the CNC and a Power Mate in group n (n: 0 to 15) via the FANUC I/O Link.</td> </tr> <tr> <td>Group 1</td> </tr> <tr> <td>Group 2</td> </tr> <tr> <td> </td> </tr> <tr> <td>Group 14</td> </tr> <tr> <td>Group 15</td> </tr> </table>	Group 0	}	Data is transferred between the CNC and a Power Mate in group n (n: 0 to 15) via the FANUC I/O Link.	Group 1	Group 2		Group 14	Group 15
Group 0	}	Data is transferred between the CNC and a Power Mate in group n (n: 0 to 15) via the FANUC I/O Link.							
Group 1									
Group 2									
Group 14									
Group 15									

Supplemental remark 1

If the DNC operation is performed with FOCAS1/HSSB, the setting of parameter No. 20 does not matter. The DMMC signal <G042.7> is used.

Supplemental remark 2

If bit 0 (IO4) of parameter No. 110 is set to control the I/O channels separately, the I/O channels can be divided into four types: input and output in the foreground and input and output in the background. If so, parameter No. 20 becomes a parameter for selecting the input device in the foreground.

NOTE

- 1 An input/output device can also be selected using the setting screen. Usually, the setting screen is used.
- 2 The specifications (such as the baud rate and the number of stop bits) of the input/output devices to be connected must be set in the corresponding parameters for each interface beforehand. (See Section 4.2.) I/O CHANNEL = 0 and I/O CHANNEL = 1 represent input/output devices connected to RS-232C serial port 1. Separate parameters for the baud rate, stop bits, and other specifications are provided for each channel.

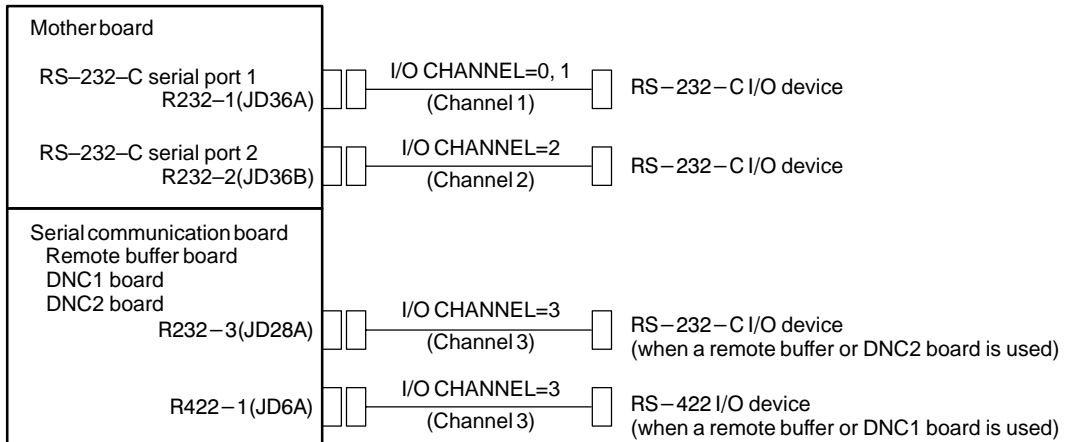

- 3 The input/output unit interface may be referred to as the reader/punch interface. RS-232C serial port 1 and RS-232C serial port 2 are also referred to as channel 1 and channel 2, respectively. The remote buffer interface is also referred to as channel 3.

0021	Setting of the output device in the foreground
0022	Setting of the input device in the background
0023	Setting of the output device in the background

Setting entry is acceptable.

[Data type] Byte

[Valid data range] 0 to 3, 5, 10

These parameters are valid only when bit 0 (IO4) of parameter No. 110 is set to control the I/O channels separately.

The parameters set individual input/output devices if the I/O channels are divided into these four types: input and output in the foreground and input and output in the background. The input device in the foreground is set in parameter No. 20. For the details of the settings, see the table provided with the description of parameter No. 20.

NOTE

If different input/output devices are simultaneously used in the foreground and background, just a value from 0 to 3 can be specified for the background device.

If an attempt is made to use a busy input/output device, an alarm (P/S233 or BP/S233) will be raised. Note that the settings 0 and 1 indicate the same input/output device.

4.2 PARAMETERS OF READER/PUNCHER INTERFACE, REMOTE BUFFER, DNC1, DNC2, AND M-NET INTERFACE

This CNC has three channels of input/output device interfaces. The input/output device to be used is specified by setting the channel connected to that device in setting parameter I/O CHANNEL. The specified data, such as a baud rate and the number of stop bits, of an input/output device connected to a specific channel must be set in parameters for that channel in advance. For channel 1, two combinations of parameters to specify the input/output device data are provided. The following shows the interrelation between the input/output device interface parameters for the channels.

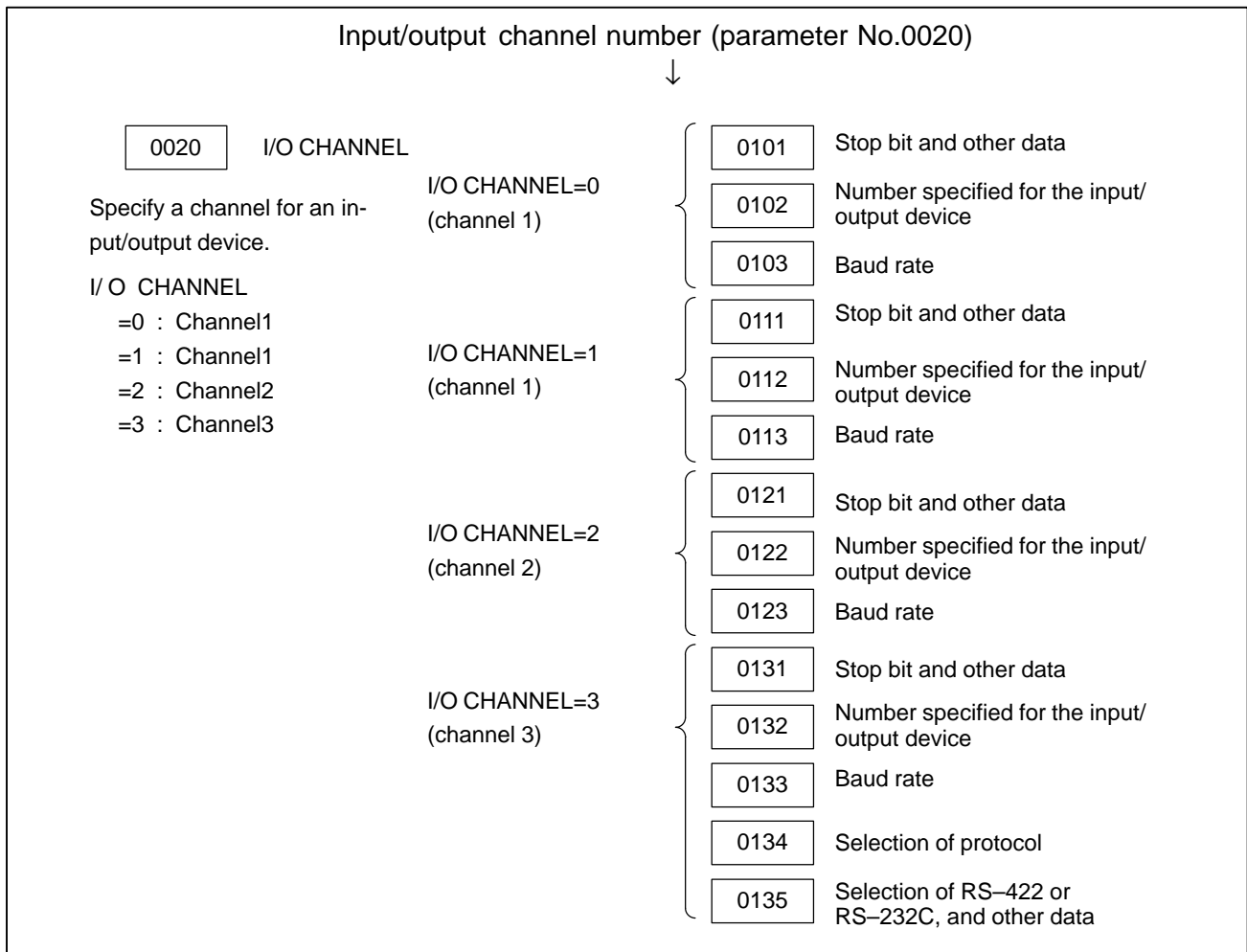

Fig.4.2 I/O Device Interface Settings

4.2.1 Parameters Common to all Channels

0024	Port for communication with the PMC ladder development tool (FAPT LADDER-II/III)
------	--

[Data type] Byte

This parameter sets the port to be used for communication with the PMC ladder development tool (FAPT LADDER-II/III).

- 0 : HSSB (COP7)
- 1 : RS-232C serial port 1 (JD36A)
- 2 : RS-232C serial port 2 (JD36B)
- 3 : Remote buffer interface (RS-232C) (JD28A)

	#7	#6	#5	#4	#3	#2	#1	#0
0100	ENS	IOP	ND3		NCR	CRF	CTV	

Setting entry is acceptable.

[Data type] Bit

CTV: Character counting for TV check in the comment section of a program.
 0 : Performed
 1 : Not performed

CRF EOB (end of block) to be output in the ISO code:
 0: Depends on the setting of bit 3 (NCR) of parameter No. 100.
 1: is "CR""LF".

Note) The EOB output patterns are as shown below:

NCR	CRF	EOB output format
0	0	"LF" "CR" "CR"
0	1	"CR" "LF"
1	0	"LF"
1	1	"CR" "LF"

NCR Output of the end of block (EOB) in ISO code
 0 : LF, CR, CR are output.
 1 : Only LF is output.

ND3 In DNC operation, a program is:
 0 : Read block by block. (A DC3 code is output for each block.)
 1 : Read continuously until the buffer becomes full. (A DC3 code is output when the buffer becomes full.)

NOTE

In general, reading is performed more efficiently when ND3 set to 1. This specification reduces the number of buffering interruptions caused by reading of a series of blocks specifying short movements. This in turn reduces the effective cycle time.

IOP Specifies how to stop program input/output operations.
 0 : An NC reset can stop program input/output operations.
 1 : Only the [STOP] soft key can stop program input/output operations. (An reset cannot stop program input/output operations.)

ENS Action taken when a NULL code is found during read of EIA code
 0 : An alarm is generated.
 1 : The NULL code is ignored.

	#7	#6	#5	#4	#3	#2	#1	#0
0110								IO4

[Data type] Bit

IO4 Separate control of I/O channel numbers is:
 0: Not performed.
 1: Performed.

If the I/O channels are not separately controlled, set the input/output device in parameter No. 20.

If the I/O channels are separately controlled, set the input device and output device in the foreground and the input device and output device in the background in parameters No. 20 to No. 23 respectively.

Separate control of I/O channels makes it possible to perform background editing, program input/output, and the like during the DNC operation.

**4.2.2
 Parameters of
 Channel 1
 (I/O CHANNEL=0)**

	#7	#6	#5	#4	#3	#2	#1	#0
0101	NFD				ASI			SB2
	NFD				ASI		HAD	SB2

[Data type] Bit type

SB2 The number of stop bits
 0 : 1
 1 : 2

HAD An alarm raised for the internal handy file is:
 0: Not displayed in detail on the NC screen. (PS alarm 86 is displayed.)
 1: Displayed in detail on the NC screen.

ASI Code used at data input
 0 : EIA or ISO code (automatically distinguished)
 1 : ASCII code

NFD Feed before and after the data at data output
 0 : Output
 1 : Not output

NOTE
 When input/output devices other than the FANUC PPR are used, set NFD to 1.

0102	Number specified for the input/output device (when the I/O CHANNEL is set to 0)
------	---

[Data type] Byte

Set the number specified for the input/output device used when the I/O CHANNEL is set to 0, with one of the set values listed in Table 4.2 (a).

Table 4.2.2 (a) Set value and Input/Output Device

Set value	Input/output device
0	RS-232-C (Used control codes DC1 to DC4)
1	FANUC CASSETTE ADAPTOR 1 (FANUC CASSETTE B1/ B2)
2	FANUC CASSETTE ADAPTOR 3 (FANUC CASSETTE F1)
3	FANUC PROGRAM FILE Mate, FANUC FA Card Adaptor FANUC FLOPPY CASSETTE ADAPTOR, FANUC Handy File FANUC SYSTEM P-MODEL H
4	RS-232-C (Not used control codes DC1 to DC4)
5	Portable tape reader
6	FANUC PPR FANUC SYSTEM P-MODEL G, FANUC SYSTEM P-MODEL H

0103	Baud rate (when the I/O CHANNEL is set to 0)
------	--

[Data type] Byte

Set baud rate of the input/output device used when the I/O CHANNEL is set to 0, with a set value in Table 4.2 (b).

Table 4.2.2 (b)

Set value	Baud rate (bps)	Set value	Baud rate (bps)
1	50	7	600
2	100	8	1200
3	110	9	2400
4	150	10	4800
5	200	11	9600
6	300	12	19200

4.2.3

Parameters of Channel 1 (I/O CHANNEL=1)

	#7	#6	#5	#4	#3	#2	#1	#0
0111	NFD				ASI			SB2

[Data type] Bit

These parameters are used when I/O CHANNEL is set to 1. The meanings of the bits are the same as for parameter 0101.

0112	Number specified for the input/output device (when I/O CHANNEL is set to 1)
------	---

[Data type] Byte

Set the number specified for the input/output device used when the I/O CHANNEL is set to 1, with one of the set values listed in Table 4.2 (a).

0113	Baud rate (when I/O CHANNEL is set to 1)
------	--

[Data type] Byte

Set the baud rate of the input/output device used when I/O CHANNEL is set to 1, with a value in Table 4.2 (b).

**4.2.4
Parameters of
Channel 2
(I/O CHANNEL=2)**

	#7	#6	#5	#4	#3	#2	#1	#0
0121	NFD				ASI			SB2

[Data type] Bit

These parameters are used when I/O CHANNEL is set to 2. The meanings of the bits are the same as for parameter 0101.

0122	Number specified for the input/output device (when I/O CHANNEL is set to 2)
------	---

[Data type] Byte

Set the number specified for the input/output device used when I/O CHANNEL is set to 2, with a value in Table 4.2 (a).

0123	Baud rate (when the I/O CHANNEL is set to 2)
------	--

[Data type] Byte

Set the baud rate of the input/output device used when I/O CHANNEL is set to 2, with a value in Table 4.2 (b).

**4.2.5
Parameters of
Channel 3
(I/O CHANNEL=3)**

	#7	#6	#5	#4	#3	#2	#1	#0
0131	NFD				ASI			SB2

NOTE
When this parameter is set, the power must be turned off before operation is continued.

[Data type] Bit

These parameters are used when I/O CHANNEL is set to 3. The meanings of the bits are the same as for parameter 0101.

0132	Number specified for the input/output device (when I/O CHANNEL is set to 3)
------	---

NOTE
When this parameter is set, the power must be turned off before operation is continued.

[Data type] Byte

Set the number specified for the input/output device used when I/O CHANNEL is set to 3, with a number in Table 4.2 (a).

0133	Baud rate (when the I/O CHANNEL is set to 3)
------	--

NOTE
When this parameter is set, the power must be turned off before operation is continued.

[Data type] Byte

Set the baud rate of the input/output device used when the I/O CHANNEL is set to 3 according to the table 4.2 (c).

Valid data range: 1 to 15 (up to a baud rate of 86400 bps) for the RS-422 interface or 1 to 12 (up to a baud rate of 19200 bps) for the RS-232C interface.

Table 4.2.5 Baud Rate Settings

Set value	Baud rate (bps)	Set value	Baud rate (bps)
1	50	9	2400
2	100	10	4800
3	110	11	9600
4	150	12	19200
5	200	13	38400
6	300	14	76800
7	600	14	86400
8	1200		

	#7	#6	#5	#4	#3	#2	#1	#0
0134			CLK	NCD		SYN	PRY	

NOTE
When this parameter is set, the power must be turned off before operation is continued.

[Data type] Bit

PRY Parity bit
0: Not used
1: Used

SYN Reset/alarm in protocol B
0: Not reported to the host
1: Reported to the host with SYN and NAK codes

NCD CD (signal quality detection) of the RS-232C interface
0: Checked
1: Not checked

CLK Baud rate clock when the RS-422 interface is used
0: Internal clock
1: External clock

NOTE
When the RS-232C interface is used, set this bit to 0.

	#7	#6	#5	#4	#3	#2	#1	#0
0135	RMS				R42	PRA	ETX	ASC

NOTE

When this parameter is set, the power must be turned off before operation is continued.

[Data type] Bit

ASC Communication code except NC data

- 0: ISO code
- 1: ASCII code

ETX End code for protocol A or extended protocol A

- 0: CR code in ASCII/ISO
- 1: ETX code in ASCII/ISO

NOTE

Use of ASCII/ISO is specified by ASC.

PRA Communication protocol

- 0: Protocol B
- 1: Protocol A

R42 Interface

- 0: RS-232C interface
- 1: RS-422 interface

RMS State of remote/tape operation when protocol A is used

- 0: Always 0 is returned.
- 1: Contents of the change request of the remote/tape operation in the SET command from the host is returned.

	#7	#6	#5	#4	#3	#2	#1	#0
0138	MDN						FNL	MDP

[Data type] Bit

MDP In data output by a memory card, the series information is:

- 0: Not added to the output file name.
- 1: Added to the output file name.

PNL In data output by RS-232C of the loader control function, the series information is:

- 0: Not added to the output file name.
- 1: Added to the output file name.

MDN The DNC operation function by a memory card is:

- 0: Disabled.
- 1: Enabled. (A PCMCIA card attachment is required.)

NOTE

Use a PCMCIA card attachment suited to the CNC to secure the memory card in the CNC.

4.3 PARAMETERS OF DNC1/DNC2 INTERFACE

	#7	#6	#5	#4	#3	#2	#1	#0
0140					ECD	NCE		BCC

NOTE

When this parameter is set, the power must be turned off before operation is continued.

[Data type] Bit

BCC The BCC value (block check characters) for the DNC2 interface is:
0: Checked.
1: Not checked.

Even if the BCC value is not checked, the BCC value itself must be specified.

NCE The ER (RS-232C) and TR (RS422) signals are:
0: Checked.
1: Not checked.

ECD Error code of negative acknowledgment
0: A four-digit hexadecimal error code is added to a negative acknowledgment.
1: No error code is added to a negative acknowledgment.

NOTE

To use FANUC DNC2 communications library for the host computer, set this parameter to 1.

0141	System for connection between the CNC and host (DNC1 interface)
------	---

NOTE

When this parameter is set, the power must be turned off before operation is continued.

[Data type] Byte

[Valid data range] 1 or 2

This parameter specifies the system for connection (DNC1 interface) between the CNC and host.

Set value

1 : Point-to-point connection

2 : Multipoint connection

0142	Station address of the CNC (DNC1 interface)
------	---

NOTE

When this parameter is set, the power must be turned off before operation is continued.

[Data type] Byte

[Valid data range] 2 to 52

This parameter specifies the station address of the CNC when the CNC is connected via the DNC1 interface using multipoint connection.

0143

Time limit specified for the timer monitoring a response (DNC2 interface)

NOTE

When this parameter is set, the power must be turned off before operation is continued.

[Data type] Byte

[Unit of data] S

[Valid data range] 1 to 60 (The standard setting is 3.)

0144

Time limit specified for the timer monitoring the EOT signal (DNC2 interface)

NOTE

When this parameter is set, the power must be turned off before operation is continued.

[Data type] Byte

[Unit of data] S

[Valid data range] 1 to 60 (The standard setting is 5.)

0145

Time required for switching RECV and SEND (DNC2 interface)

NOTE

When this parameter is set, the power must be turned off before operation is continued.

[Data type] Byte

[Unit of data] S

[Valid data range] 1 to 60 (The standard setting is 1.)

0146

Number of times the system retries holding communication (DNC2 interface)

NOTE

When this parameter is set, the power must be turned off before operation is continued.

[Data type] Byte

[Unit of data] S

[Valid data range] 1 to 10 (The standard setting is 3.)

Set the maximum number of times the system retries holding communication with the remote device if the remote device uses an invalid protocol in the data-link layer or the remote device does not respond to the request.

0147	Number of times the system sends the message in response to the NAK signal (DNC2 interface)
------	---

NOTE
When this parameter is set, the power must be turned off before operation is continued.

[Data type] Byte

[Unit of data] Number of times

[Valid data range] 1 to 10 (The standard setting is 2.)

Set the maximum number of times the system retries sending the message in response to the NAK signal.

0148	Number of characters in overrun (DNC2) interface
------	--

NOTE
When this parameter is set, the power must be turned off before operation is continued.

[Data type] Byte

[Valid data range] 10 to 225 (The standard setting is 10.)

Set the number of characters the system can receive after transmission is stopped (CS off).

0149	Number of characters in the data section of the communication packet (DNC2 interface)
------	---

NOTE
When this parameter is set, the power must be turned off before operation is continued.

[Data type] Word

[Valid range] 80 to 256 (The standard setting is 256.)

The standard setting is 256. If the specified value is out of range, a value of 80 or 256 is used.

This parameter determines the maximum length of the packet used in transmission over the DNC2 interface. Including the two characters at the start of the packet, the four characters used for a command, and the three characters at the end, the maximum number of characters in the packet is nine plus the number specified in parameter No.0149.

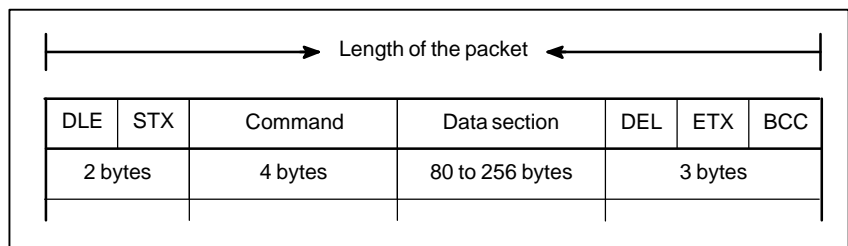

4.4 PARAMETERS OF M-NET INTERFACE

	#7	#6	#5	#4	#3	#2	#1	#0
0161	SRS		PEO	SRP		SRL		

NOTE
When this parameter is set, the power must be turned off before operation is continued.

[Data type] Bit

SRL Number of characters used in the serial interface
0: Seven bits
1: Eight bits

SRP Vertical parity in the serial interface
0: Vertical parity is not checked.
1: Vertical parity is checked.

PEO Either odd or even parity is used for vertical parity in the serial interface
0: Odd parity is used.
1: Even parity is used.

NOTE
This bit is effective when bit SRP is set to 1.

SRS Stop bit in the serial interface
0: One stop bit is used.
1: Two stop bits are used.

0171	Length of DI data in bytes in M-NET
------	-------------------------------------

NOTE
When this parameter is set, the power must be turned off before operation is continued.

[Data type] Byte

[Valid range] 1 to 32

Specify the length of DI data in bytes (number of byte of data actually transferred from the PLC unit to the CNC unit) in the serial interface.

0172	Length of DO data in bytes in M-NET
------	-------------------------------------

NOTE
When this parameter is set, the power must be turned off before operation is continued.

[Data type] Byte

[Valid range] 1 to 32

Specify the length of DO data in bytes (number of bytes of data actually transferred from the CNC unit to the PLC unit) in the serial interface.

NOTE

When a self-loop test is performed, specify the same value in parameters No.0171 and No.0172.

0173

Station address in M-NET

NOTE

When this parameter is set, the power must be turned off before operation is continued.

[Data type] Byte

[Valid range] 1 to 15

Specify a station address in the serial interface.

0174

Baud rate in M-NET

NOTE

When this parameter is set, the power must be turned off before operation is continued.

[Data type] Byte

[Valid range] 0 to 6 (The standard setting is 3.)

Specify a baud rate for the serial interface.

Setting	Baud rate (bps)
1	2400
2	4800
3	9600
4	19200
5	38400
6	57600
7	76800

0175

Time required for connecting two stations in M-NET

NOTE

When this parameter is set, the power must be turned off before operation is continued.

[Data type] Word

[Unit of data] ms

[Valid range] 1 to 32767 (The standard setting is 10000.)

Specify a time limit from when the connection sequence is completed for the self-station to when the normal transfer sequence starts in the serial interface.

0176

Time required for polling in M-NET

NOTE

When this parameter is set, the power must be turned off before operation is continued.

[Data type] Word

[Unit of data] ms

[Valid data range] 1 to 32767 (The standard setting is 500.)

Specify a time limit for polling in the normal sequence at the self-station in the serial interface.

0177

Time required from SAI to BCC in M-NET

NOTE

When this parameter is set, the power must be turned off before operation is continued.

[Data type] Word

[Unit of data] ms

[Valid data range] 1 to 32767 (The standard setting is 50.)

Specify a time limit from when the SAI signal starts to be transferred to when the BCC signal has been sent.

0178

Time between a reception and the next transmission in M-NET

NOTE

When this parameter is set, the power must be turned off before operation is continued.

[Data type] Word

[Unit of data] ms

[Valid data range] 1 to 32767 (The standard setting is 1.)

Specify the time from when data has been received to when the next data starts to be transmitted.

4.5 PARAMETERS OF REMOTE DIAGNOSIS

	#7	#6	#5	#4	#3	#2	#1	#0
0002								RDG

[Data type] Bit

RDG Remote diagnosis is:
0: Not performed.
1: Performed.

If an RS-232C serial port is used to carry out remote diagnosis, connect and set up the modem, cable, and the like, then set 1 in this parameter. When using a modem card, the setting is not necessary.

	#7	#6	#5	#4	#3	#2	#1	#0
0201		MCB				NCR	ASC	SB2

[Data type] Bit

SB2 The number of stop bits is
0: 1.
1: 2.

To carry out remote diagnosis, set 0.

ASC The code to be used for data output is:
0: ISO code.
1: ASCII code.

To carry out remote diagnosis, set 1.

NCR EOB (end of block) is output as:
0: "LF""CR""CR".
1: Just as "LF".

To carry out remote diagnosis, set 1.

MCB The baud rate setting for data input/output between the modem card and CNC is:

0: 9600 bps (fixed).

1: Determined by the setting of parameter No. 203.

For the detailed setting while MCB is set to 1, see parameter No. 203.

0203

Baud rate (for remote diagnosis)

[Data type] Byte

Set the baud rate of data input/output by remote diagnosis, with reference to the tables given below.

When using an RS-232C serial port

Setting	Baud rate (bps)	Setting	Baud rate (bps)
1	50	7	600
2	100	8	1200
3	110	9	2400
4	150	10	4800
5	200	11	9600
6	300	12	19200

When using a modem card (when bit 6 (MCB) of parameter No. 201 is set to 1)

Setting	Baud rate (bps)	Setting	Baud rate (bps)
1	28800	7	600
2	38400	8	1200
3	57600	9	2400
4	—	10	4800
5	—	11	9600
6	300	12	19200

NOTE

The tables above indicate the baud rates of communication between the CNC and modem. The actual communication baud rate may be lowered, depending on the modem and communication line.

0204

Remote diagnosis channel

[Data type] Byte**[Valid data range]** 0, 1, 2

The interface to be used for remote diagnosis is:

0, 1: RS-232C serial port 1 (channel 1).

2 : RS-232C serial port 2 (channel 2).

To carry out remote diagnosis using RS-232C, the reader/punch interface is required.

0211	Password 1 for remote diagnosis
0212	Password 2 for remote diagnosis
0213	Password 3 for remote diagnosis

[Valid data range] 1 to 99999999

Specify a password for using the remote diagnosis function.

The remote diagnosis function has the following password settings. Data can be protected by preventing a third party from accessing any system parameter or machining program without permission.

Password 1:

Set a password for the whole service of the remote diagnosis function. (The whole remote diagnosis service is available only when this password is input on the host side (PC, for instance).)

Password 2:

Set a password of a part program. (The input/output, verification, and the like of a program are possible only when this password is input on the host side (PC, for instance).)

Password 3:

Set a password of a parameter. (The input/output or the like of a parameter is possible only when this password is input on the host side (PC, for instance).)

NOTE

Once any value other than 0 is specified as a password, the password can be changed only when the same value is specified in the corresponding keyword (parameters No. 221 to No. 223). If any value other than 0 is specified as a password, the password setting is not displayed on the parameter screen (blank display is provided). Take great care when setting the password.

0221	Keyword 1 for remote diagnosis
0222	Keyword 2 for remote diagnosis
0223	Keyword 3 for remote diagnosis

[Valid range] 1 to 99999999

Set a keyword corresponding to a password of the remote diagnosis function.

Keyword 1: Keyword for password 1 (parameter No. 211)

Keyword 2: Keyword for password 2 (parameter No. 212)

Keyword 3: Keyword for password 3 (parameter No. 213)

If any value other than 0 is specified as a password (parameters No. 211 to No. 213), the password can be changed only when the same value is specified as the corresponding keyword.

NOTE

The keyword value is reset to 0 at power-up.
On the parameter screen, the keyword setting is not displayed (blank display is provided).

4.6 PARAMETERS OF DNC1 INTERFACE

	#7	#6	#5	#4	#3	#2	#1	#0
0231	NFD				ASI			SB2

NOTE

When this parameter is set, the power must be turned off before operation is continued.

[Data type]

SB2 Number of stop bits

0: 1 bit

1: 2 bits

ASI Data input code

0: IEA or ISO (automatic recognition)

1: ASCII Code

NFD When data is out, feed holes are

0: Output before and after data section

1: Not output

0233	Baud rate (DNC1 interface #2)
------	-------------------------------

NOTE

When this parameter is set, the power must be turned off before operation is continued.

[Data type] Byte

[Valid data range] 1 to 15

Baud rate

Set value	Baud rate (bps)
1	50
2	100
3	110
4	150
5	200

Set value	Baud rate (bps)
6	300
7	600
8	1200
9	2400
10	4800

Set value	Baud rate (bps)
11	9600
12	19200
13	38400
14	76800
15	86400

0241	Mode of connection between the host and CNC (DNC1 interface #2)
------	---

NOTE

When this parameter is set, the power must be turned off before operation is continued.

[Data type] Byte

[Valid data range] 1 to 2

This parameter sets the mode of connection between the host and CNC.

Setting	Mode
1	Point-to-pointmode
2	Multipointmode

0242

CNC station address (DNC 1 interface #2)

NOTE

When this parameter is set, the power must be turned off before operation is continued.

[Data type] Byte

[Valid data range] 2 to 52

This parameter sets a CNC station address when the CNC is to be connected in the multipoint mode.

4.7 PARAMETER OF MEMORY CARD INTERFACE

	#7	#6	#5	#4	#3	#2	#1	#0
0300								PCM

[Data type] Bit

PCM If the CNC screen display function is enabled, when a memory card interface is provided on the NC side (HSSB connection),
 0 : The memory card interface on the NC side is used.
 1 : The memory card interface on the PC side is used.

Series 160*i*, which incorporates a PC, performs data input/output to and from the PC, irrespective of this parameter setting. If this parameter is set to 0 while the HSSB board is used for connection, the I/O channel specified in parameter No. 0020 is used.

If this parameter is set to 1, data input/output from and to the PC is performed irrespective of the setting of parameter No. 20. This parameter is valid only while the CNC screen display function is active.

4.8 PARAMETERS OF FACTOLINK



[Data type] Bit

SB2 The number of stop bits is:
 0 : 1 bit.
 1 : 2 bits.

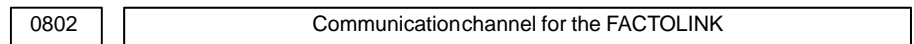

[Data type] Byte

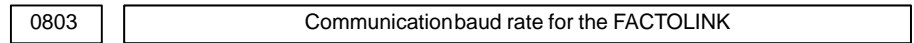

[Data type] Byte

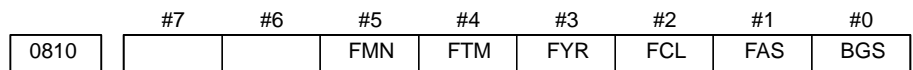

[Data type] Bit

- BGS** When the FACTOLINK screen is not displayed, FACTOLINK alarm task communication is:
 0 : Not activated.
 1 : Activated.
- FAS** If FACTOLINK uses the Answer or AnswerEx command, the answer number A01. is:
 0: Displayed in the answer field.
 1: Not displayed in the answer field.
- FCL** The FACTOLINK clock is:
 0: Not displayed in reverse video.
 1: Displayed in reverse video.
- FYR** In the FACTOLINK clock display, years in the 99/01/23 00:00 format (bit 4 (FTM) of parameter No. 810 set to 1) are represented:
 0: By a two-digit number.
 1: By a four-digit number.
- FTM** The FACTOLINK clock is displayed in this format:
 0: Wed Nov 12 00:00:00
 1: 97/11/12 00:00:00
- FMN** The FACTOLINK screen is displayed:
 0: In color.
 1: With two levels of gray.

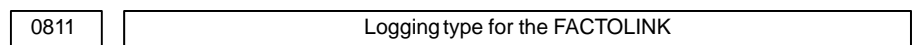

[Data type] Byte

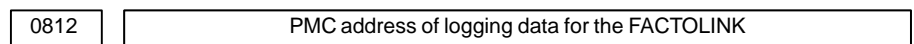

[Data type] Word

0813	Logging data length for the FACTOLINK
------	---------------------------------------

[Data type] Word

0814	Logging wait address for the FACTOLINK
------	--

[Data type] Word

0815	FACTOLINK logging data transmission interval
------	--

[Data type] 2-word

0820	FACTOLINK device address (1)
0821	FACTOLINK device address (2)
0822	FACTOLINK device address (3)
0823	FACTOLINK device address (4)
0824	FACTOLINK device address (5)
0825	FACTOLINK device address (6)
0826	FACTOLINK device address (7)
0827	FACTOLINK device address (8)
0828	FACTOLINK device address (9)

[Data type] Byte

See following manuals for the parameters related to the FACTOLINK.

- FANUC Ethernet Board/DATA SERVER Board OPERATOR'S MANUAL (B-63354EN)
- FANUC FACTOLINK SCRIPT FUNCTION OPERATOR'S MANUAL (B-75054EN)

4.9 PARAMETERS OF DATA SERVER

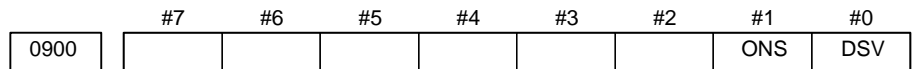

[Data type] Bit

DSV The data server function is
 0: Enabled
 1: Disabled

ONS When the O number of the data server file name and the O number in an NC program do not match:
 0: The O number of the file name takes priority.
 1: The O number in the NC program takes priority.

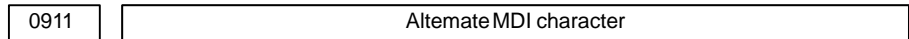

[Data type] Word

[Set value] ASCII code (decimal)

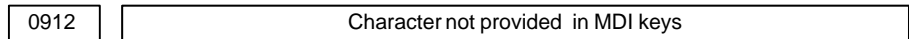

[Data type] Word

[Set value] ASCII code (decimal)

When specifying a character which is not provided as a MDI keys for HOST DIRECTORY of DATA SERVER SETTING-1, use these parameters to assign an alternative key to that character.

Examples

If ODSERVERONCPROG is specified for HOST DIRECTORY, you cannot enter “\” with the MDI keys. To use “@” as an alternative character, set 64 (ASCII code for @) in parameter No.0911 and 92 (ASCII code for \) in parameter No.0912.

When

“DSERVER@NCPROG”

is specified for HOST DIRECTORY, the data server converts it to “ODSERVERONCPROG”.

NOTE

When both parameters No.0911 and 0912 are set to 0, the data server assumes the following setting:

No.0911 = 32 (blank)

No.0912 = 92 (\)

0921	OS selected for host computer 1 of data server
------	--

0922	OS selected for host computer 2 of data server
------	--

0923	OS selected for host computer 3 of data server
------	--

[Data type] Word

[Valid data range] 0 to 1

1 : UNIX or VMS is selected.

0 : Windows95/98/NT is selected.

0924	Latency setting for DNC1/Ethernet or FOCAS1/Ethernet
------	--

[Data type] Word

[Unit of data] ms

[Valid data range] 0 to 255

Set service latency of DNC1/Ethernet or FOCAS1/Ethernet while DNC1/Ethernet or FOCAS1/Ethernet is used together with the data server function.

If a value between 0 and 2 is set, 2 ms is assumed.

4.10 PARAMETERS OF ETHERNET

0931	Special character code corresponding to soft key [CHAR-1]
0932	Special character code corresponding to soft key [CHAR-2]
0933	Special character code corresponding to soft key [CHAR-3]
0934	Special character code corresponding to soft key [CHAR-4]
0935	Special character code corresponding to soft key [CHAR-5]

[Data type] Byte

[Valid data range] 32 to 95

These parameters are provided to allow a special character that is not provided on the MDI panel but needed in a user name, password, or login DIR to be input by pressing a soft key on the Ethernet parameter screen.

If a value other than 0 is input as a parameter, the special character assigned to the corresponding input soft key [CHAR-1] to [CHAR-5] is displayed.

The special character codes correspond to the ASCII codes.

Sample special character codes

Special character	Code	Special character	Code	Special character	Code
Blank	32)	41	<	60
!	33	*	42	>	62
"	34	+	43	?	63
#	35	,	44	@	64
\$	36	-	45	[91
%	37	.	46	^	92
&	38	/	47	¥	93
'	39	:	58]	94
(40	;	59	_	95

4.11 PARAMETERS OF POWER MATE CNC MANAGER

	#7	#6	#5	#4	#3	#2	#1	#0
0960					PMN	MD2	MD1	SLV

[Data type] Bit

SLV When the power mate CNC manager is selected, the screen displays:
0 : One slave.
1 : Up to four slaves with the screen divided into four.

MD1,MD2 These parameters set a slave parameter input/output destination.

MD2	MD1	Input/output destination
0	0	Part program storage
0	1	Memory card

In either case, slave parameters are output in program format.

PMN The power mate CNC manager function is:
0 : Enabled.
1 : Disabled. (Communication with slaves is not performed.)

4.12 PARAMETERS OF AXIS CONTROL/ INCREMENT SYSTEM

	#7	#6	#5	#4	#3	#2	#1	#0
1001								INM

NOTE

When this parameter is set, the power must be turned off before operation is continued.

[Data type] Bit

INM Least command increment on the linear axis

0 : In mm (metric system machine)

1 : In inches (inch system machine)

	#7	#6	#5	#4	#3	#2	#1	#0
1002	IDG			XIK		SFD	DLZ	JAX
	IDG			XIK	AZR	SFD	DLZ	JAX

[Data type] Bit

JAX Number of axes controlled simultaneously in manual continuous feed, manual rapid traverse and manual reference position return

0 : 1 axis

1 : 3 axes

DLZ Function setting the reference position without dog

0 : Disabled

1 : Enabled (enabled for all axes)

NOTE

1 This function can be specified for each axis by DLZx, bit 1 of parameter No.1005.

2 For a system including an axis of Cs contour control or spindle positioning, avoid using this parameter. Use bit 1 (DLZx) of parameter No. 1005 instead to set just a required axis.

SFD The function for shifting the reference position is

0: Not used.

1: Used.

AZR When no reference position is set, the G28 command causes:

0: Reference position return using deceleration dogs (as during manual reference position return) to be expected.

1: P/S alarm No.090 to be issued.

NOTE

When reference position return without dogs is specified, (when bit 1 (DLZ) of parameter No.1002 is set to 1 or bit 1 (DLZx) of parameter No.1005 is set to 1) the G28 command specified before a reference position is set causes P/S alarm No.090 to be issued, regardless of the setting of AZR.

- XIK** When LRP, bit 1 of parameter No.1401, is set to 0, namely, when positioning is performed using non-linear type positioning, if an interlock is applied to the machine along one of axes in positioning,
- 0: The machine stops moving along the axis for which the interlock is applied and continues to move along the other axes.
1: The machine stops moving along all the axes.
- IDG** When the reference position is set without dogs, automatic setting of the IDGx parameter (bit 0 of parameter No.1012) to prevent the reference position from being set again is:
- 0 : Not performed.
1 : Performed.

	#7	#6	#5	#4	#3	#2	#1	#0
1004	IPR						ISC	
	IPR						ISC	ISA

NOTE

When this parameter is set, the power must be turned off before operation is continued.

[Data type] Bit

ISA, ISC The least input increment and least command increment are set.

ISC	ISA	Least input increment and least command increment	Symbol
0	0	0.001 mm, 0.001 deg, or 0.0001 inch	IS-B
0	1	0.01 mm, 0.01 deg, or 0.001 inch	IS-A
1	0	0.0001 mm, 0.0001 deg, or 0.00001 inch	IS-C

NOTE

IS-A cannot be used at present.

- IPR** Whether the least input increment for each axis is set to a value 10 times as large as the least command increment is specified, in increment systems of IS-B or IS-C at setting mm.
- 0: The least input increment is not set to a value 10 times as large as the least command increment.
1: The least input increment is set to a value 10 times as large as the least command increment.

If IPR is set to 1, the least input increment is set as follows:

Input increment	Least input increment
IS-B	0.01 mm, 0.01 deg, or 0.0001 inch
IS-C	0.001 mm, 0.001 deg, or 0.00001 inch

NOTE

For IS-A, the least input increment cannot be set to a value 10 times as large as the least command increment.
The least input increment is not multiplied by 10 also when the calculator-type decimal point input (bit 0 (DPI) of parameter No. 3401) is used.

	#7	#6	#5	#4	#3	#2	#1	#0
1005	RMBx	MCCx	EDMx	EDPx			DLZx	ZRNx
	RMBx	MCCx	EDMx	EDPx	HJZx		DLZx	ZRNx

[Data type] Bit axis

ZRNx When a command specifying the movement except for G28 is issued in automatic operation (MEM, RMT, or MDI) and when a return to the reference position has not been performed since the power was turned on
 0 : An alarm is generated (P/S alarm 224).
 1 : An alarm is not generated.

NOTE

- 1 The state in which the reference position has not been established refers to that state in which reference position return has not been performed after power-on when an absolute position detector is not being used, or that state in which the association of the machine position with the position detected with the absolute position detector has not been completed (see the description of bit 4 (APZx) of parameter No. 1815) when an absolute position detector is being used.
- 2 To use a function that establishes the reference point and makes a movement with a command other than G28, such as an axis of Cs contour control, set this parameter for the relative axis.

DLZx Function for setting the reference position without dogs
 0 : Disabled
 1 : Enabled

NOTE

- 1 When DLZ of parameter No.1002 is 0, DLZx is enabled. When DLZ of parameter No.1002 is 1, DLZx is disabled, and the function for setting the reference position without dogs is enabled for all axes.
- 2 Avoid setting this parameter for an axis of Cs contour control or spindle positioning.

HJZx When a reference position is already set:
 0 : Manual reference position return is performed with deceleration dogs.
 1 : Manual reference position return is performed using rapid traverse without deceleration dogs, or manual reference position return is performed with deceleration dogs, depending on the setting of bit 7 (SJZ) of parameter No.0002.

NOTE

When reference position return without dogs is specified, (when bit 1 (DLZ) of parameter No.1002 is set to 1 or bit (DLZx) of parameter No.1005 is set to 1) reference position return after a reference position is set is performed using rapid traverse, regardless of the setting of HJZ.

EDPx External deceleration signal in the positive direction for each axis
 0 : Valid only for rapid traverse
 1 : Valid for rapid traverse and cutting feed

EDMx External deceleration signal in the negative direction for each axis
 0 : Valid only for rapid traverse
 1 : Valid for rapid traverse and cutting feed

MCCx When an axis become the removal state using the controlled axis removal signal or setting:
 0: MCC is turned off
 1: MCC is not turned off. (Servo motor excitation is turned off, but the MCC signal of the servo amplifier is not turned off.)

NOTE

This parameter is used to remove only one axis, for example, when a two-axis or three-axis amplifier is used. When two-axis or three-axis amplifier is used and only one axis is removed, servo alarm No.401 (V-READY OFF) is usually issued. However, this parameter, when set to 1, prevents servo alarm No.401 from being issued. Note, however, that disconnecting a servo amplifier from the CNC will cause the servo amplifier to enter the V-READY OFF status. This is a characteristic of all multi-axis amplifiers.

RMBx Releasing the assignment of the control axis for each axis (signal input and setting input)
 0 : Invalid
 1 : Valid

	#7	#6	#5	#4	#3	#2	#1	#0
1006			ZMlx		DIAx		ROSx	ROTx
			ZMlx				ROSx	ROTx

NOTE

When this parameter is set, the power must be turned off before operation is continued.

[Data type] Bit axis

ROTx, ROSx Setting linear or rotation axis.

ROSx	ROTx	Meaning
0	0	Linear axis (1) Inch/metric conversion is done. (2) All coordinate values are linear axis type. (Is not rounded in 0 to 360°) (3) Stored pitch error compensation is linear axis type (Refer to parameter No.3624)
0	1	Rotation axis (A type) (1) Inch/metric conversion is not done. (2) Machine coordinate values are rounded in 0 to 360°. Absolute coordinate values are rounded or not rounded by parameter No.1008#0(ROAx) and #2(RRLx). (3) Stored pitch error compensation is the rotation type. (Refer to parameter No.3624) (4) Automatic reference position return (G28, G30) is done in the reference position return direction and the move amount does not exceed one rotation.

ROSx	ROTx	Meaning
1	0	Setting is invalid (unused)
1	1	Rotation axis (B type) (1) Inch/metric conversion, absolute coordinate values and relative coordinate values are not done. (2) Machine coordinate values, absolute coordinate values and relative coordinate values are linear axis type. (Is not rounded in 0 to 360°). (3) Stored pitch error compensation is linear axis type (Refer to parameter No.3624) (4) Cannot be used with the rotation axis roll over function and the index table indexing function (M series)

DIAX Either a diameter or radius is set to be used for specifying the amount of travel on each axis.

- 0 : Radius
- 1 : Diameter

ZMIx The direction of reference position return.

- 0 : Positive direction
- 1 : Negative direction

NOTE

The direction of the initial backlash, which occurs when power is switched on, is opposite to the direction of a reference position return.

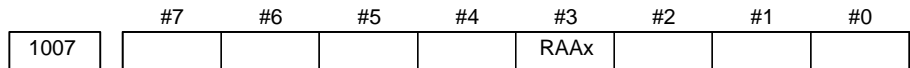

[Data type] Bit axis

RAAx When an absolute command is specified for a rotation axis:

- 0: The end point coordinates and direction of rotation conform to bit 1 (RABx) of parameter No.1008.
- 1: The end point coordinates conform to the absolute value of the value specified in the command. The rotational direction conforms to the sign of the value specified in the command.

NOTE

- 1 This parameter is valid when the rotary axis control function is provided and the rotation axis rollover function is applied (bit 0 (ROAx) of parameter No.1008 is set to 1).
- 2 This parameter is equal to bit 3 (RAAx) of parameter No.1008.

	#7	#6	#5	#4	#3	#2	#1	#0
1008					RAAx	RRLx	RABx	ROAx

NOTE

When this parameter is set, the power must be turned off before operation is continued.

[Data type] Bit axis

ROAx The roll-over function of a rotation axis is
 0 : Invalid
 1 : Valid

NOTE

ROAx specifies the function only for a rotation axis (for which ROTx, #0 of parameter No.1006, is set to 1)

RABx In the absolute commands, the axis rotates in the direction
 0 : In which the distance to the target is shorter.
 1 : Specified by the sign of command value.

NOTE

RABx is valid only when ROAx is 1.

RRLx Relative coordinates are
 0 : Not rounded by the amount of the shift per one rotation
 1 : Rounded by the amount of the shift per one rotation

NOTE

1 RRLx is valid only when ROAx is 1.
 2 Assign the amount of the shift per one rotation in parameter No.1260.

RAAx The rotation direction of a rotation axis and end point coordinates in the absolute command mode:
 0: Agree with the setting of bit 1 (RABx) of parameter No.1008.
 1: Agree with the absolute value of the specified value for the end point coordinates and the sign of the specified value for the rotation direction.

NOTE

This parameter is enabled when the rotary axis control function is provided and the rotation axis roll-over function is used (with bit 0 (ROAx) of parameter No.1008 set to 1).

1010	Number of CNC-controlled axes
------	-------------------------------

NOTE
When this parameter is set, the power must be turned off before operation is continued.

[Data type] Byte

[Valid data range] 1, 2, 3, ..., the number of controlled axes

Set the maximum number of axes that can be controlled by the CNC.

Examples

Suppose that the first axis is the X axis, and the second and subsequent axes are the Y, Z, A, B, and C axes in that order, and that they are controlled as follows:

X, Y, Z, and A axes: Controlled by the CNC

A axis: Controlled by the CNC and PMC

B and C axes: Controlled by the PMC

Then set this parameter to 4 (total 4: X, Y, Z, and A)

	#7	#6	#5	#4	#3	#2	#1	#0
1012								IDGx

[Data type] Bit axis

IDGx The function for setting the reference position again, without dogs, is:
0 : Not inhibited.
1 : Inhibited.

NOTE

- 1 IDGx is enabled when the IDG parameter (bit 7 of parameter No.1002) is 1.
- 2 When the function for setting the reference position, without dogs, is used, and the reference position is lost for some reason, an alarm requesting reference position return (No.300) is generated when the power is next turned on. If the operator performs reference position return, as a result of mistakenly identifying the alarm as that requesting the operator to perform a normal reference position return, an invalid reference position may be set. To prevent such an operator error, the IDGx parameter is provided to prevent the reference position from being set again without dogs.
 - (1) If the IDG parameter (bit 7 of parameter No.1002) is set to 1, the IDGx parameter (bit 0 of parameter No.1012) is automatically set to 1 when the reference position is set using the function for setting the reference position without dogs. This prevents the reference position from being set again without dogs.
 - (2) Once the reference position is prevented from being set for an axis again, without dogs, any attempt to set the reference position for the axis without dogs results in the output of an alarm (No.090).
 - (3) When the reference position must be set again without dogs, set IDGx to 0 before setting the reference position.

1020

Program axis name for each axis

[Data type] Byte axis

Set the program axis name for each controlled axis, using one of the values listed in the following table:

Axis name	Setting	Axis name	Setting	Axis name	Setting	Axis name	Setting
X	88	U	85	A	65	E	69
Y	89	V	86	B	66		
Z	90	W	87	C	67		

NOTE

- 1 With the T series, when G code system A is used, neither U, V, nor W can be used as an axis name. Only when G code system B or C is used, U, V, and W can be used as axis names.
- 2 The same axis name cannot be assigned to more than one axis.
- 3 When the secondary auxiliary function (option) is provided, the address used by the secondary auxiliary function (address B with the T series or, with the M series, the address specified in parameter No.3460) cannot be used as an axis name.
- 4 With the T series, when address C or A is used for chamfering, corner rounding, or direct drawing dimension programming (when the CCR parameter (bit 4 of parameter No.3405) is set to 1), addresses C or A cannot be used as an axis name.
- 5 Only with the T series, address E can be used as an axis name. Address E cannot be used with the M series. When address E is used as an axis name, note the following:
 - When G code system A is used, address E is always assigned to an absolute command.
 - When an equal-lead threading command (G32) is issued in the Series 15 command format, address E cannot be used to specify the thread lead. Use address F to specify the thread lead.

1022

Setting of each axis in the basic coordinate system

NOTE

When this parameter is set, power must be turned off before operation is continued.

[Data type] Byte axis

To determine the following planes used for circular interpolation, cutter compensation C (for the M series), tool nose radius compensation (for the T series), etc., each control axis is set to one of the basic three axes X, Y, and Z, or an axis parallel to the X, Y, or Z axis.

G17: Plane Xp–Yp

G18: Plane Zp–Xp

G19: Plane Yp–Zp

Only one axis can be set for each of the three basic axes X, Y, and Z, but two or more parallel axes can be set.

Set value	Meaning
0	Neither the basic three axes nor a parallel axis
1	X axis of the basic three axes
2	Y axis of the basic three axes
3	Z axis of the basic three axes
5	Axis parallel to the X axis
6	Axis parallel to the Y axis
7	Axis parallel to the Z axis

1023

Number of the servo axis for each axis

NOTE

When this parameter is set, power must be turned off before operation is continued.

[Data type] Byte axis

[Valid data range] 1, 2, 3, ..., number of control axes /-1,-2,-3,-4 (only for 16i)

Set the servo axis for each control axis.

Usually set to same number as the control axis number.

The control axis number is the order number that is used for setting the axis-type parameters or axis-type machine signals

To use a controlled axis as a spindle, specify -1.

Setting parameter CSS (bit 7 of parameter No. 3704) to 1 enables the second to fourth serial spindles to be assigned as Cs contour axes.

Refer to FSSB section of CONNECTION MANUAL (Function) B-63003EN-1.

4.13 PARAMETERS OF COORDINATES

	#7	#6	#5	#4	#3	#2	#1	#0
1201	WZR		AWK		FPC	ZCL	ZPI	ZPR
			AWK		FPC	ZCL	ZPI	ZPR

[Data type] Bit

ZPR Automatic setting of a coordinate system when the manual reference position return is performed
 0 : Not set automatically
 1 : Set automatically

NOTE

- 1 ZPR is valid while a workpiece coordinate system function is not provided. If a workpiece coordinate system function is provided, making a manual reference position return always causes the workpiece coordinate system to be established on the basis of the workpiece origin offset (parameters No. 1220 to No. 1226), irrespective of this parameter setting.
- 2 If an absolute-position coder is used in a system not using a workpiece coordinate system function, set this parameter.

ZPI Coordinates at the reference position when a coordinate system is set automatically
 0 : Value set in parameter No.1250 is used.
 1 : For input in mm, the value set in parameter 1250 is used, or for input in inches, the value set in parameter No.1251 is used.

This bit is ineffective, when a workpiece coordinate system option is provided, however.

ZCL Local coordinate system when the manual reference position return is performed
 0 : The local coordinate system is not canceled.
 1 : The local coordinate system is canceled.

FPC When the floating reference position is specified using soft keys on the current position display screen
 0 : The value of the displayed relative position is not preset. (In other words, the value does not change.)
 1 : The value of the displayed relative position is preset to 0.

AWK When the workpiece zero point offset value is changed
 0 : The absolute position display changed when the next buffering block is performed.
 1 : The absolute position display is changed immediately.
 Changed value is valid after buffering the next block.

WZR Upon reset, the workpiece coordinate system is:
 0 : Not returned to that specified with G54
 1 : Returned to that specified with G54

NOTE

If bit 2 (D3R) of parameter No. 5400 is set to 1, this parameter setting is ignored in the three-dimensional coordinate conversion mode. A reset does not cause the workpiece coordinate system to be returned to that specified with G54.

	#7	#6	#5	#4	#3	#2	#1	#0
1202					RLC	G50	EWS	EWD
			G52	RLC				

[Data type] Bit

- EWD** The shift direction of the workpiece coordinate system is:
 0 : The direction specified by the external workpiece zero point offset value
 1 : In the opposite direction to that specified by the external workpiece zero point offset value

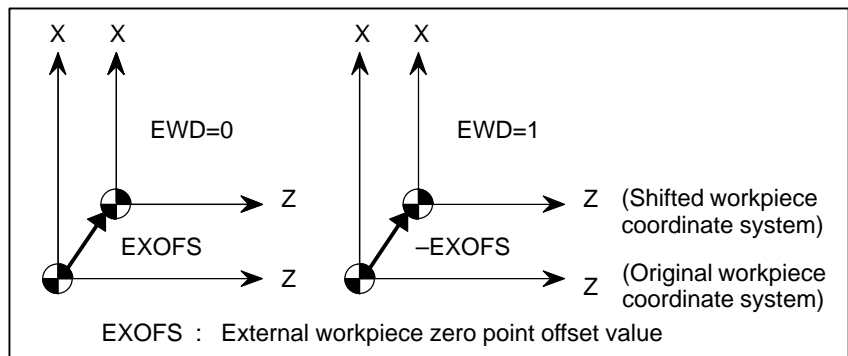

- EWS** Shift value of the workpiece coordinate system and external workpiece zero point offset value are
 0 : Stored in the separate memory areas.
 1 : Stored in the same memory area, that is, the shift and the offset values are the same.

- G50** When the CNC has commands G54 to G59 specifying workpiece coordinate systems (optional function), if the G50 command for setting a coordinate system (or the G92 command in G command system B or C) is specified,
 0 : G50 is executed and no alarm is issued.
 1 : G50 is not executed and a P/S alarm (No. 010) is issued.

- RLC** Local coordinate system is
 0 : Not cancelled by reset
 1 : Cancelled by reset

- G52** In local coordinate system setting (G52), a cutter compensation vector is:
 0 : Not considered.
 1 : Considered.

NOTE

Select a local coordinate system setting operation when cutter compensation is applied, and when two or more blocks specifying no movement exist prior to the specification of G52, or when G52 is specified after cutter compensation mode is canceled without eliminating the offset vector.

1220

External workpiece zero point offset value

[Data type] 2-word axis

[Unit of data]

Input increment	IS-A	IS-B	IS-C	Unit
Linear axis (input in mm)	0.01	0.001	0.0001	mm
Linear axis (input in inches)	0.001	0.0001	0.00001	inch
Rotation axis	0.01	0.001	0.0001	deg

[Valid data range] -99999999 to 99999999

This is one of the parameters that give the position of the origin of workpiece coordinate system (G54 to G59). It gives an offset of the workpiece origin common to all workpiece coordinate systems. In general, the offset varies depending on the workpiece coordinate systems. The value can be set from the PMC using the external data input function.

1221

Workpiece zero point offset value in workpiece coordinate system 1 (G54)

1222

Workpiece zero point offset value in workpiece coordinate system 2(G55)

1223

Workpiece zero point offset value in workpiece coordinate system 3(G56)

1224

Workpiece zero point offset value in workpiece coordinate system 4 (G57)

1225

Workpiece zero point offset value in workpiece coordinate system 5 (G58)

1226

Workpiece zero point offset value in workpiece coordinate system 6 (G59)

[Data type] 2-word axis

[Unit of data]

Input increment	IS-A	IS-B	IS-C	Unit
Linear axis (input in mm)	0.01	0.001	0.0001	mm
Linear axis (input in inches)	0.001	0.0001	0.00001	inch
Rotation axis	0.01	0.001	0.0001	deg

[Valid data range] -99999999 to 99999999

The workpiece zero point offset values in workpiece coordinate systems 1 to 6 (G54 to G59) are set.

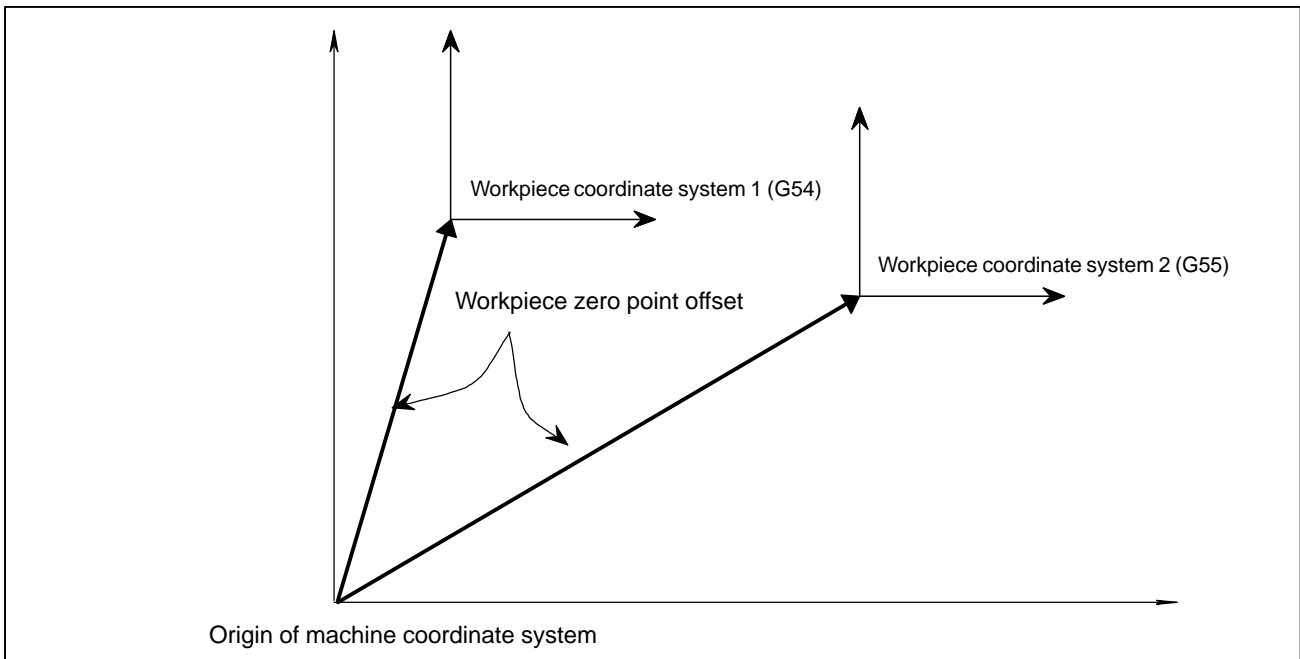

NOTE

The workpiece origin offset can also be set using the workpiece coordinate system screen.

1240

Coordinate value of the reference position on each axis in the machine coordinate system

NOTE

When this parameter is set, power must be turned off before operation is continued.

1241

Coordinate value of the second reference position on each axis in the machine coordinate system

1242

Coordinate value of the third reference position on each axis in the machine coordinate system

1243

Coordinate value of the fourth reference position on each axis in the machine coordinate system

[Data type] 2-word axis

[Unit of data]

Increment system	IS-A	IS-B	IS-C	Unit
Millimeter machine	0.01	0.001	0.0001	mm
Inch machine	0.001	0.0001	0.00001	inch
Rotation axis	0.01	0.001	0.0001	deg

[Valid data range] -99999999 to 99999999

Set the coordinate values of the first to fourth reference positions in the machine coordinate system.

1244

Coordinates of the floating reference position for each axis

[Data type] 2-word axis**[Unit of data]**

Increment system	IS-A	IS-B	IS-C	Unit
Millimeter machine	0.01	0.001	0.0001	mm
Inch input	0.001	0.0001	0.00001	inch
Rotation axis	0.01	0.001	0.0001	deg

[Valid data range] -99999999 to 99999999

This parameter specifies the coordinates of the floating reference position for each axis. The parameter is automatically set when the floating reference position is specified using soft keys on the current position display screen.

1250

Coordinate value of the reference position used when automatic coordinate system setting is performed

[Data type] 2-word axis**[Unit of data]**

Input increment	IS-A	IS-B	IS-C	Unit
Linear axis (input in mm)	0.01	0.001	0.0001	mm
Linear axis (input in inches)	0.001	0.0001	0.00001	inch
Rotation axis	0.01	0.001	0.0001	deg

[Valid data range] -99999999 to 99999999

Set the coordinate value of the reference position on each axis to be used for setting a coordinate system automatically.

1251

Coordinate value of the reference position on each axis used for setting a coordinate system automatically when input is performed in inches

[Data type] 2-word axis**[Unit of data]**

Increment system	IS-A	IS-B	IS-C	Unit
Linear axis (input in inches)	0.001	0.0001	0.00001	inch

[Valid data range] -99999999 to 99999999

Set the coordinate value of the reference position on each axis to be used for setting a coordinate system automatically when input is performed in inches.

NOTE

This parameter is valid when ZPI in parameter 1201 is set to 1.

1260	Amount of a shift per one rotation of a rotation axis
------	---

NOTE
 When this parameter is set, the power must be turned off before operation is continued.

[Data type] 2-word axis

[Unit of data]

Increment system	Unit of data	Standard value
IS-A	0.01 deg	36000
IS-B	0.001 deg	360000
IS-C	0.0001 deg	3600000

[Valid data range] 1000 to 9999999

Set the amount of a shift per one rotation of a rotation axis.

1280	First address of the signal group used by the external machine zero point shift extension
------	---

[Data type] Word

[Valid data range] 0 to 65535

Set the first address of the signal group used by the external machine zero point shift extension. If 100 is specified, R0100 to R0115 can be used.

R0100	Shift amount of external machine zero point shift extension for the first axis (LOW)
R0101	Shift amount of external machine zero point shift extension for the first axis (HIGH)
R0102	Shift amount of external machine zero point shift extension for the second axis (LOW)
R0103	Shift amount of external machine zero point shift extension for the second axis (HIGH)
:	:
:	:
:	:
:	:
R0114	Shift amount of external machine zero point shift extension for the eighth axis (LOW)
R0115	Shift amount of external machine zero point shift extension for the eighth axis (HIGH)

NOTE

- 1 If the specified number is not present, the external machine zero point shift extension is disabled.
- 2 A shift amount of the external machine zero point shift extension can be written from the C executer or macro executer.

1290	Distance between two opposite tool posts in mirror image
------	--

[Data type] 2-word

[Unit of data]

Increment system	IS-A	IS-B	IS-C	Unit
Millimeter machine	0.01	0.001	0.0001	mm
Inch machine	0.001	0.0001	0.00001	inch

[Valid data range] 0 to 99999999

Set the distance between two opposite tool posts in mirror image.

4.14 PARAMETERS OF STROKE CHECK

	#7	#6	#5	#4	#3	#2	#1	#0
1300	BFA	LZR	RL3			LMS		OUT

[Data type] Bit

OUT The area inside or outside of the stored stroke check 2 is set as an inhibition area (setting by the parameters No.1322 and No.1323).

- 0: Inside
- 1: Outside

LMS The EXLM signal for switching stored stroke check

- 0: Disabled
- 1: Enabled

NOTE

Stored stroke check 1 supports two pairs of parameters for setting the prohibited area. The stored stroke limit switching signal is used to enable either of the prohibited areas set with these parameter pairs.

- (1) Prohibited area I: Parameters No.1320 and No.1321
- (2) Prohibited area II: Parameters No.1326 and No.1327

RL3 Stored stroke check 3 release signal RLSOT3 is

- 0: Disabled
- 1: Enabled

LZR Checking of stored stroke check 1 during the time from power-on to the manual position reference return

- 0: The stroke check 1 is checked.
- 1: The stroke check 1 is not checked

NOTE

When an absolute position detector is used and a reference position is already set upon power-up, stored stroke limit check 1 is started immediately after power-up, regardless of the setting.

BFA When a command that exceeds a stored stroke check is issued

- 0: An alarm is generated after the stroke check is exceeded.
- 1: An alarm is generated before the stroke check is exceeded.

NOTE

The tool stops at a point up to F/7500 mm short of or ahead of the boundary.
(F: Feedrate when the tool reaches the boundary (mm/min))

	#7	#6	#5	#4	#3	#2	#1	#0
1301	PLC			OF1	OTA	NPC		DLM
	PLC		OTS	OF1	OTA	NPC		DLM

[Data type] Bit

DLM The stored stroke limit switching signal for each axial direction is:

- 0: Enabled.
- 1: Disabled.

NPC As part of the stroke limit check performed before movement, the movement specified in G31 (skip) and G37 (automatic tool length measurement (for M series) or automatic tool compensation (for T series)) blocks is:

- 0: Checked
- 1: Not checked

OTA If the tool is already in the prohibited area at power-up (or when the conditions of interference check are satisfied), an alarm of stored stroke limit 2 (inside), stored stroke limit 3, or interference check is:

- 0: Not raised before a movement is made. (No movement can be made in an interference check of T series.)
- 1: Immediately raised.

Remark) When the alarm is immediately raised, the system enters the state before power-down.

If this parameter is set to 1, no alarm is raised before a movement is made. If the direction of this movement is a direction away from the prohibited area, movements can be made in the opposite direction only. Accordingly, there is danger that the tool enters the prohibited area without an alarm.

OF1 If the tool is moved into the range allowed on the axis after an alarm is raised by stored stroke check 1,

- 0: The alarm is not canceled before a reset is made.
- 1: The OT alarm is immediately canceled.

OTS If a stored stroke limit alarm is raised by setting bit 7 (BFA) of parameter No. 1300 to 1, the axial movement stops:

- 0: Before the boundary of stored stroke check.
- 1: On the boundary of stored stroke check.

NOTE

To enable this parameter, the manual linear/circular interpolation function is required. If this function is not provided, this parameter setting is ignored.

PLC Stroke limit check before movement is:

- 0: Not performed
- 1: Performed

	#7	#6	#5	#4	#3	#2	#1	#0
1310							OT3x	OT2x
							OT3x	OT2x

[Data type] Bit axis

OT2x Whether stored stroke check 2 is checked for each axis is set.
 0: Stored stroke check 2 is not checked.
 1: Stored stroke check 2 is checked.

OT3x Whether stored stroke check 3 is checked for each axis is set.
 0: Stored stroke check 3 is not checked.
 1: Stored stroke check 3 is checked.

1320	Coordinate value l of stored stroke check 1 in the positive direction on each axis
------	--

1321	Coordinate value l of stored stroke check 1 in the negative direction on each axis
------	--

[Data type] 2-word axis

[Unit of data]

Increment system	IS-A	IS-B	IS-C	Unit
Millimeter machine	0.01	0.001	0.0001	mm
Inch machine	0.001	0.0001	0.00001	inch
Rotation axis	0.01	0.001	0.0001	deg

[Valid data range] -99999999 to 99999999

The coordinate values of stored stroke check 1 in the positive and negative directions are set for each axis in the machine coordinate system. The outside area of the two checks set in the parameters is inhibited.

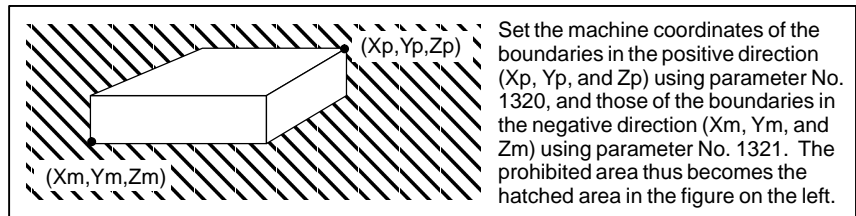

NOTE

- 1 For axes with diameter specification, a diameter value must be set.
- 2 When the parameters are set as follows, the stroke becomes infinite:
 parameter 1320 < parameter 1321
 For movement along the axis for which infinite stroke is set, only increment commands are available. (The stored stroke limit switching signal also becomes invalid.) If an absolute command is issued for this axis, the absolute register may overflow, and normal movement will not result.
- 3 The prohibited area specified with these parameters is invalid if bit 2 (LMS) of parameter No. 1300 is set to 1 and stored stroke limit switching signal EXLM is set to 1. In such a case, the settings of parameters No. 1326 and 1327 are used, instead.

1322	Coordinate value of stored stroke check 2 in the positive direction on each axis
1323	Coordinate value of stored stroke check 2 in the negative direction on each axis

[Data type] 2-word axis

[Unit of data]

Increment system	IS-A	IS-B	IS-C	Unit
Millimeter machine	0.01	0.001	0.0001	mm
Inch machine	0.001	0.0001	0.00001	inch
Rotation axis	0.01	0.001	0.0001	deg

[Valid data range] -99999999 to 99999999

Set the coordinate values of stored stroke check 2 in the positive and negative directions for each axis in the machine coordinate system. OUT, #0 of parameter 1300, sets either the area outside of the area inside specified by two checks are the inhibition area.

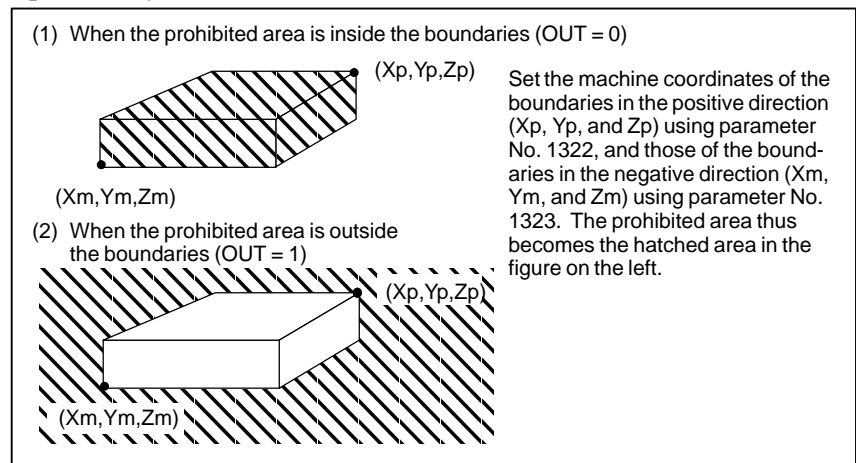

NOTE

For axes with diameter specification, a diameter value must be set.

1324	Coordinate value of stored stroke check 3 in the positive direction on each axis
1325	Coordinate value of stored stroke check 3 in the negative direction on each axis

[Data type] 2-word axis

[Unit of data]

Increment system	IS-A	IS-B	IS-C	Unit
Millimeter machine	0.01	0.001	0.0001	mm
Inch machine	0.001	0.0001	0.00001	inch
Rotation axis	0.01	0.001	0.0001	deg

[Valid data range] -99999999 to 99999999

Set the coordinate values of stored stroke check 3 in the positive and negative directions for each axis in the machine coordinate system. The area inside the checks set in the parameter is inhibited.

NOTE

Specify diameters for any axis for which diameter programming is specified.

1326	Coordinate value II of stored stroke check 1 in the positive direction on each axis
1327	Coordinate value II of stored stroke check 1 in the negative direction on each axis

[Data type] 2-word axis

[Unit of data]

Increment system	IS-A	IS-B	IS-C	Unit
Millimeter machine	0.01	0.001	0.0001	mm
Inch machine	0.001	0.0001	0.00001	inch
Rotation axis	0.01	0.001	0.0001	deg

[Valid data range] -99999999 to 99999999

Set the coordinate values of stored stroke check 1 in the positive and negative directions for each axis in the machine coordinate system.

When stroke check switching signal EXLM is ON, stroke check are checked with parameters 1326 and 1327, not with parameters 1320 and 1321. The area outside that set by parameters 1326 and 1327 is inhibited.

NOTE

- 1 Specify diameter values for any axes for which diameter programming is specified.
- 2 These parameters are invalid if bit 2 (LMS) of parameter No. 1300 is set to 0, or if stored stroke limit switching signal EXLM is set to 0. In such a case, the settings of parameters No. 1320 and 1321 are used, instead.

4.15 PARAMETERS OF THE CHUCK AND TAILSTOCK BARRIER (T SERIES)

1330	Profile of a chuck
------	--------------------

[Data type] Byte

[Valid data range] 0 or 1

0: Chuck which holds a workpiece on the inner surface

1: Chuck which holds a workpiece on the outer surface

1331	Dimensions of the claw of a chuck (L)
------	---------------------------------------

1332	Dimensions of the claw of a chuck (W)
------	---------------------------------------

1333	Dimensions of the part of a claw at which a workpiece is held (L1)
------	--

1334	Dimensions of the part of a claw at which a workpiece is held (W1)
------	--

1335	X coordinate of a chuck (CX)
------	------------------------------

1336	ZX coordinate of a chuck (CZ)
------	-------------------------------

[Data type] 2-word

[Unit of data]

Increment system	IS-B	IS-C	Unit
Millimeter input	0.001	0.0001	mm
Inch input	0.0001	0.00001	inch

[Valid range] No.1331 to No.1334: 0 to 99999999

No.1335 to No.1336: -99999999 to 99999999

Specify the profile of a chuck.

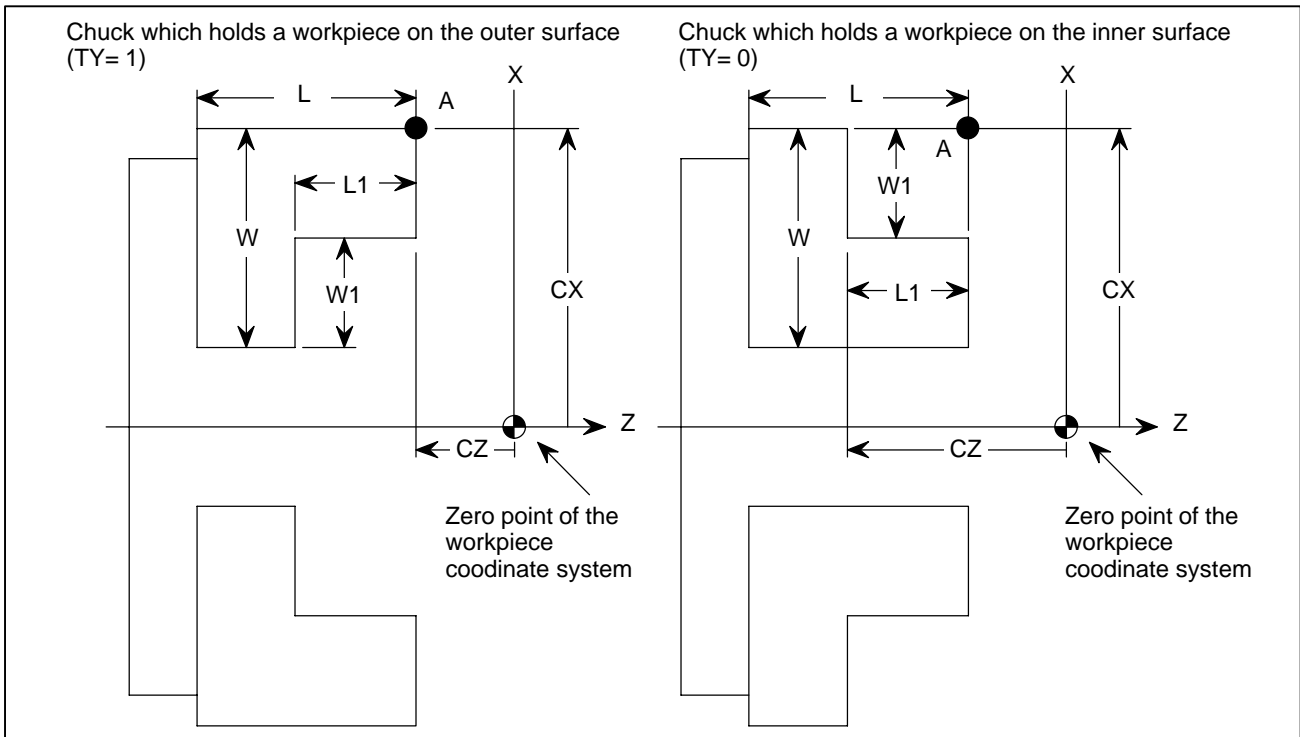

Symbol	Description
Ty	Profile of a chuck (0: Chuck which holds a workpiece on the inner surface, 1: Chuck which holds a workpiece on the outer surface)
CX	X coordinate of a chuck
CZ	Z coordinate of a chuck
L	Dimensions of the claw of a chuck
W	Dimensions of the claw of a chuck (radius input)
L ₁	Dimensions of the part of a claw at which a workpiece is held
W ₁	Dimensions of the part of a claw at which a workpiece is held (radius input)

TY Specifies the profile of a chuck. When TY is set to 0, the chuck holding a workpiece on the inner surface is specified. When TY is set to 1, the chuck holding a workpiece on the outer surface is specified. The profile of the chuck is assumed to be symmetrical with respect to the z-axis.

CX, and CZ Specify the position (point A) of a chuck with the coordinates of the workpiece coordinate system. In this case, do not use the coordinates of the machine coordinate system.

NOTE

Specifying the coordinates with a diameter or radius depends on whether the corresponding axis conforms to diameter or radius specification. When the axis conforms to diameter specification, specify the coordinates with a diameter.

L, L1, W and W1 Define the profile of a chuck.

NOTE

Always specify W and W1 with radii. Specify L and L1 with radii when the Z-axis conforms to radius specification.

1341	Length of a tailstock (L)
1342	Diameter of a tailstock (D)
1343	Length of a tailstock (L1)
1344	Diameter of a tailstock (D1)
1345	Length of a tailstock (D1)
1346	Diameter of a tailstock (D2)
1347	Diameter of the hole of a tailstock (D3)
1348	Z coordinate of a tailstock (TZ)

[Data type] 2-words

[Unit of data]

Increment system	IS-B	IS-C	Unit
Millimeter input	0.001	0.0001	mm
Inch input	0.0001	0.00001	inch

[Valid range] No.1341 to No.1347: 0 to 99999999
 No.1348: -99999999 to 99999999

Specify the profile of a tailstock.

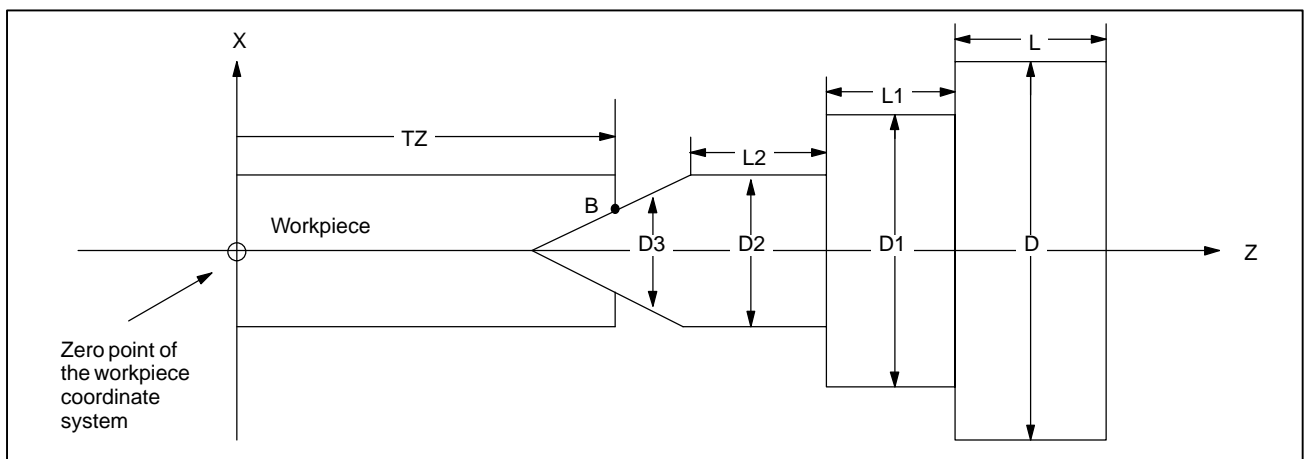

Symbol	Description
TZ	Z-axis coordinate of a tailstock
L	Length of a tailstock
D	Diameter of a tailstock (diameter input)
L1	Length of a tailstock (1)
D1	Diameter of a tailstock (1) (diameter input)
L2	Length of a tailstock (2)
D2	Diameter of a tailstock (2) (diameter input)
D3	Diameter of the hole of a tailstock (diameter input)

TZ: Specifies the position (point B) of a tailstock with the Z-axis coordinate of the workpiece coordinate system. In this case, do not use the coordinate of the machine coordinate system. The profile of a tailstock is assumed to be symmetrical with respect to the Z-axis.

NOTE

Specifying the position of a tailstock with a radius or diameter depends on whether the Z-axis conforms to radius or diameter specification.

L, L1, L2, D, D1, D2, and D3:

Define the profile of a tailstock.

NOTE

Always specify D, D1, D2, and D3 with diameters. Specify L, L1, and L2 with radiuses if the Z-axis conforms to radius specification.

4.16 PARAMETERS OF FEEDRATE

	#7	#6	#5	#4	#3	#2	#1	#0
1401		RDR	TDR	RF0		JZR	LRP	RPD
		RDR	TDR	RF0			LRP	RPD

[Data type] Bit

- RPD** Manual rapid traverse during the period from power-on time to the completion of the reference position return.
0: Disabled (Jog feed is performed.)
1: Enabled
- LRP** Positioning (G00)
0: Positioning is performed with non-linear type positioning so that the tool moves along each axis independently at rapid traverse.
1: Positioning is performed with linear interpolation so that the tool moves in a straight line.
- JZR** The manual reference position return at JOG feedrate
0: Not performed
1: Performed
- RF0** When cutting feedrate override is 0% during rapid traverse,
0: The machine tool does not stop moving.
1: The machine tool stops moving.
- TDR** Dry run during threading or tapping (tapping cycle G74 or G84, rigid tapping)
0: Enabled
1: Disabled
- RDR** Dry run for rapid traverse command
0: Disabled
1: Enabled

	#7	#6	#5	#4	#3	#2	#1	#0
1402				JRV	OV2		JOV	NPC
					OV2		JOV	NPC

[Data type] Bit

- NPC** The feed per rotation command is:
0: Ineffective when a position coder is not provided.
1: Effective even when a position coder is not provided (because the CNC converts it to the feed per minute command from F command S command).

NOTE

To use a position coder, set this parameter to 0. While this parameter is set to 1, threading cannot be performed even if a position coder is provided.

- JOV** Job override is:
0: Enabled
1: Disabled (tied to 100%)

- OV2** 2nd feedrate override is
 0: specified every 1%
 1: specified every 0.01%

NOTE
 Signals used for 2nd feedrate override are:
 *AFV0 to AFV7 <G013> when OV2 = 0
 *APF00 to *AFP15 <G094, G095> when OV2 = 1

- JRV** Manual continuous feed (jog feed)
 0: Jog feed is performed at feed per minute.
 1: Jog feed is performed at feed per rotation.

NOTE
 Specify a feedrate in parameter No.1423.

	#7	#6	#5	#4	#3	#2	#1	#0
1403	RTV							MIF

NOTE
 When this parameter is set, the power must be turned off before operation is continued.

[Data type] Bit

- MIF** Cutting feedrates at feed per minute is specified by F commands
 0: In units of 1 mm/min for millimeter machines or 0.01 inches/min for inch machines.
 1: In unit of 0.001 mm/min for millimeter machines or 0.00001 inches/min for inch machines.

NOTE
 M series are not equipped with this parameter. Cutting feedrates are specified by F commands in units of 0.001 mm/min for millimeter machines or 0.00001 inches/min for inch machines.

- RTV** Override while the tool is retracting in threading
 0 : Override is effective.
 1 : Override is not effective.

	#7	#6	#5	#4	#3	#2	#1	#0
1404			EDR		FRV	F8A	DLF	HFC

[Data type] Bit

- HFC** The feedrate for helical interpolation is:
 0: Clamped so that the feedrates along an arc and linear axis do not exceed the maximum cutting feedrate specified by parameter (No.1422 or 1430).
 1: Clamped so that the composite feedrate along an arc and linear axis does not exceed the maximum cutting feedrate specified by parameter (No.1422).

DLF After a reference position is set, manual reference position return performed at:

0 : Rapid traverse rate (parameter No.1420)

1 : Manual rapid traverse rate (parameter No.1424)

NOTE

This parameter selects a feedrate for reference position return performed without dogs. This parameter also selects a feedrate when manual reference position return is performed according to bit 7 (SJZ) of parameter No.0002 using rapid traverse without deceleration dogs after a reference position is set.

<For T series>

F8A Valid data range for an F command in feed-per-minute mode

0: Range specified with bit 0 (MIF) of parameter No.1403

1:	Increment system	Units	IS-A, IS-B	IS-C
	Millimeter input	mm/min	0.001 to 240000.	0.001 to 100000.
	Inch input	inch/min	0.00001 to 9600.	0.00001 to 4000.
	Rotation axis	deg/min	1 to 240000.	1 to 100000.

<For M series>

F8A Valid data range for an F command with a decimal point in feed-per-minute mode

0:	Increment system	Units	IS-A, IS-B	IS-C
	Millimeter input	mm/min	0.001 to 99999.999.	
	Inch input	inch/min	0.00001 to 999.99999.	
	Rotation axis (mm)	deg/min	1 to 240000.	1 to 100000.
	Rotation axis (inch)	deg/min	1 to 9600.	1 to 4000.

1:	Increment system	Units	IS-A, IS-B	IS-C
	Millimeter input	mm/min	0.001 to 240000.	0.001 to 100000.
	Inch input	inch/min	0.00001 to 9600.	0.00001 to 4000.
	Rotation axis	deg/min	1 to 240000.	1 to 100000.

FRV For inch input, the valid range of the feedrate specified for feed per revolution is:

0 : Standard range. (F0.000001 to 9.999999 inches per revolution)

1 : Extended to F50.0 inches per revolution. (F0.000001 to 50.000000 inches per revolution)

EDR The external deceleration speed in liner interpolation type positioning is set in:

0: Parameter No. 1426.

1: Parameter No. 1427, for the first axis.

	#7	#6	#5	#4	#3	#2	#1	#0
1405						PCL		
							FD3	F1U

[Data type] Bit

F1U Specifies the units of the data for the parameters that set the feedrates of the F1-digit feed commands (parameter Nos. 1451 to 1459).

Increment system	Units of data	
	When F1U is 0	When F1U is 1
Millimeter machine	0.1 mm/min	1 mm/min
Inch machine	0.001 inch/min	0.1 inch/min
Rotation axis	0.1 deg/min	1 deg/min

FD3 The number of significant digits of the fractional part in the feedrate command (F command) for feed per revolution is:

- 0 : Up to two decimal positions (three decimal positions for inch input).
- 1 : Up to three decimal positions (four decimal positions for inch input).

PCL The function for feed per rotation without the position coder is:

- 0 : Not used.
- 1 : Used.

NOTE

The option for constant surface speed control without the position coder is required.
To set this parameter to 1, set bit 0 (NPC) of parameter No. 1402 to 0.

	#7	#6	#5	#4	#3	#2	#1	#0
1408								RFD

[Data type] Bit axis type

RFD The feedrate about a rotation axis is controlled:

- 0: In the usual method.
- 1: By converting the rotation speed about the rotation axis into the travel speed on the circumference of a virtual circle.

Set the radius of the virtual circle in parameter No. 1465.

1410	Dry run rate
------	--------------

[Data type] Word

[Unit of data]

[Valid data range]

Increment system	Unit of data	Valid data range	
		IS-A, IS-B	IS-C
Millimeter machine	1 mm/min	6 to 15000	6 to 12000
Inch machine	0.1 inch/min	6 to 6000	6 to 4800

Set the dry run rate when the manual feedrate is overridden by 100%. Specify the jog feedrate when the override is 100% for manual linear or circular interpolation.

1411	
	Cutting feedrate in the automatic mode at power-on

Setting entry is acceptable.

[Data type] Word

[Unit of data]

[Valid data range]

Increment system	Unit of data	Valid data range	
		IS-A, IS-B	IS-C
Millimeter machine	1 mm/min	6 to 32767	6 to 32767
Inch machine	0.1 inch/min	6 to 32767	6 to 32767

When the machine requires little change in cutting feedrate during cutting, a cutting feedrate can be specified in the parameter. This eliminates the need to specify a cutting feedrate (F command) in the NC program.

The cutting feedrate set by this parameter is valid after the CNC is placed in the clear state by power-up or a reset until a feedrate is specified by a program command (F command). After a feedrate is specified by the F command, the feedrate becomes valid.

1414	
	Feedrate for retrace

[Data type] 2-word

This parameter sets the feedrate for retrace when the retrace function is used.

(1) For rapid traverse

[Unit of data]

[Valid data range]

Increment system	Unit of data	Valid data range	
		IS-A, IS-B	IS-C
Millimeter machine	1 mm/min	6 to 240000	6 to 100000
Inch machine	0.1 inch/min	6 to 96000	6 to 48000
Rotation axis	1 deg/min	6 to 240000	6 to 100000

NOTE

When 0 is set in this parameter, the rapid traverse rate that is set in parameter No.1420 is used for retrace.

(2) For cutting feed

When a value other than 0 is specified in this parameter, the same feedrate as an F command specified using the value without a decimal point is set and is used for retrace. When 0 is specified in this parameter, the programmed feedrate (F command) is used for retrace.

1420

Rapid traverse rate for each axis

[Data type] 2-word axis**[Unit of data]****[Valid data range]**

Increment system	Unit of data	Valid data range	
		IS-A, IS-B	IS-C
Millimeter machine	1 mm/min	30 to 240000	6 to 100000
Inch machine	0.1 inch/min	30 to 96000	6 to 48000
Rotation axis	1 deg/min	30 to 240000	6 to 100000

Set the rapid traverse rate when the rapid traverse override is 100% for each axis.

1421

F0 rate of rapid traverse override for each axis

[Data type] Word axis**[Unit of data]****[Valid data range]**

Increment system	Unit of data	Valid data range	
		IS-A, IS-B	IS-C
Millimeter machine	1 mm/min	30 to 15000	30 to 12000
Inch machine	0.1 inch/min	30 to 6000	30 to 4800
Rotation axis	1 deg/min	30 to 15000	30 to 12000

Set the F0 rate of the rapid traverse override for each axis.

Rapid traverse override signal		Override value
ROV2	ROV1	
0	0	100%
0	1	50%
1	0	25%
1	1	F0

F0: Parameter 1421

1422

Maximum cutting feedrate for all axes

[Data type] 2-word**[Unit of data]****[Valid data range]**

Increment system	Unit of data	Valid data range	
		IS-A, IS-B	IS-C
Millimeter machine	1 mm/min	6 to 240000	6 to 100000
Inch machine	0.1 inch/min	6 to 96000	6 to 48000

Specify the maximum cutting feedrate.

A feedrate in the tangential direction is clamped in cutting feed so that it does not exceed the feedrate specified in this parameter.

NOTE

To specify the maximum cutting feedrate for each axis, use parameter No.1430 instead. (M series)

1423

Feedrate in manual continuous feed (jog feed) for each axis

[Data type] Word axis

- (1) In M series, or in T series when JRV, bit 4 of parameter No.1402, is set to 0 (feed per minute), specify a jog feedrate at feed per minute with an override of 100%.

[Unit of data, valid range]

Increment system	Unit of data	Valid data range	
		IS-A, IS-B	IS-C
Millimeter machine	1 mm/min	6 to 15000	6 to 12000
Inch machine	0.1 inch/min	6 to 6000	6 to 4800
Rotation axis	1 deg/min	6 to 15000	6 to 12000

- (2) When JRV, bit 4 of parameter No.1402, is set to 1 (feed per revolution) in T series, specify a jog feedrate (feed per revolution) under an override of 100%.

[Unit of data, valid range]

Increment system	Unit of data	Valid data range
Millimeter machine	0.01 mm/rev	0 to 32767
Inch machine	0.001 mm/rev	
Rotation axis	0.01 deg/rev	

1424

Manual rapid traverse rate for each axis

[Data type] 2-word axis**[Unit of data]****[Valid data range]**

Increment system	Unit of data	Valid data range	
		IS-A, IS-B	IS-C
Millimeter machine	1 mm/min	30 to 240000	30 to 100000
Inch machine	0.1 inch/min	30 to 96000	30 to 48000
Rotation axis	1 deg/min	30 to 240000	30 to 100000

Set the rate of manual rapid traverse when the rapid traverse override is 100% for each axis.

NOTE

If 0 is set, the rate set in parameter 1420 is assumed.

1425

FL rate of the reference position return for each axis

[Data type] Word axis**[Unit of data]****[Valid data range]**

Increment system	Unit of data	Valid data range	
		IS-A, IS-B	IS-C
Millimeter machine	1 mm/min	6 to 15000	6 to 12000
Inch machine	0.1 inch/min	6 to 6000	6 to 4800
Rotation axis	1 deg/min	6 to 15000	6 to 12000

Set feedrate (FL rate) after deceleration when the reference position return is performed for each axis.

1426

External deceleration rate of cutting feed

[Data type] Word axis**[Unit of data]****[Valid data range]**

Increment system	Unit of data	Valid data range	
		IS-A, IS-B	IS-C
Millimeter machine	1 mm/min	6 to 15000	6 to 12000
Inch machine	0.1 inch/min	6 to 6000	6 to 4800

Set the external deceleration rate of cutting feed.

1427

External deceleration rate of rapid traverse for each axis

[Data type] Word axis**[Unit of data]****[Valid data range]**

Increment system	Unit of data	Valid data range	
		IS-A, IS-B	IS-C
Millimeter machine	1 mm/min	6 to 15000	6 to 12000
Inch machine	0.1 inch/min	6 to 6000	6 to 4800
Rotation axis	1 deg/min	6 to 15000	6 to 12000

Set the external deceleration rate of rapid traverse for each axis.

1428

Reference position return feedrate

[Data type] 2-word axis**[Unit of data]****[Valid data range]**

Increment system	Unit of data	Valid data range	
		IS-A, IS-B	IS-C
Millimeter machine	1 mm/min	30 to 240000	6 to 100000
Inch machine	0.1 inch/min	30 to 96000	6 to 48000
Rotation axis	1 deg/min	30 to 240000	6 to 100000

This parameter sets a rapid traverse rate for reference position return operation using deceleration dogs, or for reference position return operation before a reference position is set.

This parameter is also used to set a feedrate for the rapid traverse command (G00) in automatic operation before a reference position is set.

NOTE

- 1 This parameter is invalid for an axis using the scale with absolute addressing reference marks.
- 2 When 0 is set in this parameter, this parameter disables the reference position return feedrate setting function.

		Before a reference position is set		After a reference position is set	
		No. 1428		No. 1428	
		=0	≠0	=0	≠0
Reference position return by G28		No.1420	No.1428	No.1420	
Raped traverse command (G00) in automatic operation				No.1420 or No.1424*3	
Manual reference position return	Without dogs*1	No.1424	No.1428	No.1424	No.1428
	With dogs*1				
Manual raped traverse		No.1423 or No.1424*2		No.1424	

- *1 With/without dogs: Reference position return operation not using/using deceleration dogs
- *2 For manual rapid traverse before a reference position is set, a jog feedrate (parameter No.1423) or manual raped traverse rate (parameter No.1424) is used according to the setting of bit 0 (RPD) of parameter No.1401.
- *3 The raped traverse rate set in parameter No.1424 or No.1420 is used according to the setting of bit 1 (DLF) of parameter No.1404 when reference position return is performed without dogs, or when reference position return operation is performed with bit 7 (SJZ) of parameter No.0002 set to 1 after a reference position is set (when reference position return operation is performed using rapid traverse without deceleration dogs).

1430	Maximum cutting feedrate for each axis
------	--

[Data type] 2-word axis

Increment system	Unit of data	Valid data range	
		IS-A, IS-B	IS-C
Millimeter machine	1 mm/min	6 to 240000	6 to 100000
Inch machine	0.1 inch/min	6 to 96000	6 to 48000
Rotation axis	1 deg/min	6 to 240000	6 to 100000

Specify the maximum cutting feedrate for each axis.

A feedrate for each axis is clamped in cutting feed so that it does not exceed the maximum feedrate specified for each axis.

NOTE

- 1 This parameter is effective only in linear and circular interpolation. In polar coordinate, cylindrical, and involute interpolation, the maximum feedrate for all axes specified in parameter No.1422 is effective.
- 2 If the setting for each axis is 0, the maximum feedrate specified in parameter No.1422 is applied to all axes and the feedrate is clamped at the maximum feedrate.

1431

Maximum cutting feedrate for all axes in the look-ahead control mode

[Data type] 2-words**[Unit of data, valid range]**

Increment system	Unit of data	Valid data range	
		IS-A, IS-B	IS-C
Millimeter machine	1 mm/min	0 to 240000	0 to 100000
Inch machine	0.1 inch/min	0 to 96000	0 to 48000
Rotation axis	1 deg/min	0 to 240000	0 to 100000

Specify the maximum cutting feedrate for all axes in the look-ahead control mode.

A feedrate in the tangential direction is clamped in cutting feed so that it does not exceed the feedrate specified in this parameter.

NOTE

- 1 To specify the maximum cutting feedrate for each axis, use parameter No.1432 instead.
- 2 In a mode other than the look-ahead mode, the maximum cutting feedrate specified in parameter No.1422 or No.1430 is applied and the feedrate is clamped at the maximum feedrate.

1432

Maximum cutting feedrate for each axis in the AI contour control mode or look-ahead control mode

[Data type] 2-word axis**[Unit of data, valid range]**

Increment system	Unit of data	Valid data range	
		IS-A, IS-B	IS-C
Millimeter machine	1 mm/min	0 to 240000	0 to 100000
Inch machine	0.1 inch/min	0 to 96000	0 to 48000
Rotation axis	1 deg/min	0 to 240000	0 to 100000

Specify the maximum cutting feedrate for each axis in the AI contour control mode or look-ahead control mode.

A feedrate for each axis is clamped during cutting feed so that it does not exceed the maximum cutting feedrate specified for each axis.

NOTE

- 1 This parameter is effective only in linear and circular interpolation. In polar coordinate, cylindrical, and involute interpolation, the maximum feedrate for all axes specified in parameter No.1431 is effective.
- 2 If a setting for each axis is 0, the maximum feedrate specified in parameter No.1431 is applied to all axes and the feedrate is clamped at the maximum feedrate.
- 3 In a mode other than the AI contour control mode or look-ahead mode, the maximum cutting feedrate specified in parameter No.1422 or No.1430 is applied and the feedrate is clamped at the maximum feedrate.
- 4 In the HPCC mode, if values are specified in both parameters No. 1430 and No. 1432, the setting of parameter No. 1432 takes priority. If nothing is specified in parameter No. 1430, the feedrate is clamped to the value specified in parameter No. 1422.

1450

Change of feedrate for one graduation on the manual pulse generator during F1 digit feed

[Data type] Byte**[Valid data range]** 1 to 127

Set the constant that determines the change in feedrate as the manual pulse generator is rotated one graduation during F1-digit feed.

$$\Delta F = \frac{F_{\max i}}{100n} \quad (\text{where, } i=1 \text{ or } 2)$$

In the above equation, set n. That is, the number of revolutions of the manual pulse generator, required to reach feedrate $F_{\max i}$ is obtained. $F_{\max i}$ refers to the upper limit of the feedrate for an F1-digit feed command, and set it in parameter 1460 or 1461.

$F_{\max 1}$: Upper limit of the feedrate for F1 to F4 (parameter 1460)

$F_{\max 2}$: Upper limit of the feedrate for F5 to F9 (parameter 1461)

1451	Feedrate for F1 digit command F1
1452	Feedrate for F1 digit command F2
1453	Feedrate for F1 digit command F3
1454	Feedrate for F1 digit command F4
1455	Feedrate for F1 digit command F5
1456	Feedrate for F1 digit command F6
1457	Feedrate for F1 digit command F7
1458	Feedrate for F1 digit command F8
1459	Feedrate for F1 digit command F9

Setting entry is acceptable.

[Data type] 2-word

[Unit of data, valid range]

(1) When the F1U parameter (bit 0 of parameter No.1405) is 0

Increment system	Units of data	Valid data range	
		IS-A, IS-B	IS-C
Millimeter machine	0.1 mm/min	6 to 150000	6 to 120000
Inch machine	0.01 inch/min	6 to 60000	6 to 48000
Rotation axis	0.1 deg/min	6 to 150000	6 to 120000

(2) When the F1U parameter (bit 0 of parameter No.1405) is 1

Increment system	Units of data	Valid data range	
		IS-A, IS-B	IS-C
Millimeter machine	1 mm/min	6 to 15000	6 to 12000
Inch machine	0.1 inch/min	6 to 6000	6 to 4800
Rotation axis	1 deg/min	6 to 15000	6 to 12000

These parameters set the feedrates for 1-digit feed commands F1 to F9.

When an 1-digit feed command is specified, and the feedrate is changed by turning the manual pulse generator, the parameter-set value also changes accordingly.

1460	
	Upper limit of feedrate for the one-digit F code command (F1 to F4)
1461	
	Upper limit of feedrate for the one-digit F code command (F5 to F9)

[Data type] 2-word

[Unit of data]

[Valid data range]

Increment system	Unit of data	Valid data range	
		IS-A, IS-B	IS-C
Millimeter machine	1 mm/min	6 to 15000	6 to 12000
Inch machine	0.1 inch/min	6 to 6000	6 to 4800
Rotation axis	1 deg/min	6 to 15000	6 to 12000

Set the upper limit of feedrate for the F1-digit feed command.

As the feedrate increases by turning the manual pulse generator, the feedrate is clamped when it reaches the upper limit set. If an F1-digit feed command F1 to F4 is executed, the upper limit is that set in parameter 1460. If an F1-digit command F5 to F9 is executed, the upper limit is that set in parameter 1461.

1465	
	Virtual radius for feedrate control about rotation axis

[Data type] 2-word

[Unit of data]

Increment system	IS-A	IS-B	IS-C	Unit
Metric input	0.01	0.001	0.0001	mm
Inch input				inch

[Valid data range] 0 to 99999999

4.17 PARAMETERS OF ACCELERATION/ DECELERATION CONTROL

	#7	#6	#5	#4	#3	#2	#1	#0
1601			NCI	RTO				
		ACD	NCI	RTO		OVB		

[Data type] Bit

OVB Block overlap in cutting feed
 0: Blocks are not overlapped in cutting feed.
 1: Blocks are overlapped in cutting feed.

Block overlap outputs the pulses remaining at the end of pulse distribution in a block together with distribution pulses in the next block. This eliminates changes in feedrates between blocks.

Block overlap is enabled when blocks containing G01, G02, or G03 are consecutively specified in G64 mode. If minute blocks, however, are specified consecutively, overlap may not be performed.

The following pulses in block F2 are added to the pulses remaining at the end of pulse distribution in block F1.

$$(\text{Number of pulses to be added}) = F2 \times \frac{(\text{Number of pulses required at the end of block F1})}{F1}$$

When F1 = F2

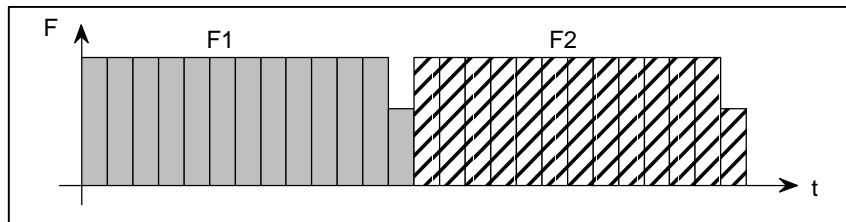

When block overlap is disabled

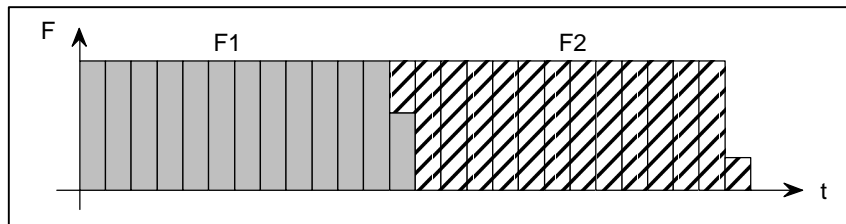

When block overlap is enabled

RTO Block overlap in rapid traverse
 0 : Blocks are not overlapped in rapid traverse.
 1 : Blocks are overlapped in rapid traverse.

NOTE
 See the description of parameter No.1722.

NCI Inposition check at deceleration
 0 : Performed
 1 : Not performed

ACD Function for automatically reducing the feedrate at corners (automatic corner override function)
 0 : The function is not used.
 1 : The function is used.

	#7	#6	#5	#4	#3	#2	#1	#0
1602						COV		
		LS2		CSD	BS2	COV		FWB

[Data type] Bit

FWB Cutting feed acceleration/deceleration before interpolation

0 : Type A of acceleration/deceleration before interpolation is used.

1 : Type B of acceleration/deceleration before interpolation is used.

Type A: When a feedrate is to be changed by a command, acceleration/deceleration starts after the program enters the block in which the command is specified.

Type B: When a feedrate is to be changed by a command, deceleration starts and terminates at the block before the block in which the command is specified.

When a feedrate is to be changed by a command, acceleration starts after the program enters the block in which the command is specified.

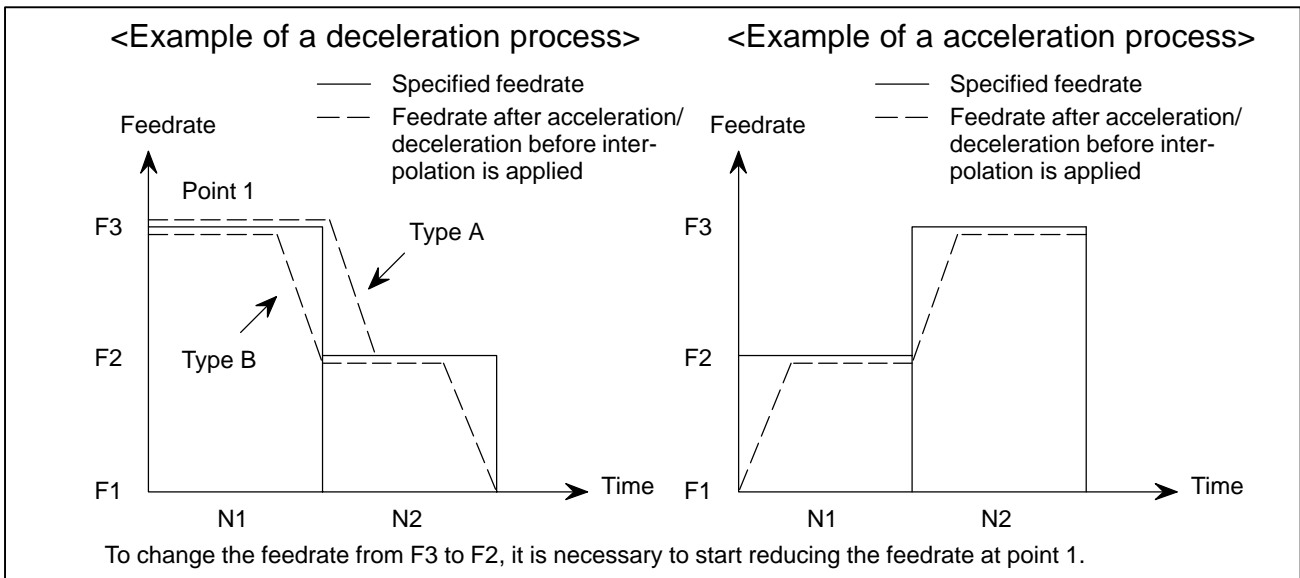

COV The outer arc cutting feedrate change function of the automatic corner override function is:

0 : Not used.

1 : Used.

BS2 Acceleration/deceleration after interpolation for cutting feed in look-ahead control mode/high-precision contour control mode is:

0 : Exponential acceleration/deceleration or linear acceleration/deceleration (one of which is selected by the LS2 parameter (bit 6 of parameter No.1602)).

1 : Bell-shaped acceleration/deceleration.

BS2	LS2	Acceleration/deceleration
0	0	Exponential acceleration/deceleration after interpolation
0	1	Linear acceleration/deceleration after interpolation. (The option for linear acceleration/deceleration after interpolation for cutting feed is required.)
1	0	Bell-shaped acceleration/deceleration after interpolation. (The option for bell-shaped acceleration/deceleration after interpolation for cutting feed is required.)

CSD In the function for automatically reducing a feedrate at corners,
 0 : Angles are used for controlling the feedrate.
 1 : Differences in feedrates are used for controlling the feedrate.

LS2 Acceleration/deceleration after interpolation for cutting feed in look-ahead control mode/high-precision contour control mode is:
 0 : Exponential acceleration/deceleration.
 1 : Linear acceleration/deceleration. (The function for linear acceleration/deceleration after interpolation for cutting feed is required.)

	#7	#6	#5	#4	#3	#2	#1	#0
1603				PRT				
	BEL	RBL		PRT	SBL			

[Data type] Bit

SBL In high-precision contour control by RISC, the bell-shaped acceleration/deceleration before interpolation is performed:
 0: With a constant acceleration change.
 1: With a constant acceleration time.

Set the time constant in parameter No. 8416.

PRT The acceleration/deceleration of interpolation-type rapid traverse is performed:
 0: With a constant inclination.
 1: With a constant time.

NOTE

This parameter is invalid if the function of bell-shaped acceleration/deceleration after rapid-traverse interpolation is provided. The acceleration/deceleration time constant and override for rapid traverse are used.

RBL In the AI contour control mode, acceleration/deceleration of rapid traverse is:
 0: Linear acceleration/deceleration.
 1: Bell-shaped acceleration/deceleration.

NOTE

Bit 4 (PRT) of parameter No. 1603 is invalid.

BEL In AI contour control mode:
 0 : Linear acceleration/deceleration before look-ahead interpolation is used.
 1 : Bell-shaped acceleration/deceleration before look-ahead interpolation is used.

	#7	#6	#5	#4	#3	#2	#1	#0
1610				JGLx			CTBx	CTLx

[Data type] Bit axis

CTLx Acceleration/deceleration in cutting feed including feed in dry run
 0 : Exponential acceleration/deceleration is applied.
 1 : Linear acceleration/deceleration after interpolation is applied.

NOTE

If the optional function of linear acceleration/deceleration after interpolation in cutting feed is not provided, exponential acceleration/deceleration is used irrespective of this setting. To use bell-shaped acceleration/deceleration after interpolation, set this parameter to 0 and select the acceleration/deceleration using CTBx, bit 1 of parameter No.1610.

Parameter		Acceleration/deceleration
CTBx	CTLx	
0	0	Exponential acceleration/deceleration
0	1	Linear acceleration/deceleration after interpolation
1	0	Bell-shaped acceleration/deceleration after interpolation

- CTBx** Acceleration/deceleration in cutting feed including feed in dry run
 0 : Exponential acceleration/deceleration or linear acceleration/deceleration after interpolation is applied (depending on the setting in CTLx, bit 0 of parameter No.1610).
 1 : Bell-shaped acceleration/deceleration after interpolation is applied.

NOTE

This parameter is effective only when the function of bell-shaped acceleration/deceleration after interpolation in cutting feed is provided. If the function is not provided, the setting in CTLx, bit 0 of parameter No.1610, determines the type of acceleration/deceleration irrespective of the setting in this parameter.

- JGLx** Acceleration/deceleration in jog feed
 0 : Exponential acceleration/deceleration is applied.
 1 : Linear acceleration/deceleration after interpolation or bell-shaped acceleration/deceleration after interpolation is applied (depending on which is used for cutting feed).

1620

Time constant T or T_1 used for linear acceleration/deceleration or bell-shaped acceleration/deceleration in rapid traverse for each axis

[Data type] Word axis

[Unit of data] ms

[Valid data range] 0 to 4000

Specify a time constant used for acceleration/deceleration in rapid traverse. When the optional function of bell-shaped acceleration/deceleration in rapid traverse is provided, bell-shaped acceleration/deceleration is applied in rapid traverse. If the function is not provided, linear acceleration/deceleration is applied.

- (1) When the function is provided, set this parameter to time constant T_1 used in bell-shaped acceleration/deceleration in rapid traverse, and set parameter No.1621 to time constant T_2 .
- (2) When the function is not provided, specify a time constant used in linear acceleration/deceleration.

NOTE

When parameter No.1621 (time constant T_2 used for bell-shaped acceleration/deceleration in rapid traverse) is set to 0, linear acceleration/deceleration is applied in rapid traverse even if the function is provided. In this case, this parameter stands for a time constant used in linear acceleration/deceleration in rapid traverse.

<Rapid traverse linear acceleration/deceleration>

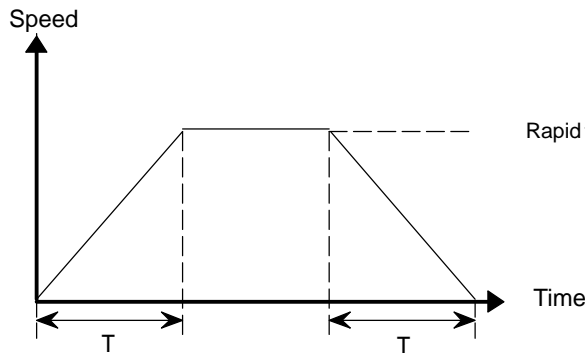

T: Time constant for linear acceleration/deceleration

<Rapid traverse bell shaped acceleration/deceleration>

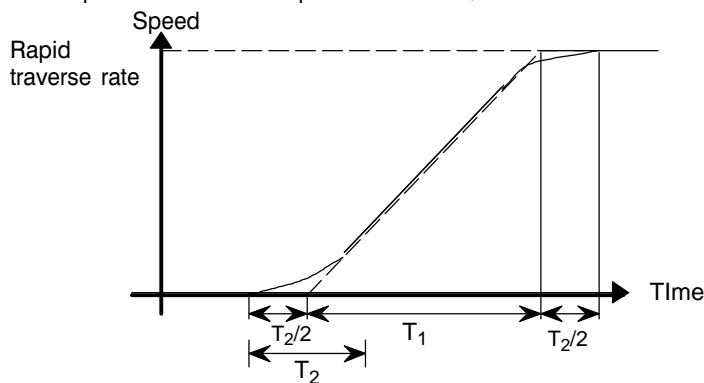

T_1 : Set a time constant used for linear acceleration/deceleration

T_2 : Set a time for rounding.

Total time= $T_1 + T_2$

Time for linear= $T_1 - T_2$

Time for rounding part= T_2

Set the value when the rapid traverse rate is 100%. If it is under 100%, the total time is reduced. (Constant acceleration method)

The value of T_1 is determined from the torque of motor. Usually set the value of T_2 to 24 ms or 32 ms.

1621	Time constant T_2 used for bell-shaped acceleration/deceleration in rapid traverse for each axis
------	--

[Data type] Word axis

[Unit of data] ms

[Valid data range] 0 to 512

Specify time constant T_2 used for bell-shaped acceleration/deceleration in rapid traverse for each axis.

NOTE

- 1 This parameter is effective when the function of bell-shaped acceleration/deceleration in rapid traverse is provided. Set parameter No.1620 to time constant T_1 used for bell-shaped acceleration/deceleration in rapid traverse, and set this parameter to time constant T_2 . For details of time constants T_1 and T_2 , see the description of parameter No.1620.
- 2 When this parameter is set to 0, linear acceleration/deceleration is applied in rapid traverse. The setting in parameter No.1620 is used as a time constant in linear acceleration/deceleration.

1622

Time constant of exponential acceleration/deceleration or bell-shaped acceleration/deceleration after interpolation, or linear acceleration/deceleration after interpolation in cutting feed for each axis

[Data type] Word axis

[Unit of data] ms

[Valid data range] 0 to 4000(exponential acceleration/deceleration in cutting feed)
 0 to 512 (linear or bell-shaped acceleration/deceleration after interpolation in cutting feed)

Set the time constant used for exponential acceleration/deceleration in cutting feed, bell-shaped acceleration/deceleration after interpolation or linear acceleration/deceleration after interpolation in cutting feed for each axis. Except for special applications, the same time constant must be set for all axes in this parameter. If the time constants set for the axes differ from each other, proper straight lines and arcs cannot be obtained.

This parameter is valid for threading, irrespective of the acceleration/deceleration type. For threading cycles G76 and G92 (G78 in the G code system B or C), this parameter is valid for operations other than exponential acceleration/deceleration. (T series)

Bell-shaped acceleration/deceleration after cutting feed interpolation

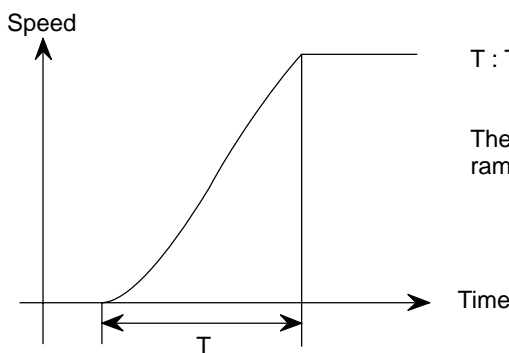

T : Total time. it is constant irrespective of feed rate.
 (Time constant is constant).

The curve corresponds to that $T_1 = T/2$ and $T_2 = T/2$ set in parameter No.1620 and 1621.

1623

FL rate of exponential acceleration/deceleration in cutting feed for each axis

[Data type] Word axis**[Unit of data]****[Valid data range]**

Increment system	Unit of data	Valid data range	
		IS-A, IS-B	IS-C
Millimeter machine	1 mm/min	0,6 to 15000	0,6 to 12000
Inch machine	0.1 inch/min	0,6 to 6000	0,6 to 4800
Rotaion axis	1 deg/min	0,6 to 15000	0,6 to 12000

Set the lower limit (FL rate) of exponential acceleration/deceleration in cutting feed for each axis.

NOTE

Except for special applications, this parameter must be set to 0 for all axes. If a value other than 0 is specified, proper straight lines and arcs cannot be obtained.

1624

Time constant of exponential acceleration/deceleration or bell-shaped acceleration/deceleration or linear acceleration/deceleration after interpolation, in jog feed for each axis.

[Data type] Word axis**[Unit of data]** ms

[Valid data range] 0 to 4000(exponential acceleration/deceleration in jog feed)
0 to 512 (linear or bell-shaped acceleration/deceleration after interpolation in jog feed)

Set the time constant used for exponential acceleration/deceleration, bell-shaped acceleration/deceleration or linear acceleration/deceleration after interpolation in jog feed fot each axis. The type to select depends on the settings of the parameters CTLx, CTBx, and JGLx (Nos. 1610#0, #1, and #4).

1625

FL rate of exponential acceleration/deceleration in jog feed for each axis.

[Data type] Word axis**[Unit of data]****[Valid data range]**

Increment system	Unit of data	Valid data range	
		IS-A, IS-B	IS-C
Millimeter machine	1 mm/min	6 to 15000	6 to 12000
Inch machine	0.1 inch/min	6 to 6000	6 to 4800
Rotaion axis	1 deg/min	6 to 15000	6 to 12000

Set the lower limit (FL rate) of exponential acceleration/deceleration in cutting feed for each axis.

1626	Time constant of exponential acceleration/deceleration in the thread cutting cycle for each axis

[Data type] Word axis

[Unit of data] ms

[Valid data range] 0 to 4000

Set the time constant used for exponential acceleration/deceleration in the thread cutting cycle (G76, G78 (G92 in G code system A)) for each axis. If the acceleration type is not exponential acceleration/deceleration, parameter No. 1622 becomes valid.

1627	FL rate of exponential acceleration /deceleration in the thread cutting cycle for each axis

[Data type] Word axis

[Unit of data]

[Valid data range]

Increment system	Unit of data	Valid data range	
		IS-A, IS-B	IS-C
Millimeter machine	1 mm/min	6 to 15000	6 to 12000
Inch machine	0.1 inch/min	6 to 6000	6 to 4800
Rotation axis	1 deg/min	6 to 15000	6 to 12000

Set the lower limit (FL rate) of exponential acceleration/deceleration in the thread cutting cycle (G76, G78 (G92 in G code system A)) for each axis.

1630	Parameter 1 for setting an acceleration for linear acceleration/deceleration before interpolation (maximum machining feedrate during linear acceleration/deceleration before interpolation)

[Data type] 2-word

Increment system	Unit of data	Valid data range	
		IS-A, IS-B	IS-C
Millimeter machine	1 mm/min	6 to 240000	6 to 100000
Inch machine	0.1 inch/min	6 to 96000	6 to 48000

This parameter is used to set an acceleration for linear acceleration/deceleration before interpolation. In this parameter, set a maximum machining speed during linear acceleration/deceleration before interpolation. In parameter No.1631, set a time used to reach the maximum machining speed.

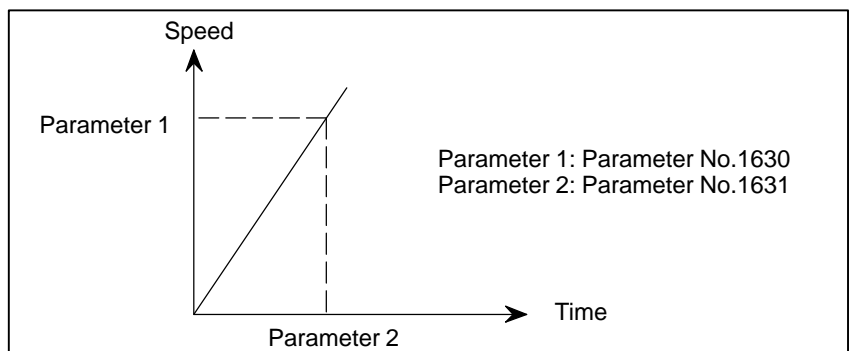

NOTE

- 1 When 0 is set in parameter No.1630 or parameter No.1631, linear acceleration/deceleration before interpolation is disabled.
- 2 In the look-ahead control mode, parameter No.1770 and parameter No.1771 are valid.

1631

Parameter 2 for setting an acceleration for linear acceleration/deceleration before interpolation (time used to reach the maximum machining speed during linear acceleration/deceleration before interpolation.)

[Data type] Word**[Unit of data]** 1 ms**[Valid data range]** 0 to 4000

This parameter is used to set an acceleration for linear acceleration/deceleration before interpolation. In this parameter, set the time (time constant) used to reach the speed set in parameter No.1630.

NOTE

- 1 When 0 is set in parameter No.1630 or parameter No.1631, linear acceleration/deceleration before interpolation is disabled.
- 2 In parameter Nos. 1630 and 1631, set values that satisfy the following:
Parameter No.1630/Parameter No.1631 ≥ 5
- 3 In the look-ahead control mode, parameter No.1770 and parameter No.1771 are valid.

1710

Minimum deceleration ratio (MDR) of the inner circular cutting rate in automatic corner override

[Data type] Byte**[Unit of data]** %**[Valid data range]** 1 to 100

This parameter sets the minimum deceleration ratio (MDR) when the inner circular cutting speed is changed by automatic corner override.

In circular cutting with an inward offset, the actual feedrate for a specified feedrate (F) is expressed as follows:

$$F \times \frac{Rc}{Rp} \left(\begin{array}{l} \mathbf{Rc: Radius of the path of the cutter's center.} \\ \mathbf{Rp: Programmed radius} \end{array} \right)$$

Then, the actual feedrate is controlled so that the feedrate on the programmed path can achieve the specified feedrate F.

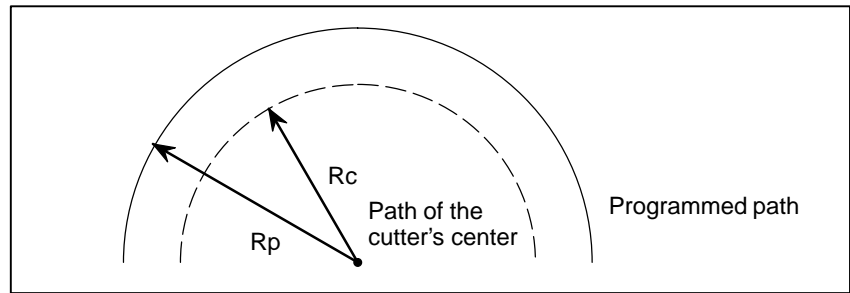

Fig. 4.17 (a) R_p and R_c

If R_c is too small in comparison with R_p , such that $R_c/R_p \cong 0$, the cutter will stop. To prevent this, a minimum deceleration ratio (MDR) is set.

1711	Angle (θ_p) used to recognize an inner corner in inner corner override
------	---

[Data type] Byte

[Unit of data] Degree

[Valid data range] 1 to 179 (standard value = 91)

This parameter sets the angle used to recognize an inner corner for inner corner override by automatic corner override.

1712	Amount of override for an inner corner
------	--

[Data type] Byte

[Unit of data] %

[Valid data range] 1 to 100 (standard value = 50)

Set the amount of override for an inner corner.

1713	Distance L_e from the starting point in inner corner override
------	---

[Data type] Word

[Unit of data]

Increment system	IS-A	IS-B	IS-C	Unit
Millimeter input	1	0.1	0.01	mm
Inch input	0.1	0.01	0.001	inch

[Valid data range] 0 to 3999

Set distance L_e from the starting point in an inner corner for corner override.

1714	Distance L_s up to the ending point in inner corner override
------	--

[Data type] Word

[Unit of data]

Increment system	IS-A	IS-B	IS-C	Unit
Millimeter input	1	0.1	0.01	mm
Inch input	0.1	0.01	0.001	inch

[Valid data range] 0 to 3999

Set distance L_s up to the end point in an inner corner for corner override.
 If $\theta \leq \theta_p$, the inside of a corner is recognized. (θ_p is set in parameter 1711.)

When an inner corner is recognized, the feedrate is overridden in the range of L_e in the block immediately before the intersection of the corner and L_s in the next block following the intersection.

L_s and L_e are each a straight line connecting the intersection of the corner and a given point on the path of the cutter's center.

L_s and L_e are set in parameters 1713 and 1714.

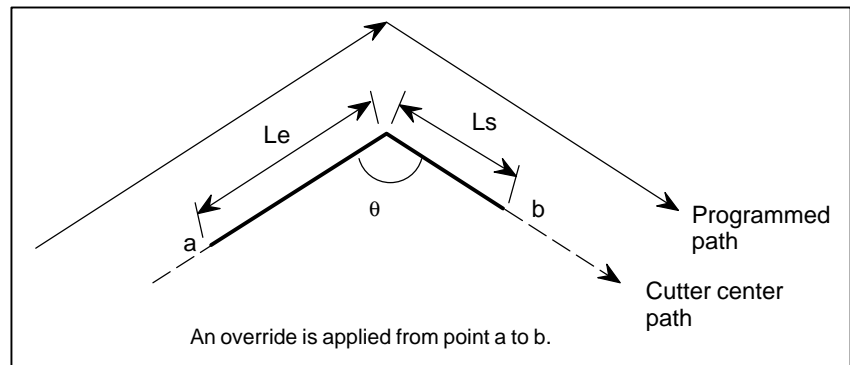

Fig.4.17 (b) Distance L_e and L_s in the automatic corner override at an inner corner

1722	Rapid traverse feedrate reduction ratio for overlapping rapid traverse blocks
------	---

[Data type] Byte axis

[Unit of data] %

[Valid data range] 1 to 100

This parameter is used when rapid traverse blocks are arranged successively, or when a rapid traverse block is followed by a block that does not cause movement. When the feedrate for each axis of a block is reduced to the ratio set in this parameter, the execution of the next block is started.

Examples

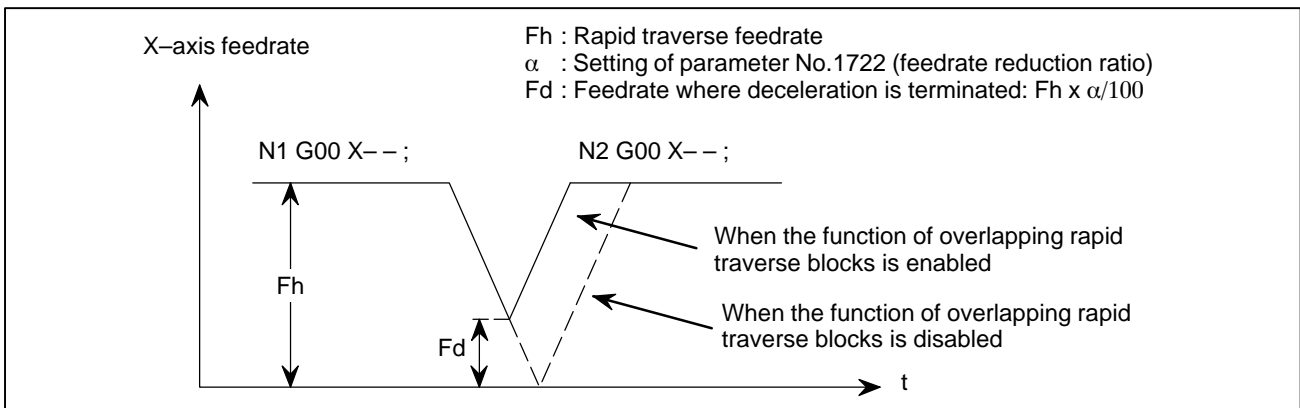

NOTE

The parameter No.1722 is effective when parameter No.1601 #4 (RT0) is set to 1.

1730	
	Maximum feedrate for arc radius R

[Data type] Word

[Unit of data]

Increment system	Unit of data	Valid data range	
		IS-A, IS-B	IS-C
Millimeter machine	1 mm/min	8 to 15000	0 to 12000
Inch machine	0.1 inch/min	8 to 6000	0 to 4800

Set a maximum feedrate for the arc radius set in parameter No.1731. Set this parameter when the arc radius-based feedrate clamping function is enabled.

1731	
	Arc radius value corresponding to a maximum feedrate

[Data type] 2-word

[Unit of data]

Unit	IS-A	IS-B	IS-C	Unit
Linear axis (millimeter machine)	0.01	0.001	0.0001	mm
Linear axis (inch machine)	0.001	0.0001	0.00001	inch

[Valid data range] 1000 to 99999999

Set the arc radius corresponding to the maximum feedrate set in parameter No.1730. Set this parameter when the arc radius-based feedrate clamping function is enabled.

1732	
	Minimum value (RV min) for arc radius-based feedrate clamp

[Data type] Word

Increment system	Unit of data	Valid data range	
		IS-A, IS-B	IS-C
Millimeter machine	1 mm/min	0 to 15000	0 to 12000
Inch machine	0.1 inch/min	0 to 6000	0 to 4800

The arc radius-based feedrate clamping function reduces the maximum feedrate as the arc radius decreases. When the specified maximum feedrate is not greater than RV min (minimum value for arc radius-based feedrate clamping), RV min is used as the maximum feedrate.

1740	
	Critical angle subtended by two blocks for automatic corner deceleration

[Data type] 2-word

[Unit of data] 0.001 deg

[Valid data range] 0 to 180000

Set a critical angle to be subtended by two blocks for corner deceleration when the angle-based automatic corner deceleration function is used.

The angle subtended by two blocks is defined as θ in the examples shown below.

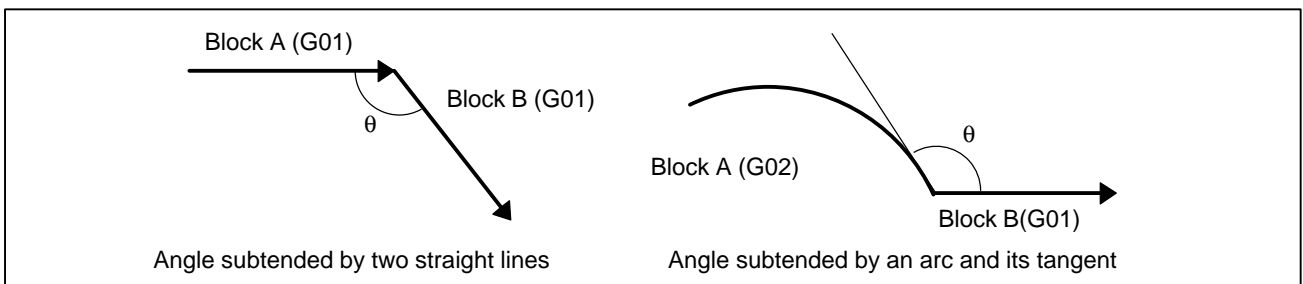

1741	
	Feedrate for assuming the termination of automatic corner deceleration (for acceleration/deceleration after interpolation)

[Data type] Word axis

[Unit of data]

Increment system	Unit of data	Valid data range	
		IS-A, IS-B	IS-C
Millimeter machine	1 mm/min	6 to 15000	6 to 12000
Inch machine	0.1 inch/min	6 to 6000	6 to 4800
Rotation axis	1 deg/min	6 to 15000	6 to 12000

Set the feedrate for assuming the termination of deceleration in automatic corner deceleration.

1762	
	Exponential acceleration/deceleration time constant for cutting feed in the look-ahead control mode

[Data type] Word axis

[Unit of data] 1 ms

[Valid data range] 0 to 4000

Set an exponential acceleration/deceleration time constant for cutting feed in the look-ahead control mode.

1763	
	Minimum speed in exponential acceleration/deceleration for cutting feed in the look-ahead control mode

[Data type] Word axis

Increment system	Unit of data	Valid data range	
		IS-A, IS-B	IS-C
Millimeter machine	1 mm/min	6 to 15000	6 to 12000
Inch machine	0.1 inch/min	6 to 6000	6 to 4800
Rotation axis	1 deg/min	6 to 15000	6 to 12000

Set minimum speed (FL) in exponential acceleration/deceleration for cutting feed in the look-ahead control mode.

1768	
	Time constant for linear acceleration/deceleration or bell-shaped acceleration/deceleration during cutting feed in lock-ahead control mode.

[Data type] Word

[Unit of data] ms

[Valid data range] 8 to 512

This parameter sets a time constant for linear acceleration/deceleration for cutting feed in the look-ahead control mode.

NOTE

- 1 For linear acceleration/deceleration, the function of linear acceleration/deceleration after cutting feed interpolation is required.
- 2 For bell-shaped acceleration/deceleration, the function of bell-shaped acceleration/deceleration after cutting feed interpolation is required.

1770	
	Parameter 1 (for look-ahead control) for setting an acceleration for linear acceleration/deceleration before interpolation (maximum machining speed during linear acceleration/deceleration before interpolation)

[Data type] 2-word

[Unit of data, valid range]

Increment system	Unit of data	Valid data range	
		IS-A, IS-B	IS-C
Millimeter machine	1 mm/min	6 to 240000	6 to 100000
Inch machine	0.1 inch/min	6 to 96000	6 to 48000

This parameter is used to set an acceleration for linear acceleration/deceleration before interpolation in the look-ahead control mode. In this parameter, set the maximum machining speed during linear acceleration/deceleration before interpolation. Set the time used to reach the maximum machining speed in parameter No.1771.

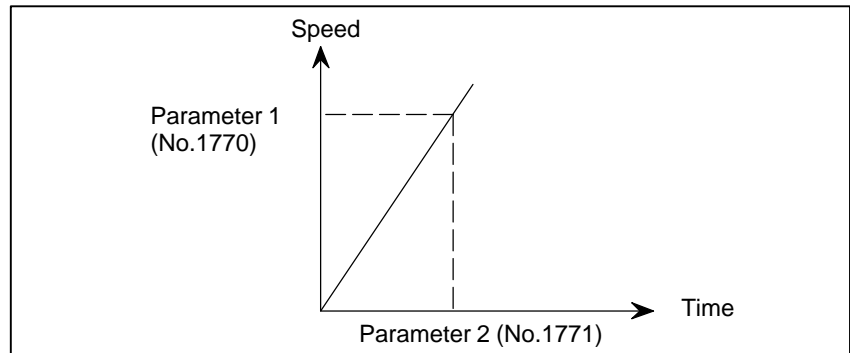
**NOTE**

When 0 is set in parameter No.1770 or parameter No.1771, linear acceleration/deceleration before interpolation is disabled.

1771	Parameter2 (for look-ahead control) for setting an acceleration for linear acceleration/deceleration before interpolation (time used to reach the maximum machining speed during linear acceleration/deceleration before interpolation)
------	---

[Data type] Word

[Unit of data] 1 msec

[Valid range] 0 to 4000

This parameter is used to set an acceleration for linear acceleration/deceleration before interpolation in the look-ahead control mode. In this parameter, set the time (time constant) used to reach the speed set in parameter No.1770.

NOTE

1 When 0 is set in parameter No.1770 or parameter No.1771, linear acceleration/deceleration before interpolation is disabled.

2 In parameter Nos. 1770 and 1771, set values that satisfy the following:

$$\text{Parameter No.1770/Parameter No.1771} \geq 5$$

1772	Time constant for bell-shaped acceleration/deceleration of acceleration time fixed type before look-ahead interpolation
------	---

[Data type] Byte

[Unit of data] ms

[Valid data range] 0 to 100

This parameter is used to set a time constant when the BEL parameter (bit 7 of parameter No.1603) is set to 1, that is, when bell-shaped acceleration/deceleration before look-ahead interpolation is selected in AI contour control mode. Set the value of tb as shown below. When 0 is set, linear acceleration/deceleration before interpolation is applied.

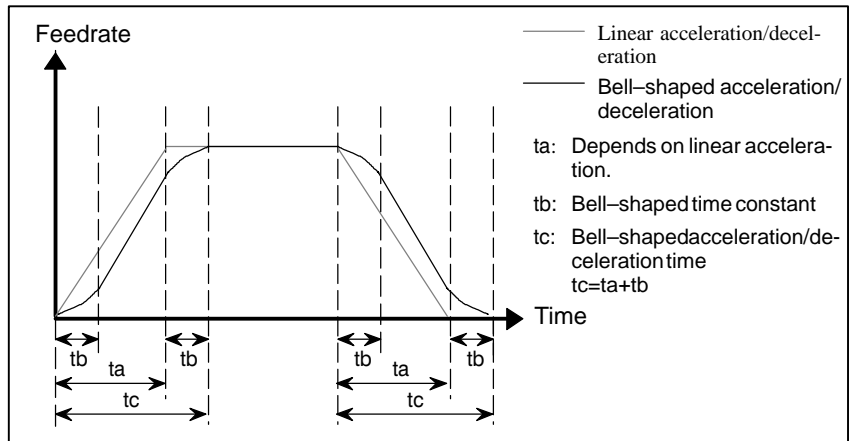

NOTE

The option for bell-shaped acceleration/deceleration before look-ahead interpolation is required. This parameter is enabled only in AI contour control mode.

1775	(Must not be used)*(Always set 0.)
1776	(Must not be used)*(Always set 0.)
1777	Minimum speed for the automatic corner deceleration function (look-ahead control)

[Data type] Word

[Unit of data, valid range]

Increment system	Unit of data	Valid data range	
		IS-A, IS-B	IS-C
Millimeter machine	1 mm/min	6 to 15000	6 to 12000
Inch machine	0.1 inch/min	6 to 6000	6 to 4800
Rotation axis	1 deg/min	6 to 15000	6 to 12000

Set a speed at which the number of buffered pulses in deceleration is assumed to be 0 when linear acceleration/deceleration before interpolation is used.

1778	Minimum speed of for the automtic corner deceleration function (for linear acceleration/deceleration before interpolation)
------	--

[Data type] Word

[Unit of data, valid range]

Increment system	Unit of data	Valid data range	
		IS-A, IS-B	IS-C
Millimeter machine	1 mm/min	6 to 15000	6 to 12000
Inch machine	0.1 inch/min	6 to 6000	6 to 4800
Rotation axis	1 deg/min	6 to 15000	6 to 12000

Set a speed at which the number of buffered pulses in deceleration is assumed to be 0 when linear acceleration/deceleration before interpolation is used.

1779	
	Critical angle subtended by two blocks for automatic corner deceleration (for look-ahead control)

[Data type] 2-word

[Unit of data] 0.001 deg

[Valid data range] 0 to 180000

Set a critical angle to be subtended by two blocks for corner deceleration when the angle-based automatic corner deceleration function is used.

The angle subtended by two blocks is defined as θ in the examples shown below.

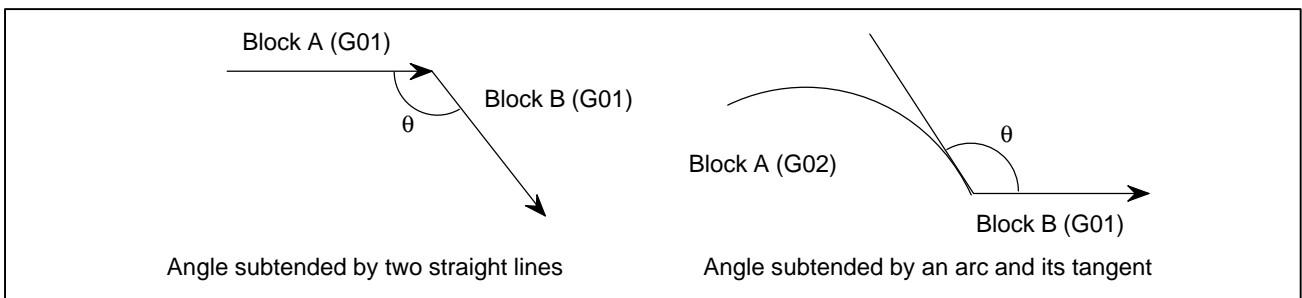

1780	
	Allowable speed difference for the speed difference-based corner deceleration function (for linear acceleration/deceleration before interpolation)

[Data type] Word

[Unit of data, valid range]

Increment system	Unit of data	Valid range	
		IS-A, IS-B	IS-C
Millimeter machine	1 mm/min	6 to 15000	6 to 12000
Inch machine	0.1 inch/min	6 to 6000	6 to 4800

Set the speed difference for the speed difference-based automatic corner deceleration function when linear acceleration/deceleration before interpolation is used.

1781	
	Allowable speed difference for the speed difference-based corner deceleration function (linear acceleration/deceleration after interpolation)

[Data type] Word axis

[Unit of data, valid range]

Increment system	Unit of data	Valid range	
		IS-A, IS-B	IS-C
Millimeter machine	1 mm/min	6 to 15000	6 to 12000
Inch machine	0.1 inch/min	6 to 6000	6 to 4800
Rotation axis	0.1 deg/min	6 to 15000	6 to 12000

Set speed difference for the speed difference-based automatic corner deceleration function when linear acceleration/deceleration after interpolation used.

1783	
	Allowable speed difference for the speed difference based corner deceleration function (linear acceleration/deceleration before interpolation)

[Data type] Word axis

[Unit of data, valid range]

Increment system	Unit of data	Valid range	
		IS-A, IS-B	IS-C
Millimeter machine	1 mm/min	6 to 15000	6 to 12000
Inch machine	0.1 inch/min	6 to 6000	6 to 4800
Rotation axis	0.1 deg/min	6 to 15000	6 to 12000

A separate allowable feedrate difference can be set for each axis. The allowable feedrate difference is set for each axis with this parameter. Among the axes that exceed the specified allowable feedrate difference, the axis with the greatest ratio of the actual feedrate difference to the allowable feedrate difference is used as the reference to calculate the reduced feedrate at the corner.

1784	
	Speed when overtravel alarm has generated during acceleration/deceleration before interpolation

[Data type] Word axis

[Unit of data]

[Valid data range]

Increment system	Unit of data	Valid range	
		IS-A, IS-B	IS-C
Millimeter machine	1 mm/min	6 to 15000	6 to 12000
Inch machine	0.1 inch/min	6 to 6000	6 to 4800

Deceleration is started beforehand to reach the feedrate set in the parameter when an overtravel alarm is issued (when a limit is reached) during linear acceleration/deceleration before interpolation. By using this parameter, the overrun distance that occurs when an overtravel alarm is output can be reduced.

NOTE

- 1 When 0 is set in this parameter, the control described above is not exercised.
- 2 Use type-B linear acceleration/deceleration before interpolation (by setting bit 0 (FWB) of parameter No.1602 to 1).
- 3 The control described above is applicable only to stored stroke check 1.

1785	Parameter for determining an allowable acceleration when the feedrate is set by acceleration
------	--

[Data type] Word-axis

[Unit of data] ms

[Valid data range] 0 to 32767

This parameter sets the time required to attain the maximum cutting feedrate to determine the allowable acceleration when the feedrate is determined by acceleration in AI contour control mode.

The maximum cutting feedrate and the data set in this parameter are used to determine the allowable acceleration. As the maximum cutting feedrate parameter, parameter No.1432 (maximum cutting feedrate in AI contour control mode) is used.

4.18 PARAMETERS OF SERVO

	#7	#6	#5	#4	#3	#2	#1	#0
1800			TRC	RBK	FFR	OZR	CVR	

[Data type] Bit

CVR When velocity control ready signal VRDY is set ON before position control ready signal PRDY comes ON
 0: A servo alarm is generated.
 1: A servo alarm is not generated.

OZR When manual reference position return is attempted in the halt state during automatic operation (feed hold stop state) under any of the conditions listed below:
 0: Manual reference position return is not performed, with P/S alarm No.091.
 1: Manual reference position return is performed without an alarm occurring.

< Conditions >

- (1) When there is a remaining distance to travel.
- (2) When an auxiliary function (miscellaneous function, spindle-speed function, tool function) is being executed.
- (3) When a cycle such as a dwell cycle or canned cycle is being executed.

FFR Feed-forward control is enabled for
 0 : Cutting feed only
 1 : Cutting feed and rapid traverse

RBK Backlash compensation applied separately for cutting feed and rapid traverse
 0: Not performed
 1: Performed

TRC The servo trace function is:
 0 : Disabled
 1 : Enabled (Also set parameter No.1870.)

The digital servo software for learning control is necessary.

	#7	#6	#5	#4	#3	#2	#1	#0
1801				CCI			PM2	PM1
			CIN	CCI				

[Data type] Bit

PM1, PM2 Sets a gear ratio between the spindle and motor when the servo motor-based speed control function is used.

Magnification	PM2	PM1
1/1	0	0
1/2	0	1
1/4	1	0
1/8	1	1

$$\text{Magnification} = \frac{\text{spindle speed}}{\text{motor speed}}$$

CCI The in-position area for cutting feed is:
 0 : Set in parameter No.1826 (same as for rapid traverse).
 1 : Set in bit 5 (CIN) of parameter No.1801.

- CIN** When bit 4 (CCI) of parameter No.1801 = 1, the in-position area for cutting feed is:
 0 : Use value in parameter No.1827 if the next block is also for cutting feed, or use value in parameter No.1826 if the next block is not for cutting feed.
 1 : Use value in parameter No.1827, regardless of the next block. (The setting of parameter No.1826 is used for rapid traverse, and the setting of parameter No.1827 is used for cutting feed.)

	#7	#6	#5	#4	#3	#2	#1	#0
1802			DPS	B15		DC2	DC4	CTS
	FWC			B15		DC2	DC4	

NOTE

After this parameter is set, the power needs to be turned off.

[Data type] Bit

- CTS** The servo motor-based speed control function is:
 0 : Not used
 1 : Used
- DC4** When the reference position is established on the linear scale with reference marks:
 0 : An absolute position is established by detecting three reference marks.
 1 : An absolute position is established by detecting four reference marks.
- DC2** The reference position on the linear scale with absolute addressing reference marks is established:
 0 : As determined by bit 1 (DC4) of parameter No. 1802.
 1 : By establishing the absolute position through detection of two reference marks.
- B15** In backlash compensation, the travel direction is determined:
 0 : Without consideration of the compensation amount (pitch error, straightness, external machine coordinate shift, etc.).
 1 : In consideration of the compensation amount. (FS15 format)
- DPS** When servo motor-based speed control is applied, a position coder is:
 0 : Used
 1 : Not used
- FWC** The processing of command multiplication (CMR) is performed:
 0 : After acceleration/deceleration after interpolation.
 1 : Before acceleration/deceleration after interpolation.

	#7	#6	#5	#4	#3	#2	#1	#0
1803				TQF			TQA	TQI

[Data type] Bit

- TQI** While torque restriction is applied, in-position check is:
 0 : Performed.
 1 : Not performed.

TQA While torque restriction is applied, checking for an excessive error in the stopped state/during movement is:

0 : Performed.

1 : Not performed.

TQF When torque control is performed by an axis control command of the PMC axis control function, follow-up operation is:

0 : Not performed.

1 : Performed.

	#7	#6	#5	#4	#3	#2	#1	#0
1804		SAK	ANA	IVO			BLC	

[Data type] Bit axis

BLC During circular interpolation by jog feed (manual circular interpolation function), the backlash acceleration function is:

0 : Disabled.

1 : Enabled.

IVO When an attempt is made to release an emergency stop while the VRDY OFF alarm ignore signal is 1:

0 : The emergency stop state is not released until the VRDY OFF alarm ignore signal is set to 0.

1 : The emergency stop state is released.

NOTE

When a reset is issued while the VRDY OFF alarm ignore signal is set to 1 and the motor activating current is low, the reset state can also be released, provided this parameter is set to 1.

ANA When an abnormal load is detected for an axis:

0 : Movement along all axes is stopped, and a servo alarm is output.

1 : No servo alarm is output, and movement along only the axes of the group containing the axis with the abnormal load is stopped in interlock mode. (The group number of each axis is set in parameter No.1881.)

SAK When the VRDY OFF alarm ignore signal IGNVRY is 1, or when the VRDY OFF alarm ignore signals IGVRVY1 to IGVRVY8 are 1:

0 : Servo ready signal SA is set to 0.

1 : Servo ready signal SA remains set to 1.

	#7	#6	#5	#4	#3	#2	#1	#0
1805							TQU	

[Data type] Bit

TQU If follow-up is not performed by the torque control command of PMC axis control, the servo error counter is:

0: Updated.

1: Not updated.

NOTE

- 1 This parameter is valid if follow-up is not performed (bit 4 (TQF) of parameter No. 1803 is set to 0).
- 2 When torque control is switched to position control, a reference position return must be made.

	#7	#6	#5	#4	#3	#2	#1	#0
1815			APCx	APZx		DCLx	OPTx	

NOTE

When this parameter has been set, the power must be turned off before operation is continued.

[Data type] Bit axis

OPTx Position detector

- 0 : A separate pulse coder is not used.
- 1 : A separate pulse coder is used.

For an absolute-position system using Inductosyn, set this parameter to 1.

DCLx As a separate position detector, the linear scale with reference marks is:

- 0 : Not used.
- 1 : Used.

NOTE

When using the linear scale with reference marks, also set the OPTx parameter (bit 1 of parameter No.1815) to 1.

APZx Machine position and position on absolute position detector when the absolute position detector is used

- 0 : Not corresponding
- 1 : Corresponding

NOTE

When an absolute position detector is used, after primary adjustment is performed or after the absolute position detector is replaced, this parameter must be set to 0, power must be turned off and on, then manual reference position return must be performed. This completes the positional correspondence between the machine position and the position on the absolute position detector, and sets this parameter to 1 automatically.

APCx Position detector

- 0 : Other than absolute position detector
- 1 : Absolute position detector (absolute pulse coder)

For an absolute-position system using Inductosyn, set this parameter to 1.

	#7	#6	#5	#4	#3	#2	#1	#0
1817		TANx		SCPx				

NOTE

When this parameter has been set, the power must be turned off before operation is continued.

[Data type] Bit axis

SCPx If bit 2 (DC2) of parameter No. 1802 is set to 1, the scale zero point of the linear scale with absolute addressing reference marks is:

- 0: On the negative direction side. (Viewed from the scale zero point, the reference position is on the positive direction side.)
- 1: On the positive direction side. (Viewed from the scale zero point, the reference position is on the negative direction side.)

TANx Tandem control

- 0: Not used
- 1: Used

NOTE

Set this parameter to both master axis and slave axis.

	#7	#6	#5	#4	#3	#2	#1	#0
1818						DG0x	RF2x	RFSx

[Data type] Bit axis type

RFSx On an axis using a linear scale with absolute addressing reference marks, if an automatic reference position return (G28) is made before the reference position is established, the reference position is established first, then:

- 0: A movement to the reference position is made.
- 1: A movement to the reference position is not made, but the operation is completed.

RF2x On an axis using a linear scale with absolute addressing reference marks, if an automatic reference position return (G28) is made after the reference position is established,

- 0: A movement to the reference position is made.
- 1: A movement to the reference position is not made, but the operation is completed.

DG0x On an axis using a linear scale with absolute addressing reference marks, a reference position return by jog feed or a rapid traverse command is:

- 0: Disabled.
- 1: Enabled.

	#7	#6	#5	#4	#3	#2	#1	#0
1819						DATx	CRFx	FUPx
	NAHx					DATx	CRFx	FUPx

[Data type] Bit axis

FUPx To perform follow-up when the servo is off is set for each axis.

0: The follow-up signal, *FLWU, determines whether follow-up is performed or not.

When *FLWU is 0, follow-up is performed.

When *FLWU is 1, follow-up is not performed.

1: Follow-up is not performed.

NOTE

When the index table indexing function (M series) is used, be sure to set FUPx of the 4th axis to 1.

CRFx When servo alarm No.445 (software disconnection), No.446 (hardware disconnection), No.447 (hardware disconnection (separate type)), or No.421 (excessive dual position feedback error) is issued:

0: The reference position setting remains as is.

1: The system enters the reference position undefined state.

DATx On a linear scale with absolute addressing reference marks, the automatic setting of parameters No. 1883 and No. 1884 is:

0: Not performed.

1: Performed.

NOTE

This parameter is automatically set to 0 when the manual reference position return is completed.

NAHx In the look-ahead control mode, advanced feed-forward is:

0: Used

1: Not used

NOTE

Set1 for a PMC-based control axis.

1820

Command multiplier for each axis (CMR)

NOTE

When this parameter has been set, the power must be turned off before operation is continued.

[Data type] Byte axis

Set a command multiplier indicating the ratio of the least command increment to the detection unit for each axis.

Least command increment = detection unit × command multiplier

Relationship between the increment system and the least command increment

(1) T series

			Least input increment	Least command increment
IS-B	Millimeter machine	Millimeter input	0.001 mm (diameter specification)	0.0005 mm
			0.001 mm (radius specification)	0.001 mm
		Inch input	0.0001 inch (diameter specification)	0.0005 mm
			0.0001 inch (radius specification)	0.001 mm
	Inch machine	Millimeter input	0.001 mm (diameter specification)	0.00005 inch
			0.001 mm (radius specification)	0.0001 inch
		Inch input	0.0001 inch (diameter specification)	0.00005 inch
			0.0001 inch (radius specification)	0.0001 inch
Rotation axis			0.001 deg	0.001 deg

			Least input increment	Least command increment
IS-C	Millimeter machine	Millimeter input	0.0001 mm (diameter specification)	0.00005 mm
			0.0001 mm (radius specification)	0.0001 mm
		Inch input	0.00001 inch (diameter specification)	0.00005 mm
			0.00001 inch (radius specification)	0.0001 mm
	Inch machine	Millimeter input	0.0001 mm (diameter specification)	0.000005 inch
			0.0001 mm (radius specification)	0.00001 inch
		Inch input	0.00001 inch (diameter specification)	0.000005 inch
			0.00001 inch (radius specification)	0.00001 inch
Rotation axis			0.0001 deg	0.0001 deg

(2) M series

Increment system	Least input increment and least command increment			
	IS-A	IS-B	IS-C	Units
Millimeter machine	0.01	0.001	0.0001	mm
Inch machine	0.001	0.0001	0.00001	inch
Rotation axis	0.01	0.001	0.0001	deg

Setting command multiply (CMR), detection multiply (DMR), and the capacity of the reference counter

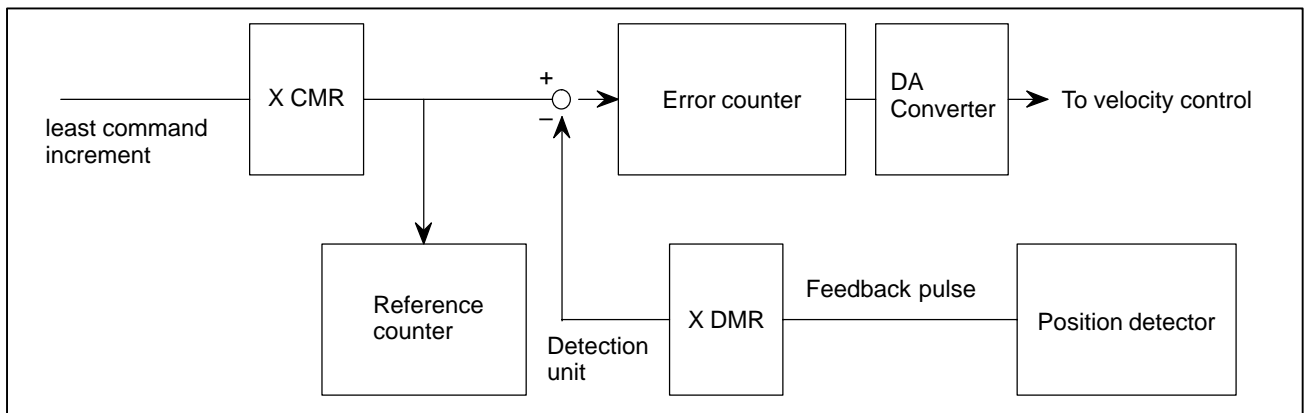

Fig.4.18 (a) CMR, DMR, and the Capacity of the Reference Counter

Set the magnification ratios of CMR and DMR so that the weight of positive inputs to the error counter equals that of negative inputs.

$$\frac{\text{Least command increment}}{\text{CMR}} = \text{detection unit} = \frac{\text{feedback pulse unit}}{\text{DMR}}$$

The feedback pulse unit varies according to the type of detector.

$$\text{Feedback pulse unit} = \frac{\text{the amount of travel per rotation of the pulse coder}}{\text{the number of pulses per rotation of the pulse coder (2000, 2500, or 3000)}}$$

As the size of the reference counter, specify the grid interval for the reference position return in the grid method.

Size of the reference counter = Grid interval/detection unit

Grid interval = the amount of travel per rotation of the pulse coder

The value set in the parameter is obtained as follows:

(1) When command multiplier is 1/2 to 1/27

$$\text{Set value} = \frac{1}{(\text{Command multiplier})} + 100$$

Valid data range: 102 to 127

(2) When command multiply is 1 to 48

$$\text{Set value} = 2 \times \text{command multiplier}$$

Valid data range: 2 to 96

NOTE

When command multiplier is 1 to 48, the set value must be determined so that an integer can be set for command multiplier.

1821

Reference counter size for each axis

[Data type] 2-word axis

[Valid data range] 0 to 99999999

Set the size of the reference counter.

NOTE

When this parameter has been set, the power must be turned off before operation is continued.

When using the linear scale with reference marks, set the space between the mark-1 indications.

1825

Servo loop gain for each axis

[Data type] Word axis

[Unit of data] 0.01 s^{-1}

[Valid data range] 1 to 9999

Set the loop gain for position control for each axis.

When the machine performs linear and circular interpolation (cutting), the same value must be set for all axes. When the machine requires positioning only, the values set for the axes may differ from one another.

As the loop gain increases, the response by position control is improved. A too large loop gain, however, makes the servo system unstable.

The relationship between the positioning deviation (the number of pulses counted by the error counter) and the feedrate is expressed as follows:

$$\text{Positioning deviation} = \frac{\text{feedrate}}{60 \times (\text{loop gain})}$$

Unit : Positioning deviation mm, inches, or deg

Feedrate : mm/min, inches/min, or deg/min

loop gain: s⁻¹

1826	In-position width for each axis
------	---------------------------------

[Data type] Word axis

[Unit of data] Detection unit

[Valid data range] 0 to 32767

The in-position width is set for each axis.

When the deviation of the machine position from the specified position (the absolute value of the positioning deviation) is smaller than the in-position width, the machine is assumed to have reached the specified position. (The machine is in the in-position state.)

1827	In-position width in cutting feed for each axis
------	---

[Data type] Word axis

[Unit of data] Detection unit

[Valid data range] 0 to 32767

Set an in-position width for each axis in cutting feed. This parameter is valid when bit 4 (CCI) of parameter No.1801=1.

1828	Positioning deviation limit for each axis in movement
------	---

[Data type] 2-word axis

[Unit of data] Detection unit

[Valid data range] 0 to 99999999

Set the positioning deviation limit in movement for each axis.

If the positioning deviation exceeds the positioning deviation limit during movement, a servo alarm is generated, and operation is stopped immediately (as in emergency stop).

Generally, set the positioning deviation for rapid traverse plus some margin in this parameter.

1829	Positioning deviation limit for each axis in the stopped state
------	--

[Data type] Word axis

[Unit of data] Detection unit

[Valid data range] 0 to 32767

Set the positioning deviation limit in the stopped state for each axis.

If, in the stopped state, the positioning deviation exceeds the positioning deviation limit set for stopped state, a servo alarm is generated, and operation is stopped immediately (as in emergency stop).

1830

Axis-by-axis positional deviation limit at servo-off time

[Data type] 2-word axis**[Unit of data]** Detection unit**[Valid data range]** 0 to 99999999

This parameter is used to set a positional deviation limit at servo-off time, on an axis-by-axis basis.

If the value specified with this parameter is exceeded at servo-off time, a servo alarm (No.410) is issued to cause an immediate stop (same as an emergency stop). Usually, set the same value as a positional deviation at stop time (parameter No.1829).

NOTE

When this parameter is set to 0, no positional deviation limit check is made at servo-off time.

1832

Feed stop positioning deviation for each axis

[Data type] 2-word axis**[Unit of data]** Detection unit**[Valid data range]** 0 to 99999999

Set the feed stop positioning deviation for each axis.

If the positioning deviation exceeds the feed stop positioning deviation during movement, pulse distribution and acceleration/deceleration control are stopped temporarily. When the positioning deviation drops to the feed stop positioning deviation or below, pulse distribution and acceleration/deceleration control are resumed.

The feed stop function is used to reduce overshoot in acceleration/deceleration mainly by large servo motors.

Generally, set the middle value between the positioning deviation limit during movement and the positioning deviation at rapid traverse as the feed stop positioning deviation.

NOTE

If the parameter is set to 0, the feed stop function is disabled.

1836

Servo error amount where reference position return is possible

[Data type] Byte axis**[Unit of data]** Detection unit**[Valid data range]** 0 to 127

This parameter sets a servo error used to enable reference position return in manual reference position return.

In general, set this parameter to 0. (When 0 is set, 128 is assumed as the default.)

NOTE

When bit 0 (PLC01) of parameter No.2000 is set to 1, a value ten times greater than the value set in this parameter is used to make the check.

Example

When the value 10 is set in this parameter, and bit 0 (PLC01) of parameter No.2000 is set to 1, reference

1838

Limit of position deviation during movement in the safety signal mode C for each axis

[Data type] 2–word axis

[Unit of data] Detection unit

[Valid data range] 0 to 99999999

Set a limit of position deviation during movement in the safety signal mode C (a guard open request is input, and the guard is open) for each axis while the dual check safety function is used.

If a position deviation during a movement exceeds the limit of position deviation during movement, a servo alarm is raised, and an immediate stop (same as emergency stop) is made.

With the dual check safety function, the CNC and monitor check the position deviation in the safety signal mode C (a guard open request is input, and the guard is open). Otherwise, just the CNC checks the position deviation.

While the guard is open, axial movements are made at a speed within the range of safety speed, so that a value smaller than the limit of position deviation during movement (parameter No. 1828) is set.

1850

Grid shift and reference position shift for each axis

NOTE

When this parameter has been set, the power must be turned off before operation is continued.

[Data type] 2–word axis

[Unit of data] Detection unit

[Valid data range] 0 to 99999999 (for reference position shift)

Reference counter size or less (for grid shift)

To shift the reference position, the grid can be shifted by the amount set in this parameter. Up to the maximum value counted by the reference counter can be specified as the grid shift.

In case of parameter SFD (No.1002#2) is 0: Grid shift

In case of parameter SFD (No.1002#2) is 1: Reference point shift

1851	Backlash compensating value for each axis
------	---

[Data type] Word axis

[Unit of data] Detection unit

[Valid data range] -9999 to +9999

Set the backlash compensating value for each axis.

When the machine moves in a direction opposite to the reference position return direction after the power is turned on, the first backlash compensation is performed.

1852	Backlash compensating value used for rapid traverse for each axis
------	---

[Data type] Word axis

[Unit of data] Detection unit

[Valid data range] -9999 to +9999

Set the backlash compensating value used in rapid traverse for each axis.

This parameter is valid when RBK, #4 of parameter 1800, is set to 1.

More precise machining can be performed by changing the backlash compensating value depending on the feedrate, the rapid traverse or the cutting feed.

Let the measured backlash at cutting feed be A and the measured backlash at rapid traverse be B. The backlash compensating value is shown below depending on the change of feedrate (cutting feed or rapid traverse) and the change of the direction of movement.

Table 4.18 Backlash Compensating Value

Change of feedrate Change of direction of movement	Cutting feed to cutting feed	Rapid traverse to rapid traverse	Rapid traverse to cutting feed	Cutting feed to rapid traverse
Same direction	0	0	$\pm\alpha$	$\pm(-\alpha)$
Opposite direction	$\pm A$	$\pm B$	$\pm B (B+\alpha)$	$\pm B (B+\alpha)$

$$\alpha = (A-B)/2$$

The positive or negative direction for compensating values is the direction of movement.

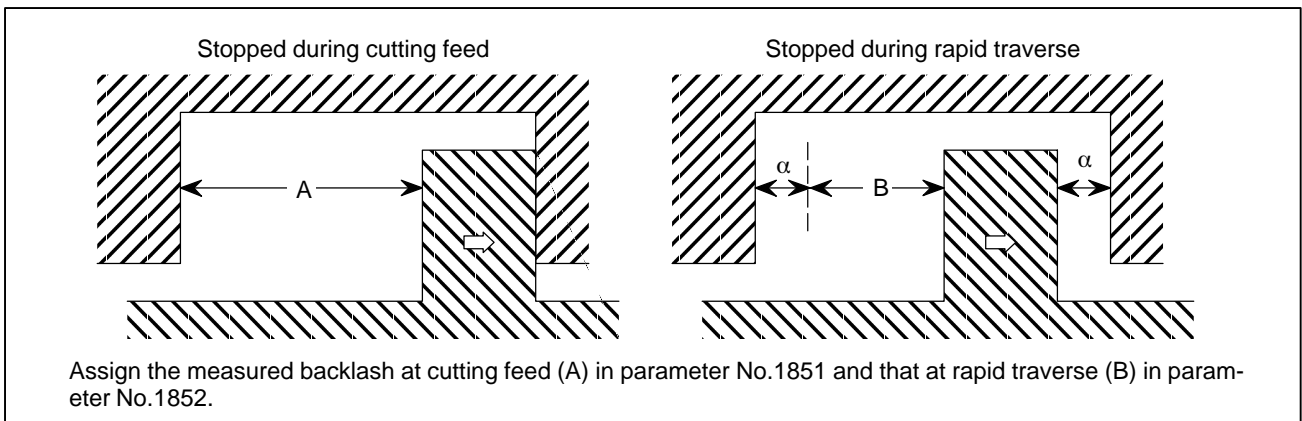

NOTE

- 1 Jog feed is regarded as cutting feed.
- 2 The backlash compensation depending on a rapid traverse and a cutting feed is not performed until the first reference position return is completed after the power is turned on. The normal backlash compensation is performed according to the value specified in parameter No.1851 irrespective of a rapid traverse and a cutting feed.
- 3 The backlash compensation depending on a rapid traverse and a cutting feed is performed only when RBK, #4 of parameter No.1800, is set to 1. When RBK is set to 0, the normal backlash is performed.

1870

Number of the program for storing servo trace data

[Data type] Word axis**[Valid data range]** 0 to 9999

Set the number of the program for storing servo trace data.

1871

Program number where servo trace data is stored (when the program number is 8 digits)

[Data type] 2-word axis**[Valid data range]** 0 to 99999999

Set a program number where servo trace data is to be stored, when the program number is 8 digits.

NOTE

Do not use parameter No.1870, which is dedicated to the standard function (4-digit O number).

1874

Number of the conversion coefficient for inductosyn position detection

1875

Denominator of the conversion coefficient for inductosyn position detection

NOTE

When this parameter has been set, the power must be turned off before operation is continued.

[Data type] Word axis**[Valid data range]** 1 to 32767

Set a conversion coefficient for inductosyn position detection for each axis. The value set is determined as follows:

No. 1874	Number of position feedback pulses per motor revolution
No. 1875	1,000,000

1876

One-pitch interval of the inductosyn

NOTE

When this parameter has been set, the power must be turned off before operation is continued.

[Data type] Word axis

[Unit of data] Detection unit

[Valid data range] 1 to 32767

Set a one-pitch interval of the inductosyn for each axis.

SUPPLEMENTAL REMARK

To use an absolute-position detector using Inductosyn, set the following digital servo parameters as well:

Bit 4 (INDx) of parameter No. 2015

The absolute-position detect function by Inductosyn is:

0 : Disabled.

1 : Enabled.

Parameter No. 2141 Inductosyn data acquisition time

Set a time requirement for acquiring the Inductosyn data. If the setting is 0, 20 ms is assumed. (For the setting, contact the scale manufacturer.)

1880

Abnormal load detection alarm timer

[Data type] Word axis

[Unit of data] ms

[Valid data range] 0 to 32767 (200 msec is assumed when 0 is set)

This parameter sets the time from the detection of an abnormal load until a servo alarm is issued. The specified value is rounded up to the nearest integral multiple of 8 msec.

[Example] When 30 is specified, the value is rounded up to 32 (msec).

1881

Group number when an abnormal load is detected

[Data type] Byte axis

[Valid data range] 0 to 8

This parameter sets the group number of each axis, used when an abnormal load is detected.

If an abnormal load is detected for an axis, only the movement along the axes of the group containing the axis with the abnormal load is stopped. If 0 is set for an axis, movement along that axis is stopped whenever an abnormal load is detected for any axis.

Example: Assume that the following settings have been made. If an abnormal load is detected for the sixth axis, movement along the second, fourth, sixth, and seventh axes is stopped. If an abnormal load is detected for the fourth axis, movement along the fourth and seventh axes is stopped.

Parameter No.1881	Setting
(First axis)	1
(Second axis)	2
(Third axis)	1
(Fourth axis)	0
(Fifth axis)	3
(Sixth axis)	2
(Seventh axis)	0

NOTE

This parameter is enabled when the ANA parameter (bit 5 of parameter No.1804) is 1.

1882

Space between the mark-2 indications on the linear scale with reference marks

NOTE

After this parameter has been set, the power must be turned off then back on for the setting to become effective.

[Data type] 2-word axis

[Unit of data] Detection unit

[Valid data range] 0 to 99999999

This parameter sets the space between the mark-2 indications on the linear scale with reference marks.

1883

Distance from the zero point of the linear scale with reference marks to the reference position

NOTE

After this parameter has been set, the power must be turned off then back on for the setting to become effective.

[Data type] 2-word axis

[Unit of data] Detection unit

[Valid data range] -99999999 to 99999999

This parameter sets the distance from the zero point of the linear scale with reference marks to the reference position. The zero point of the scale is that point where mark 1 and mark 2 match. Generally, this point is a virtual point that does not actually exist on the scale. (See the figure below.)

When the reference position is located in the positive direction as viewed from the zero point of the scale, set a positive value for this parameter. When the reference position is located in the negative direction as viewed from the zero point, set a negative value.

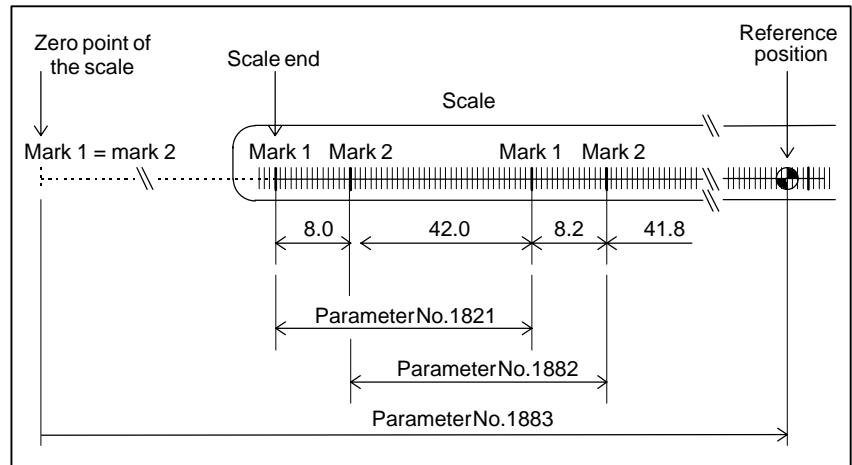

1884	Distance 2 from the zero point of the linear scale with absolute addressing reference marks to the reference position
------	---

NOTE
 After this parameter is set, the power must be turned off then back on for the setting to become effective.

[Data type] Word axis

[Unit of data] Detection unit \times 100,000,000

[Valid data range] -20 to 20

Set the distance from the scale zero point to the reference position. The reference position is set according to parameter No. 1883 and this parameter. This parameter is used if the distance from the scale zero point to the reference position is beyond the setting range of parameter No. 1883.

1885	Maximum allowable value for total travel during torque control
------	--

[Data type] Word axis

[Unit of data] Detection unit

[Valid data range] 0 to 32767

This parameter sets the maximum allowable value for the total travel (error counter value) for an axis placed under torque control, as specified by the axis control command of the PMC axis control function. If the total travel exceeds the parameter-set value while torque control is applied, a servo alarm (No.423) is generated.

NOTE
 This parameter is enabled when the TQF parameter (bit 4 of parameter No.1803) is 0 (follow-up is not performed during torque control).

1886

Positional deviation when torque control is canceled

[Data type] Word axis**[Unit of data]** Detection unit**[Valid data range]** 0 to 32767

This parameter sets the positional deviation used when torque control, performed for an axis according to the axis control command of the PMC axis control function, is canceled and position control is resumed. After the positional deviation has fallen to the parameter-set value, switching to position control is performed.

NOTE

This parameter is enabled when the TQF parameter (bit 4 of parameter No.1803) is 0 (follow-up is not performed during torque control).

1890

Servo motor speed for detection

NOTE

When this parameter has been set, the power must be turned off before operation is continued.

[Data type] Word axis**[Unit of data]** min^{-1} **[Valid data range]** 0 to 8000

The servo motor speed of each axis is monitored and a motor speed detection signal is output indicating whether the speed of each axis exceeds the value set in this parameter (set in the Y address specified in parameter No.1891)

NOTE

No motor speed detection signals are output when the servo/spindle motor speed detection function is not used or 0 is set in this parameter.

1891

Initial value of the Y address where motor speed detection signals are output

NOTE

When this parameter has been set, the power must be turned off before operation is continued.

[Data type] Word axis**[Valid data range]** 0 to 126, 1000 to 1013, 1020 to 1033

This parameter specifies the Y address where motor speed detection signals are output.

The spindle motor speeds and servo motor speed of each axis are monitored and motor speed detection signals are output to the Y address specified in this parameter and (Y address +1) to indicate whether speeds exceed the values set in the parameters.

- Y address n :Servo motor speed detection signals are output.
(See the description of parameter No.1890.)
- Y address n+1 :Spindle motor speed detection signals are output.
(See the description of parameter No.4345.)

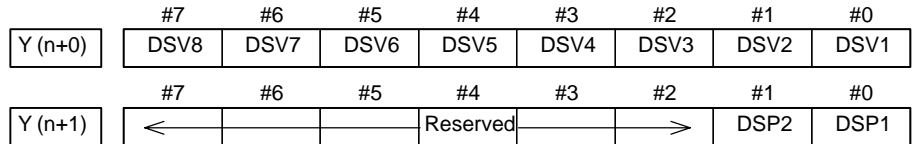

n : setting value

DSV1-DSV8 : Motor speed detection signals of servo motors for axis 1 to axis 8
 DSP1, DSP2 : Motor speed detection signals of the first and second serial spindles

NOTE

- 1 No motor speed detection signals are output when the servo/spindle motor speed detection function is not used, the value 0 or a value beyond the allowable data range is specified in this parameter, or an input/output address specified within the allowable data range represents an address where no I/O device is mounted.
- 2 Be sure to specify a Y address that is not used with a PMC sequence program (ladder).
- 3 When controlling two path lathe, ensure that the same value is not set for 1 path lathe and 2 path lathe . (Set a separate address for 1 path lathe and 2 path lathe.)

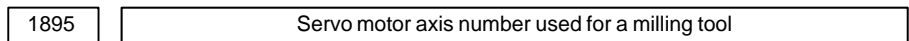

[Data type] Byte

[Valid data range] 1, 2, 3, ..., number of controlled axes

This parameter sets the servo motor axis number used for displaying the speed of a milling tool that incorporates a servo motor.

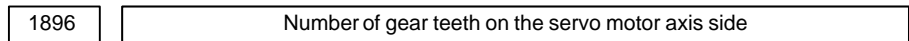

[Data type] Word

[Valid data range] 1 to 9999

This parameter sets the number of servo motor axis gear teeth used for displaying the speed of a milling tool that incorporates a servo motor.

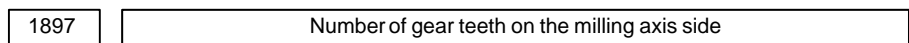

[Data type] Word

[Valid data range] 1 to 9999

This parameter sets the number of milling axis gear teeth used for displaying the speed of a milling tool that incorporates a servo motor.

	#7	#6	#5	#4	#3	#2	#1	#0
1902		DCE			STP		ASE	FMD

NOTE

After this parameter has been set, the power must be turned off then back on for the setting to become effective.

[Data type] Bit

- FMD** The FSSB setting mode is:
 0 : Automatic setting mode.
 (When information including an axis–amplifier relationship is set on the FSSB setting screen, parameter Nos. 1023, 1905, 1910 through 1919, 1936, and 1937 are set automatically.)
 1 : Manual setting 2 mode.
 (Set parameter Nos. 1023, 1905, 1910 through 1919, 1936, and 1937 manually.)
- ASE** When automatic setting mode is selected for FSSB setting (when the FMD parameter (bit 0 of parameter No.1902) is set to 0), automatic setting is:
 0 : Not completed.
 1 : Completed.
 (This bit is automatically set to 1 upon the completion of automatic setting.)
- STP** With the dual check safety function, in the self test mode at power–up, a self test of safety output signal is:
 0 : Performed. (At power–up, the “CARRY OUT A SAFETY TEST” warning appears, and the self test execution request signal RQT is output.)
 1 : Not performed.

CAUTION

- 1 The STP bit is temporarily used if an MCC shut–off test of safety output signal in the MCC shut–off test mode is not wanted at power–up when the machine is adjusted, for instance.
- 2 Even if STP is set to 1, an MCC shut–off test of safety output signal in the MCC shut–off test mode is required when the power is turned on after 24 hours have elapsed since the completion of the previous MCC shut–off test.

WARNING

If STP is temporarily set to 1 for machine adjustment or the like, reset STP to 0.

- DCE** The dual check safety function is:
 0 : Disabled.
 1 : Enabled.

CAUTION

For a machine using the dual check safety function, usually set DCE to 1. If DCE is 0, the MCC on enable signal MCF will not be brought to 1 (MCC on enabled), and the machine will not be activated.

WARNING

Always set the bits other than FMD, ASE, STP, and DCE of parameter No. 1902 to 0. If 1 is set in any of those bits, the safety function may not normally work.

	#7	#6	#5	#4	#3	#2	#1	#0
1904								DSP

NOTE

After this parameter has been set, the power must be turned off then back on for the setting to become effective.

[Data type] Bit axis

DSP

- 0 : Two axes use one DSP. (Ordinary axes)
- 1 : One axis uses one DSP. (Axes such as a learning control axis)

NOTE

Parameter No.1904 is set on the FSSB setting screen. So, parameter No.1904 should not have to be specified directly. This parameter need not be set in FSSB manual setting 2 mode.

	#7	#6	#5	#4	#3	#2	#1	#0
1905	PM2	PM1	IO2	IO1				FSL

NOTE

After this parameter has been set, the power must be turned off then back on for the setting to become effective.

[Data type] Bit axis

- FSL** The type of interface used between the servo amplifier and servo software is:
- 0 : Fast type.
 - 1 : Slow type.

The user can choose between two interface types for servo data transfer: fast type or slow type. Set this parameter so that the following conditions are satisfied:

- When a one-axis amplifier is used, either the fast type or slow type interface can be used.
- When a two-axis amplifier is used, the use of the fast type for both axes is not allowed. The slow type can be used for both axes.

- When a three-axis amplifier is used, the requirement for a two-axes amplifier described above applies to the first and second axes, and the requirement for a one-axis amplifier, again described above, applies to the third axis.
- When an odd number is specified for parameter No.1023, the fast type interface must be used. However, the slow type may be used for an EGB workpiece axis, learning control axis, high-speed current loop axis, and high-speed interface axis.
- When an even number is specified for parameter No.1023, only the slow type interface can be used. (The FSL bit must always be set to 1.)

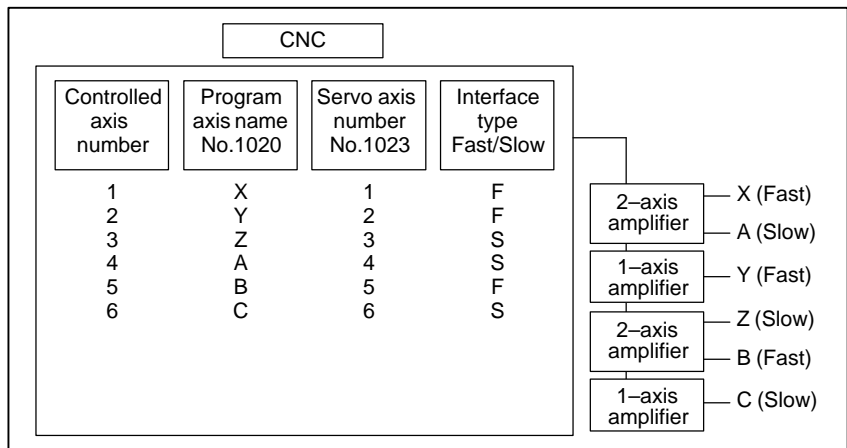

IO1 A first I/O module supporting FSSB is:

- 0 : Not used.
- 1 Used.

IO2 A second I/O module supporting FSSB is:

- 0 : Not used.
- 1 Used.

PM1 The first pulse module is:

- 0 : Not used.
- 1 : Used.

PM2 The second pulse module is:

- 0 : Not used.
- 1 : Used.

NOTE

When automatic setting mode is selected for FSSB setting (when the FMD parameter (bit 0 of parameter No.1902) is set to 0), parameter No.1905 is automatically set when input is performed with the FSSB setting screen. When manual setting 2 mode is selected for FSSB setting (when the FMD parameter (bit 0 of parameter No.1902) is set to 1), parameter No.1905 must be set directly. When a pulse module is used, a connector number must be set in the corresponding parameter (No.1936 or No.1937).

1910	Address conversion table value for slave 1 (ATR)
1911	Address conversion table value for slave 2 (ATR)
1912	Address conversion table value for slave 3 (ATR)
1913	Address conversion table value for slave 4 (ATR)
1914	Address conversion table value for slave 5 (ATR)
1915	Address conversion table value for slave 6 (ATR)
1916	Address conversion table value for slave 7 (ATR)
1917	Address conversion table value for slave 8 (ATR)
1918	Address conversion table value for slave 9 (ATR)
1919	Address conversion table value for slave 10 (ATR)

NOTE

After these parameters have been set, the power must be turned off then back on for the settings to become effective.

[Data type] Byte

[Valid data range] 0 to 7, 16, 40, 48

These parameters set address conversion table values for slaves 1 to 10. A slave is the generic name given to a device such as a servo amplifier or pulse module, connected to the CNC via an FSSB optical cable. Smaller numbers, starting from 1 are assigned to slaves closer to the CNC; the maximum number that can be assigned is 10. A two-axis amplifier has two slaves, while a three-axis amplifier has three slaves. Set each parameter as described below, depending on whether the slave is an amplifier or pulse module, or when no slave exists.

- When the slave is an amplifier:
Set the value obtained by subtracting 1 from the setting of parameter No.1023 for the axis to which the amplifier is assigned.
- When the slave is a pulse module:
Set 16 for the first pulse module (closest to the CNC). Set 48 for the second pulse module (furthest from the CNC).
- When no slave exists
Set 40. When using the simple electronic gearbox (EGB) function, however, set a value as described below.

NOTE

1 When using the simple electronic gearbox (EGB) function

The EGB axis (axis set with parameter No.7771) does not actually require an amplifier. So, assume that the EGB axis is connected to a dummy amplifier. Accordingly, as the address conversion table value for a nonexistent slave, set the value obtained by subtracting 1 from the setting made for parameter No.1023 for the EGB axis, instead of setting 40.

2 When automatic setting mode is selected for FSSB setting (when the FMD parameter (bit 0 of parameter No.1902) is set to 0), parameters No.1910 through No.1919 are automatically set when input is performed with the FSSB setting screen. When manual setting 2 mode is selected for FSSB setting (when the FMD parameter (bit 0 of parameter No.1902) is set to 1), parameter No.1910 through No.1919 must be directly set.

• Examples of axis configurations and parameter settings

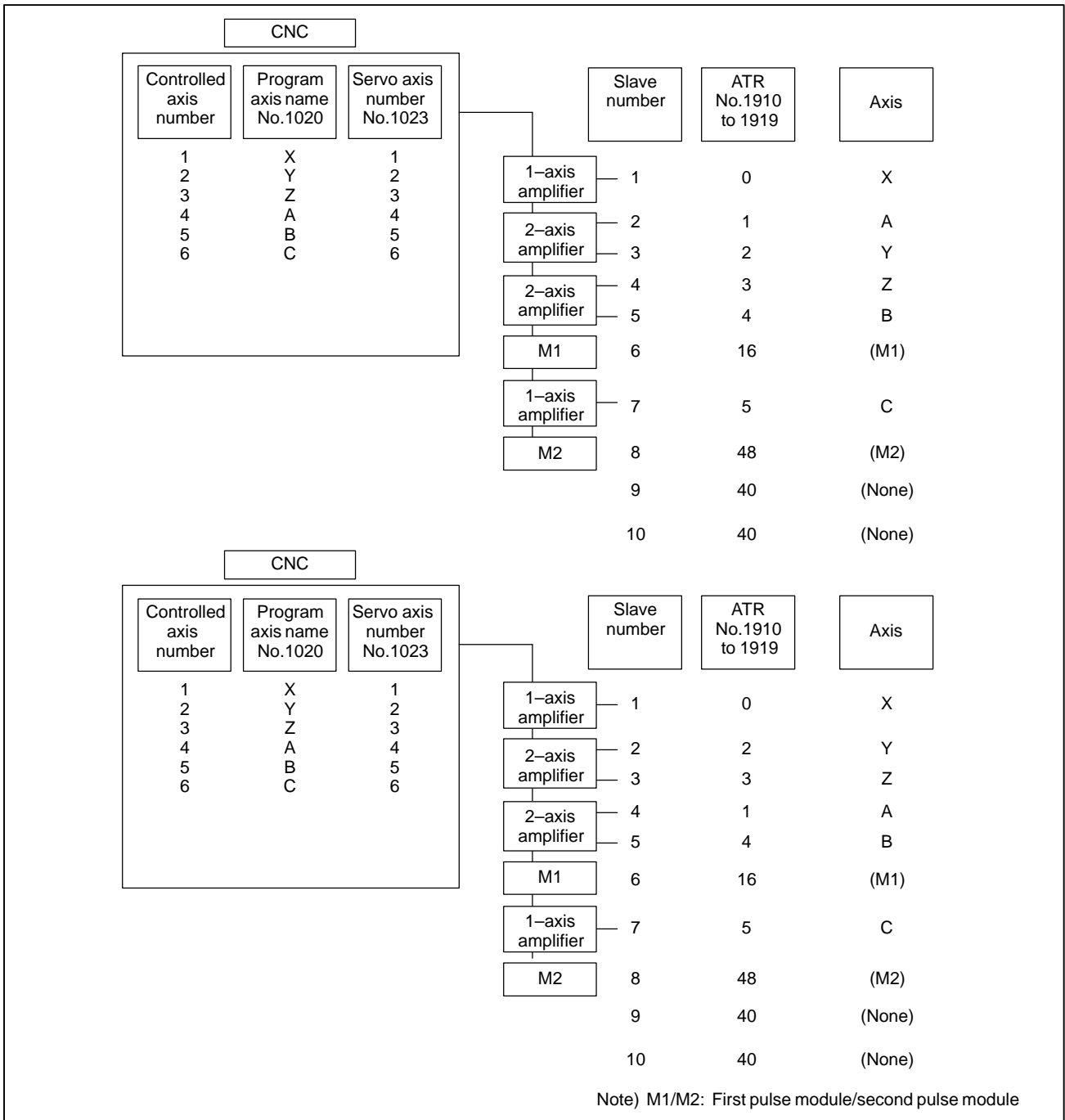

- Example of axis configuration and parameter settings when the simple electronic gearbox (EGB) function is used (EGB workpiece axes: A axis, EGB axis, B axis (Parameter No.7771=5))

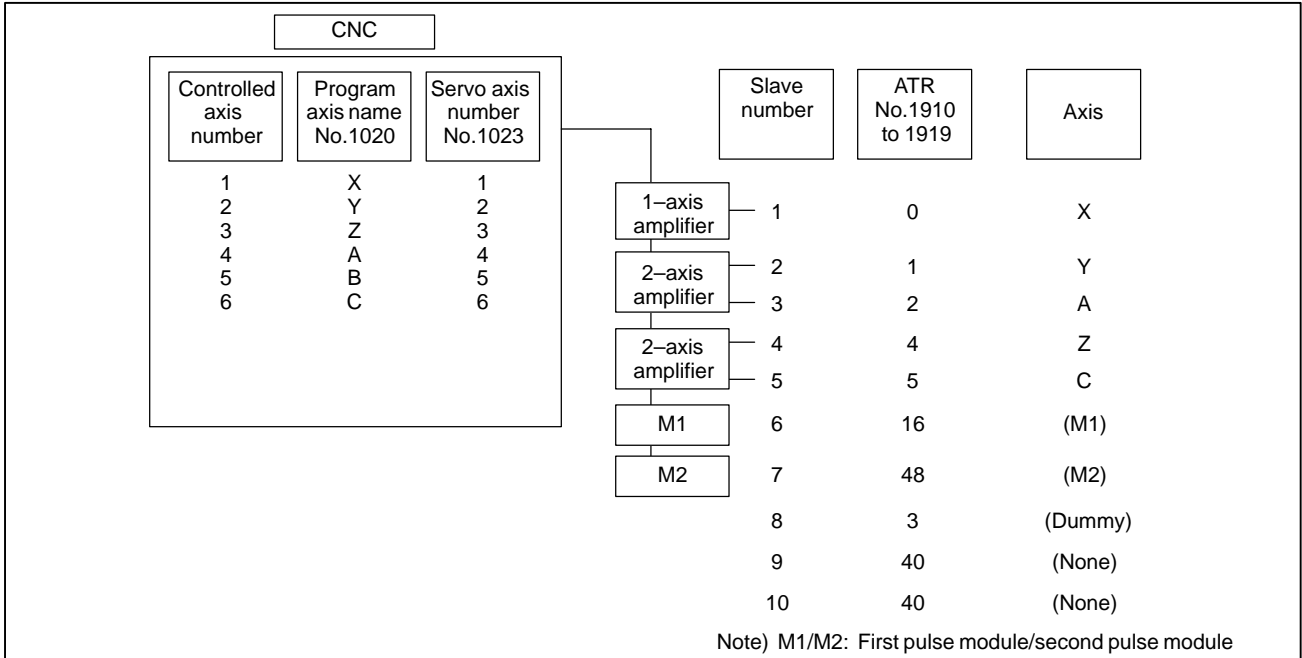

1920	Controlled axis number for slave 1 (dedicated to the FSSB setting screen)
1921	Controlled axis number for slave 2 (dedicated to the FSSB setting screen)
1922	Controlled axis number for slave 3 (dedicated to the FSSB setting screen)
1923	Controlled axis number for slave 4 (dedicated to the FSSB setting screen)
1924	Controlled axis number for slave 5 (dedicated to the FSSB setting screen)
1925	Controlled axis number for slave 6 (dedicated to the FSSB setting screen)
1926	Controlled axis number for slave 7 (dedicated to the FSSB setting screen)
1927	Controlled axis number for slave 8 (dedicated to the FSSB setting screen)
1928	Controlled axis number for slave 9 (dedicated to the FSSB setting screen)
1929	Controlled axis number for slave 10 (dedicated to the FSSB setting screen)

NOTE

After these parameters have been set, the power must be turned off then back on for the settings to become effective.

[Data type] Byte

[Valid data range] 0 to 8

These parameters are used to set the controlled axis numbers for slaves 1 to 10.

NOTE

These parameters are set using the FSSB setting screen. So, these parameters should not normally have to be specified directly. These parameters need not be set in FSSB manual setting mode.

1931	Connector number for the first pulse module (dedicated to the FSSB setting screen)
1932	Connector number for the second pulse module (dedicated to the FSSB setting screen)

NOTE

After these parameters have been set, the power must be turned off then back on for the settings to become effective.

[Data type] Byte axis

[Valid data range] 0 to number of connectors provided on each pulse module

When a pulse module is used, these parameters set a pulse module connector number for each axis.

NOTE

These parameters are set using the FSSB setting screen. So, these parameters should not normally have to be specified directly. These parameters need not be set in FSSB manual setting 2 mode.

1933	Cs contour control axis (dedicated to the FSSB setting screen)
------	--

NOTE

After this parameter has been set, the power must be turned off then back on for the setting to become effective.

[Data type] Byte axis

[Valid data range] 0, 1

When Cs contour control is to be applied for an axis, this parameter must be set to 1 for that axis.

NOTE

This parameter is set using the FSSB setting screen. So, this parameter should not normally have to be specified directly. This parameter need not be set in FSSB manual setting 2 mode.

1934	Master and slave axis numbers subject to tandem control (dedicated to the FSSB setting screen)
------	--

NOTE

After this parameter has been set, the power must be turned off then back on for the setting to become effective.

[Data type] Byte axis

[Valid data range] 0 to 8

This parameter is used to set an odd number, and the subsequent even number, for a master axis and slave axis subject to tandem control, respectively.

NOTE

This parameter is set using the FSSB setting screen. So, this parameter should not normally have to be specified directly. This parameter need not be set in FSSB manual setting 2 mode.

1936	Connector number of the first pulse module
1937	Connector number of the second pulse module

NOTE

After these parameters have been set, the power must be turned off then back on for the settings to become effective.

[Data type] Byte axis

[Valid data range] 0 to 7

When a pulse module is used, each of these parameters sets the value obtained by subtracting 1 from a pulse module connector number for each axis. That is, values of 0 through 7 are set for connector numbers 1 through 8. In addition, bits 6 and 7 of parameter No.1905 must be set. For an axis that does not use a pulse module, 0 must be set.

Any connector can be used for any axis, however the connectors in a single pulse module should be used in ascending order of connector number. For instance, connector 4 of a pulse module cannot be used without using connector 3 of the same pulse module.

Example:

Controlled axis	Connector number for the first pulse module	Connector number for the second pulse module	No.1936	No.1937	No.1905 (#7, #6)
X	1	Not used	0	0	0,1
Y	Not used	2	0	1	1,0
Z	Not used	1	0	0	1,0
A	Not used	Not used	0	0	0,0
B	2	Not used	1	0	0,1
C	Not used	3	0	2	1,0

NOTE

When automatic setting mode is selected for FSSB setting (when bit 0 of parameter No.1902 is set to 0), these parameters are automatically set when input is performed with the FSSB setting screen. When manual setting 2 mode is selected for FSSB setting (when bit 0 of parameter No.1902 is set to 1), these parameters must be set directly.

1942	Safety speed of each axis for dual check safety function
------	--

NOTE

When this parameter has been set, the power must be turned off before operation is continued.

[Data type] 2-word axis

[Unit of data, Valid data range]

Increment system	Unit of data	Valid data range	
		IS-A, IS-B	IS-C
Metric machine	1 mm/min	0 to 240,000	0 to 100,000
Inch machine	0.1 inch/min	0 to 96,000	0 to 48,000
Rotation axis	1 deg/min	0 to 240,000	0 to 100,000

Set the safety speed of each axis.

In the safety signal mode B (a guard open request is input, and the guard is closed) with the dual check safety function, the CNC and monitor check the velocity command of each axis. If a velocity command exceeding the range of safety speed is found on a single axis at least, the guard unlock enable signal *LGD is set to 0 so that the guard will not be unlocked. A single condition for setting the guard unlock enable signal *LGD to 1 (enabling guard unlock) is that the velocity commands for all the axes are within the range of safety speed.

In the safety signal mode C (a guard open request is input, and the guard is open), the CNC and monitor check the velocity command of each axis. If a velocity command exceeding the range of safety speed is found on a single axis at least, a servo alarm is raised.

1943	Safety position (positive direction) of each axis for dual check safety function
------	--

1944	Safety position (negative direction) of each axis for dual check safety function
------	--

NOTE

When this parameter has been set, the power must be turned off before operation is continued.

[Data type] 2-word axis

[Unit of data]

Increment system	IS-A	IS-B	IS-C	Unit
Linear axis (millimeter input)	0.01	0.001	0.0001	mm
Linear axis (inch input)	0.001	0.0001	0.00001	inch
Rotation axis	0.01	0.001	0.0001	deg

[Valid data range] -99999999 to 99999999

Set the safety position of each axis.

In the safety signal mode B (a guard open request is input, and the guard is closed) with the dual check safety function, the CNC and monitor check the machine position on each linear axis. If a machine position on a single linear axis at least is beyond the safety position range (safety position (negative direction) \leq machine position \leq safety position (positive direction)), the guard unlock enable signal *LGD is set to 0 so that the guard will not be unlocked. One condition for setting the guard unlock enable signal *LGD to 1 (enabling guard unlock) is that the machine position is within the safety position range on all linear axes.

In the safety signal mode C (a guard open request is input, and the guard is open), the CNC and monitor check the machine position on each linear axis. If the machine position on at least one linear axis is beyond the safety position range, a servo alarm is raised.

NOTE

A machine position check is carried out on a linear axis. A machine position check is not performed on a rotation axis. A machine position check is carried out on an axis on which the reference position is established. A machine position check is not performed on an axis on which the reference position is not established.

1945

Safety input signal check timer for dual check safety function

NOTE

When this parameter has been set, the power must be turned off before operation is continued.

[Data type] Word

[Unit of data] ms

[Valid data range] 0 to 32767

An input signal related to dual check safety (safety input signal) can be input through the PMC to the CNC or through FSSB to the monitor. The CNC and monitor continuously exchange their input signals and monitor each other. If a difference exceeding the time of the safety input signal check timer is found between the signals input through the two paths, a servo alarm is raised. If 16 or a smaller value is set, 16 ms is assumed.

1946

MCC shut-off test timer for dual check safety function

NOTE

When this parameter has been set, the power must be turned off before operation is continued.

[Data type] Word

[Unit of data] ms

[Valid data range] 0 to 32767

In the MCC shut-off test mode with the dual check safety function, the CNC executes an MCC shut-off test of safety output signal. If the MCC shut-off test is not completed within the time of the MCC shut-off test timer, a servo alarm is raised. If the setting is 0 or smaller, 10000 ms is assumed.

1947	MCC off timer 1 for dual check safety function
1948	MCC off timer 2 for dual check safety function

NOTE

After this parameter is set, the power must be turned off then back on for the setting to become effective.

[Data type] Word

[Unit of data] ms

[Valid data range] 0 to 32767

If the MCC on enable signal MCF has to be set to 0 (MCC turned off) by an alarm or emergency stop, with the dual check safety function, the CNC and monitor bring the MCC on enable signal (MCF) to 0 when the time of MCC off timer has elapsed after the occurrence of alarm or emergency stop.

If a spindle alarm is raised, the timer is not used. The MCC on enable signal MCF is immediately set to 0.

If the MCC is shut off while the spindle motor is rotating, the spindle motor enters the freewheeling state, then stops (after a certain period of time). If the spindle motor has to be stopped quickly, use this parameter to stop the spindle motor and then shut off the MCC.

State	Timer used
Spindle alarm raised	The timer is not used.
Guard closed	MCC off timer 1 (No. 1947)
Guard open	MCC off timer 2 (No. 1948)

1970	Value of address translation table corresponding to slave 1 of the second path (ATR)
1971	Value of address translation table corresponding to slave 2 of the second path (ATR)
1972	Value of address translation table corresponding to slave 3 of the second path (ATR)
1973	Value of address translation table corresponding to slave 4 of the second path (ATR)
1974	Value of address translation table corresponding to slave 5 of the second path (ATR)
1975	Value of address translation table corresponding to slave 6 of the second path (ATR)
1976	Value of address translation table corresponding to slave 7 of the second path (ATR)
1977	Value of address translation table corresponding to slave 8 of the second path (ATR)
1978	Value of address translation table corresponding to slave 9 of the second path (ATR)
1979	Value of address translation table corresponding to slave 10 of the second path (ATR)

NOTE

When this parameter has been set, the power must be turned off before operation is continued.

[Data type] Byte

[Valid data range] 0 to 7, 16, 40, 48

Set the values of address translation table corresponding to slaves 1 to 10 of the second path. The settings are the same as those of the first path (parameters No. 1910 to No. 1919).

Parameters No.2000 to 2999 are for digital servo, The following parameters are not explained in this manual. Refer to FANUC AC SERVO MOTOR α series PARAMETER MANUAL (B-65150E)

No.	Data type	Contents							
2000	Bit axis				PGEX	PRMC		DGPR	PLC0
2001	Bit axis	AMR7	AMR6	AMR5	AMR4	AMR3	AMR2	AMR1	AMR0
2002	Bit axis	VFSE				PFSE			
2003	Bit axis	V0FS	OVSC	BLEN	NPSP	PIEN	OBEN	TGAL	
2004	Bit axis		DLY0			TRW1	TRW0	TIB0	TIA0
2005	Bit axis	SFCM	BRKC					FEED	
2006	Bit axis		DCBE		ACCF	SPVE	PKVE	SBSM	FCBL
2007	Bit axis	FRCA	FAD						
2008	Bit axis	LAXD	PFBS	VCTM	SPPC	SPPR	VFBA	TNDM	
2009	Bit axis	BLST	BLCU				ADBL	IQOB	SERD
2010	Bit axis	POLE		HBBL	HBPE	BLTE	LINE		
2011	Bit axis			RCCL				FFALWY	SYNMOD
2012	Bit axis	STNG		VCM2	VCM1			MSFE	
2013	Bit axis	APTG							
2014	Bit axis	(Reserve)							
2015	Bit axis	BZNG	BLAT	TDOU				SSG1	PGTW
2016	Bit axis					K2VC			ABNT
2017	Bit axis	PK25	OVCR	RISC	HTNG				DBST
2018	Bit axis	PFBC						MOVO	REVS
2019	Bit axis	DPFB			SPSY				
2020	Word axis	Motor number							
2021	Word axis	Load inertia ratio							
2022	Word axis	Direction of motor rotation							
2023	Word axis	Number of velocity pulses							
2024	Word axis	Number of position pulses							
2028	Word axis	Position gain switching speed							
2029	Word axis	Effective speed for integral acceleration at low speed							
2030	Word axis	Effective speed for integral deceleration at low speed							
2033	Word axis	Position feedback pulse							
2034	Word axis	Damping control gain							
2039	Word axis	Second-stage acceleration for two-stage backlash acceleration							
2040	Word axis	Current loop integral gain (PK1)							
2041	Word axis	Current loop proportional gain (PK2)							
2042	Word axis	Current loop gain (PK3)							
2043	Word axis	Velocity loop integral gain (PK1V)							
2044	Word axis	Velocity loop proportional gain (PK2V)							
2045	Word axis	Velocity loop incomplete integral gain (PK3V)							
2046	Word axis	Velocity loop gain (PK4V)							
2047	Word axis	Observer parameter (POA1)							
2048	Word axis	Backlash acceleration							
2049	Word axis	Maximum amplitude for dual position feedback							
2050	Word axis	Observer parameter (POK1)							
2051	Word axis	Observer parameter (POK2)							
2053	Word axis	Current dead zone compensation (PPMAX)							
2054	Word axis	Current dead zone compensation (PDDP)							
2055	Word axis	Current dead zone compensation (PHYST)							
2056	Word axis	Counterelectromotive force compensation (EMFCMP)							
2057	Word axis	Current phase lead compensation (PVPA)							
2058	Word axis	Current phase lead compensation (PALPH)							
2059	Word axis	Counterelectromotive force compensation (EMFBAS)							
2060	Word axis	Torque limit							

No.	Data type	Contents
2061	Word axis	Counterelectromotive force compensation (EMFLMT)
2062	Word axis	Overload protection coefficient (OVC1)
2063	Word axis	Overload protection coefficient (OVC2)
2064	Word axis	Soft disconnection alarm level
2065	Word axis	Overload protection coefficient (OCVLMT)
2066	Word axis	250- μ s acceleration feedback
2067	Word axis	Torque command filter
2068	Word axis	Feed forward coefficient
2069	Word axis	Velocity feed forward coefficient
2070	Word axis	Backlash acceleration timing
2071	Word axis	Backlash acceleration effective duration
2072	Word axis	Static friction compensation
2073	Word axis	Stop judgment parameter
2074	Word axis	Velocity-dependent current loop gain
2077	Word axis	Overshoot prevention counter
2078	Word axis	Conversion coefficient for dual position feedback (numerator)
2079	Word axis	Conversion coefficient for dual position feedback (denominator)
2080	Word axis	First-order lag time constant for dual position feedback
2081	Word axis	Zero width for dual position feedback
2082	Word axis	Backlash acceleration stop amount
2083	Word axis	Brake control timer (ms)
2084	Word axis	Flexible feed gear (numerator)
2085	Word axis	Flexible feed gear (denominator)
2086	Word axis	Rated current parameter
2087	Word axis	Torque offset
2088	Word axis	Machine velocity feedback coefficient gain
2089	Word axis	Backlash acceleration base pulse
2091	Word axis	Non-linear control parameter
2092	Word axis	Look-ahead feed forward coefficient
2097	Word axis	Static friction compensation stop parameter
2098	Word axis	Current phase lead compensation coefficient
2099	Word axis	N-pulse suppression level
2101	Word axis	Overshoot compensation effective level
2102	Word axis	Final clamp value for actual current limit
2103	Word axis	Amount of track back upon detection of unexpected disturbance torque
2104	Word axis	Threshold for detecting abnormal load during cutting
2105	Word axis	Torque constant
2107	Word axis	Velocity loop gain override
2109	Word axis	Fine acceleration/deceleration time constant (BELLTC)
2110	Word axis	Magnetic saturation compensation (base/coefficient)
2111	Word axis	Deceleration torque limit (base/coefficient)
2112	Word axis	AMR conversion coefficient 1
2113	Word axis	Notch filter center frequency (Hz)
2114	Word axis	Stage 2 acceleration amount override for two-stage backlash acceleration
2116	Word axis	Abnormal load detection, dynamic friction compensation value
2118	Word axis	Excessive error level between semi-closed and closed loops for dual position feedback.
2119	Word axis	Stop level with variable proportional gain
2121	Word axis	Conversion coefficient for number of feedback pulses
2122	Word axis	Conversion coefficient for detected resistance
2126	Word axis	Tandem control, time constant for switching position feedback
2127	Word axis	Non-interacting control coefficient
2128	Word axis	Weak magnetic flux compensation (coefficient)
2129	Word axis	Weak magnetic flux compensation (base/limit)

No.	Data type	Contents							
2130	Word axis	Two thrust ripple compensations per magnetic pole pair							
2131	Word axis	Four thrust ripple compensations per magnetic pole pair							
2132	Word axis	Six thrust ripple compensations per magnetic pole pair							
2133	Word axis	Deceleration phase delay compensation coefficient (PHDLY1)							
2134	Word axis	Deceleration phase delay compensation coefficient (PHDLY2)							
2137	Word axis	Stage 1 acceleration amount override for two-stage backlash acceleration							
2138	Word axis	Linear motor AMR conversion coefficient 2							
2139	Word axis	Linear motor AMR offset							
2142	Word axis	Threshold for detecting abnormal load during rapid traverse							
2143	Word axis	Fine acceleration/deceleration time constant 2 (ms)							
2144	Word axis	Position feed forward coefficient for cutting							
2145	Word axis	Velocity feed forward coefficient for cutting							
2146	Word axis	Two-stage backlash acceleration end timer							
2148	Word axis	Deceleration decision level (HRV control)							
2154	Word axis	Static friction compensation function. Decision level for movement restart after stop.							
2156	Word axis	Torque command filter (at cutting)							
2162	Word axis	Second overload protection coefficient (POVC21)							
2163	Word axis	Second overload protection coefficient (POVC22)							
2164	Word axis	Second overload protection coefficient (POVCLMT2)							
2165	Word axis	Maximum amplifier current							
2167	Word axis	Stage 2 acceleration amount offset for two-stage backlash acceleration							
2177	Word axis	Damping filter limit bandwidth (Hz)							
2180	Word axis	Linear motor thrust ripple correction.							
2185	Word axis	Position pulse conversion coefficient							
2200	Bit axis		P2EX			ABGO	IQOB		OVSP
2201	Bit axis		CPEE		SPVC			RNVL	CROF
2202	Bit axis				DUAL	OVS1	PIAL	VGCG	FAGO
2203	Bit axis				FRC2		1/2PI		
2204	Bit axis	ERC0		PGW2					
2205	Bit axis						FLDY		
2206	Bit axis	HSSR							
2207	Bit axis					PD50			
2209	Bit axis					FADL			
2210	Bit axis						PKGA		
2211	Bit axis							PHCP	
2212	Bit axis	OVQK							

4.19 PARAMETERS OF DI/DO

	#7	#6	#5	#4	#3	#2	#1	#0
3001	MHI					RWM		

[Data type] Bit

RWM RWD signal indicating that rewinding is in progress
 0 : Output only when the tape reader is being rewound by the reset and rewind signal RRW
 1 : Output when the tape reader is being rewound or a program in memory is being rewound by the reset and rewind signal RRW

MHI Exchange of strobe and completion signals for the M, S, T, and B codes
 0 : Normal
 1 : High-speed

	#7	#6	#5	#4	#3	#2	#1	#0
3002				IOV				

[Data type] Bit

IOV For the feedrate override signal, second feedrate override signal, and rapid traverse override signal:
 0 : Negative logic is used.
 1 : Positive logic is used.

	#7	#6	#5	#4	#3	#2	#1	#0
3003	MVG	MVX	DEC	DAU	DIT	ITX		ITL
		MVX	DEC		DIT	ITX		ITL

[Data type] Bit

ITL Interlock signal
 0 : Enabled
 1 : Disabled

ITX Interlock signals for each axis
 0 : Enabled
 1 : Disabled

DIT Interlock for each axis direction
 0 : Enabled
 1 : Disabled

DAU If bit 3 (DIT) of parameter No. 3003 is set to 0, the interlock signal of each axial direction is:
 0 : Enabled only in manual operation and disabled in automatic operation.
 1 : Enabled in both manual operation and automatic operation.

DEC Deceleration signal (*DEC1 to *DEC8) for reference position return
 0 : Deceleration is applied when the signal is 0.
 1 : Deceleration is applied when the signal is 1.

MVX The axis-in-movement signal is set to 0 when:
 0 : Distribution for the axis is completed. (The signal is set to 0 in deceleration.)
 1 : Deceleration of the axis is terminated, and the current position is in the in-position.

If, however, a parameter specifies not to make in-position during deceleration, the signal turns to "0" at the end of deceleration.

MVG While drawing using the dynamic graphics function (with no machine movement), the axis-in-movement signal is:

0 : Output

1 : Not output

NOTE

In case of M series the signal is not output.

	#7	#6	#5	#4	#3	#2	#1	#0
3004			OTH				BCY	BSL

[Data type] Bit

BSL The block start interlock signal *BSL and cutting block start interlock signal *CSL are:

0 : Disabled.

1 : Enabled.

BCY When more than one operation is performed by one block command such as a canned cycle, the block start interlock signal *BSL is:

0 : Checked only at the beginning of the first cycle.

1 : Checked at the beginning of every cycle.

NOTE

This is enabled when the BSL parameter (bit 0 of parameter No.3004) is set to 1.

OTH The overtravel limit signal is:

0 : Checked

1 : Not checked

WARNING

For safety, usually set 0 to check the overtravel limit signal.

	#7	#6	#5	#4	#3	#2	#1	#0
3006						EPS	EPN	GDC

GDC As the deceleration signal for reference position return:

0 : X009/X007 is used.

1 : G196/G1196 is used. (X009/X007 is disabled.)

EPN Workpiece number search signals are assigned to:

0 : PN1, PN2, PN4, PN8, and PN16.

1 : EPN0 to EPN13.

EPS When a program is searched using the workpiece number search function, it is started by:

0 : Automatic operation start signal ST (when automatic operation (memory operation) is started).

1 : Workpiece number search start signal EPNS <G025.7>. (Search is not started by ST.)

3010	Time lag in strobe signals MF, SF, TF, and BF
------	---

[Data type] Word

[Unit of data] 1 ms

[Valid data range] 16 to 32767

The time required to send strobe signals MF, SF, TF, and BF after the M, S, T, and B codes are sent, respectively.

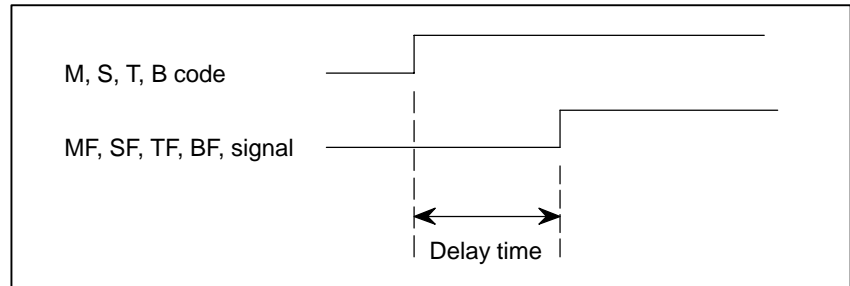

Fig.4.19 (a) Delay Time of the strobe signal

NOTE

The time is counted in units of 8 ms. If the set value is not a multiple of eight, it is raised to the next multiple of eight.

Example

When 30 is set, 32 ms is assumed.

When 32 is set, 32 ms is assumed.

When 100 is set, 104 ms is assumed.

3011	Acceptable width of M, S, T, and B function completion signal (FIN)
------	---

[Data type] Word

[Unit of data] 1 ms

[Valid data range] 16 to 32767

Set the minimum signal width of the valid M, S, T, and B function completion signal (FIN).

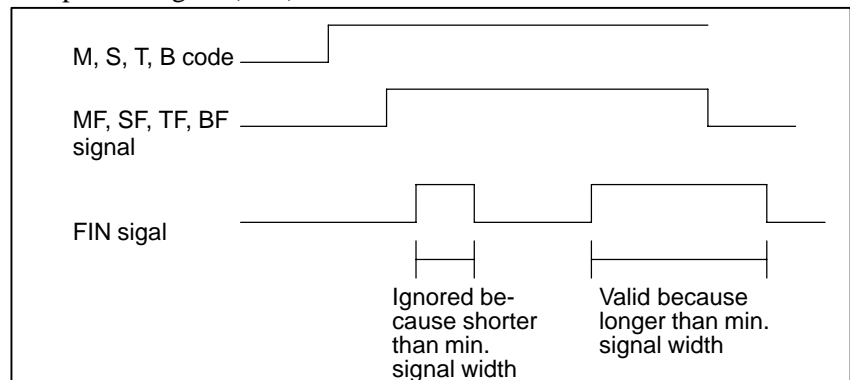

Fig.4.19 (b) Valid Width of the FIN (M,S, T, and B Function Completion) Signal

NOTE

The time is counted in units of 8 ms. If the set value is not a multiple of eight, it is raised to the next multiple of eight.

Example

When 30 is set, 32 ms is assumed.

3017

Output time of reset signal RST

[Data type] Byte

[Unit of data] 16 ms

[Valid data range] 0 to 255

To extend the output time of reset signal RST, the time to be added is specified in this parameter.

$\text{RST signal output time} = \text{time required for reset} + \text{parameter} \times 16 \text{ ms}$

3030

Allowable number of digits for the M code

3031

Allowable number of digits for the S code

3032

Allowable number of digits for the T code

3033

Allowable number of digits for the B code

[Data type] Byte

[Valid data range] 1 to 8

Set the allowable numbers of digits for the M, S, T, and B codes.

NOTE

Up to 5 digits can be specified in the S code

4.20 PARAMETERS OF MDI, DISPLAY, AND EDIT

	#7	#6	#5	#4	#3	#2	#1	#0
3100	COR			FPT	FKY	SKY	CEM	
	COR				FKY	SKY	CEM	

[Data type] Bit

CEM On screens such as the operation history screen and help screen, keys on the MDI panel are indicated:

0 : In English.

1 : With graphics qualifying for CE marking. (A character generator supporting graphics qualifying for CE marking is required.)

SKY MDI key board use:

0 : Standard keys.

1 : Small keys.

NOTE

Set this parameter when using the 9.5"/10.4" LCD (with ten soft keys). After this parameter has been set, the power must be turned off then back on for the setting to become effective.

FKY MDI keyboard

0 : Small type keys are used.

1 : Standard keys are used.

NOTE

Set this parameter when using the 7.2"/8.4" LCD (with seven soft keys). After this parameter has been set, the power must be turned off then back on for the setting to become effective.

FPT MDI keyboard for CAP-II

0 : Not used.

1 : Used

NOTE

When CAP-II function is equipped, this parameter is not required to be set to 1.

COR Display

0 : Monochrome display

1 : Color display

NOTE



When using the 8.4" LCD, set this bit to 1.

	#7	#6	#5	#4	#3	#2	#1	#0
3101	SBA			BGD			KBF	
				BGD			KBF	

[Data type] Bit

- KBF** When the screen or mode is changed, the contents of the key-in buffer are:
 0 : Cleared.
 1 : Not cleared.

NOTE

When KBF = 1, the contents of the key-in buffer can all be cleared at one time by pressing the  key followed by the  key.

- BGD** In background editing, a program currently selected in the foreground:
 0 : Cannot be selected. (BP/S alarm No.140 is issued disabling selection.)
 1 : Can be selected. (However, the program cannot be edited, only displayed.)
- SBA** When two systems are controlled, the current positions on the current position display screen are displayed:
 0 : In the order of tool post 1, followed by tool post 2.
 1 : In the order of tool post 2, followed by tool post 1.

	#7	#6	#5	#4	#3	#2	#1	#0
3102		SPN	HNG	ITA	CHI	FRN	GRM	JPN
	DTH	SPN	HNG	ITA	CHI	FRAN	GRM	JPN
3119							POR	
3190					HUN			

NOTE

When this parameter has been set, the power must be turned off before operation is continued.

[Data type] Bit

Select the language to be used for the display.

HUN	DTH	POR	SPN	HNG	ITA	CHI	FRN	GRM	JPN	Language
0	0	0	0	0	0	0	0	0	0	English
0	0	0	0	0	0	0	0	0	1	Japanese
0	0	0	0	0	0	0	0	1	0	German
0	0	0	0	0	0	0	1	0	0	French
0	0	0	0	0	0	1	0	0	0	Chinese
0	0	0	0	0	1	0	0	0	0	Italian
0	0	0	0	1	0	0	0	0	0	Korean
0	0	0	1	0	0	0	0	0	0	Spanish
0	0	1	0	0	0	0	0	0	0	Portuguese
0	1	0	0	0	0	0	0	0	0	Dutch
1	0	0	0	0	0	0	0	0	0	Hungarian

	#7	#6	#5	#4	#3	#2	#1	#0
3103	ABR					NMH	DIP	
						NMH		

[Data type] Bit

- DIP** When two-path control is applied, the current position display screen displays:
- 0 : The current positions of the two paths regardless of the tool post select signal.
 - 1 : The current position of a path selected by the tool post select signal.

NOTE

Set this parameter when using the display with seven soft keys.

- NMH** The system alarm history screen is:
- 0 : Not displayed.
 - 1 : Displayed.

- ABR** When two systems are controlled using a 7-pieces type soft key display unit and absolute position/relative position display requires two current position display screens (when five or more controlled axes are involved in total):
- 0 : The first screen displays tool post 1 data and the second screen displays tool post 2 data.
 - 1 : The first screen displays the data of the tool post selected with the tool post selection signal and the second screen displays the data of the other tool post.

NOTE

When ABR=1, bit7 (SBA) of parameter No.3101 is disabled.

	#7	#6	#5	#4	#3	#2	#1	#0
3104	DAC	DAL	DRC	DRL	PPD			MCN

[Data type] Bit**MCN** Machine position

0 : Not displayed according to the unit of input.

(Regardless of whether input is made in mm or inches, the machine position is displayed in mm for millimeter machines, or in inches for inch machines.)

1 : Displayed according to the unit of input.

(When input is made in mm, the machine position is displayed in mm, and when input is made in inches, the machine position is displayed in inches accordingly.)

PPD Relative position display when a coordinate system is set

0 : Not preset

1 : Preset

NOTE

When PPD is set to 1 and the absolute position display is preset by one of the following, the relative position display is also preset to the same value as the absolute position display:

- 1) The manual reference position return
- 2) Setting of a coordinate system by G92 (G50 for T series G code system A)

DRL Relative position

0 : The actual position displayed takes into account tool length offset (M series) or tool offset (T series).

1 : The programmed position displayed does not take into account tool length offset (M series) or tool offset (T series).

NOTE

When tool geometry compensation of the T system is to be performed by shifting the coordinate system (with bit 4 (LGT) of parameter No.5002 set to 0), the programmed position, ignoring tool offset, is displayed (with this parameter set to 1), but the programmed position, ignoring tool geometry compensation, cannot be displayed.

DRC Relative position

0 : The actual position displayed takes into account cutter compensation (M series) or tool nose radius compensation (T series).

1 : The programmed position displayed does not take into account cutter compensation (M series) or tool nose radius compensation (T series).

DAL Absolute position

0 : The actual position displayed takes into account tool length offset (M series) or tool offset (T series).

1 : The programmed position displayed does not take into account tool length offset (M series) or tool offset (T series).

NOTE

When tool geometry compensation of the T system is to be performed by shifting the coordinate system (with bit 4 (LGT) of parameter No.5002 set to 0), the programmed position, ignoring tool offset, is displayed (with this parameter set to 1), but the programmed position, ignoring tool geometry compensation, cannot be displayed.

DAC Absolute position

0 : The actual position displayed takes into account cutter compensation (M series) or tool nose radius compensation (T series).

1 : The programmed position displayed does not take into account cutter compensation (M series) or tool nose radius compensation (T series).

	#7	#6	#5	#4	#3	#2	#1	#0
3105						DPS	PCF	DPF
	SMF					DPS	PCF	DPF

[Data type] Bit

DPF Display of the actual speed on the current position display screen, program check screen and program screen (MD1 mode)

0 : Not displayed

1 : Displayed

PCF Addition of the movement of the PMC-controlled axes to the actual speed display

0 : Added

1 : Not added

NOTE

For each setting, movement along any axis other than those controlled by the CNC (see the description of parameter No. 1010) is not reflected in the actual speed display.

DPS Actual spindle speed and T code

0 : Not always displayed

1 : Always displayed

NOTE

For the M series, the threading and synchronous feed option is required to display the actual spindle speed.

SMF During simplified synchronous control, movement along a slave axis is:

0 : Included in the actual speed display

1 : Not included in the actual speed display

NOTE

This parameter is valid when simplified synchronous control is applied according to the setting of parameter No.8311 (master and slave axes can be arbitrarily selected).

	#7	#6	#5	#4	#3	#2	#1	#0
3106	OHS		SOV	OPH	SPD		GPL	
	OHS	DAK	SOV	OPH			GPL	

[Data type] Bit

DHD Simultaneous editing of the program screens of the two paths is:
 0 : Not performed.
 1 : Performed.

GPL On the program list screen, the list-by-group function is:
 0 : Disabled
 1 : Enabled

SPD Names for actual spindle speed values are displayed:
 0 : Regardless of the selected spindle position coder
 (in second position coder selection signal (PC2SLC))
 1 : Depending of the selected spindle position coder
 (in second position coder selection signal (PC2SLC))

SPD=0	SPD=1	
Spindles 1 and 2	Spindles 1	Spindles 2
S	S1	S2
SACT	SACT1	SACT2
ACT, S		

NOTE

When SPD is set to 1, during Two-path control, the actual spindle speed names for a spindle of path 2 are displayed in reverse video.

OPH The operation history screen is:
 0 : Not displayed.
 1 : Displayed.

SOV The spindle override value is:
 0 : Not displayed.
 1 : Displayed.

NOTE

This parameter is enabled only when bit 2 (DPS) of parameter No.3105 is set to 1.

DAK When absolute coordinates are displayed in the three-dimensional coordinate conversion mode:
 0 : Coordinates in the program coordinate system are displayed.
 1 : Coordinates in the workpiece coordinate system are displayed.

OHS Operation history sampling is:
 0 : Performed.
 1 : Not performed.

	#7	#6	#5	#4	#3	#2	#1	#0
3107	MDL			SOR		DNC		NAM

[Data type] Bit

- NAM** Program list
 0 : Only program numbers are displayed.
 1 : Program numbers and program names are displayed.
- DNC** Upon reset, the program display for DNC operation is:
 0 : Not cleared
 1 : Cleared
- SOR** Display of the program directory
 0 : Programs are listed in the order of registration.
 1 : Programs are listed in the order of program number.
- MDL** Display of the modal state on the program display screen
 0 : Not displayed
 1 : Displayed (only in the MDI mode)

	#7	#6	#5	#4	#3	#2	#1	#0
3108	JSP	SLM		WCI	PCT			

[Data type] Bit

- PCT** On the 7-pieces type soft key display program check screen and 12-pieces type soft key display position screen, T code displayed
 0 : is a T code specified in a program (T).
 1 : is a T code specified by the PMC (HD. T/NX. T)
- WCI** On the workpiece coordinate system screen, a counter input is:
 0 : Disabled.
 1 : Enabled.
- SLM** The spindle load meter is:
 0 : Not displayed.
 1 : Displayed.

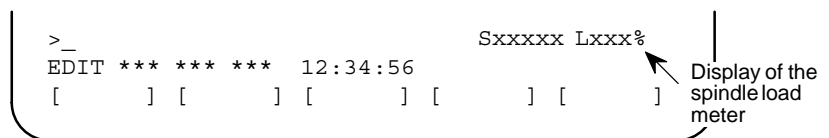

NOTE

- 1 This parameter is enabled only when the DPS parameter (bit 2 of parameter No.3105) is set to 1.
- 2 This is valid only for serial spindles.

- JSP** On the current position display screen and program check screen, jog feed is:
 0 : Not displayed.
 1 : Displayed.

NOTE

In manual operation mode, the jog feedrate is displayed. In automatic operation mode, the dry run feedrate is displayed. In each case, the feedrate to which a manual feedrate override has been applied is displayed.

JOG F	8000	PART COUNT	15
RUN TIME	1H17M	CYCLE TIME	1H15S
ACT.F	1000 MM/M		
MEM STRT MTN	***	12:34:59	
[]	[]	[]	[]

Jog feedrate

	#7	#6	#5	#4	#3	#2	#1	#0
3109			RHD			IKY	DWT	
		BGO	RHD			IKY	DWT	

[Data type] Bit

DWT Characters G and W in the display of tool wear/geometry compensation amount
 0 : The characters are displayed at the left of each number.
 1 : The characters are not displayed.

IKY On the tool offset screen and workpiece shift screen (T series), soft key **[INPUT]** is:
 0 : Displayed.
 1 : Not displayed.

RHD When a manual handle interrupt is generated, the relative position display is:
 0 : Not updated.
 1 : Updated.

NOTE

This parameter is enabled when the INH parameter (bit 2 of parameter No.7100) is 1.

BGO On the background drawing screen, when the  function key is pressed:
 0 : The machining-side screen is resumed.
 1 : A background drawing offset, workpiece coordinate system offset, and macro variable are displayed. (In this case, “BGGRP” appears in the bottom right section of the screen, enabling you to check the data for background drawing.)

	#7	#6	#5	#4	#3	#2	#1	#0
3110								OFA

[Data type] Bit

OFA The axis names on the offset screen and Y-axis offset screen are:
 0 : Always X, Z, and Y.
 1 : As specified by parameter No. 1020.

	#7	#6	#5	#4	#3	#2	#1	#0
3111	NPA	OPS	OPM			SVP	SPS	SVS

[Data type] Bit

- SVS** Servo tuning screen
0 : Not displayed
1 : Displayed
- SPS** Spindle tuning screen
0 : Not displayed
1 : Displayed
- SVP** Synchronization errors displayed on the spindle tuning screen
0 : Instantaneous values are displayed.
1 : Peak-hold values are displayed.
- OPM** Operating monitor
0 : Not displayed
1 : Displayed
- OPS** The speedometer on the operating monitor screen indicates:
0 : Spindle motor speed
1 : Spindle speed
- NPA** Action taken when an alarm is generated or when an operator message is entered
0 : The display shifts to the alarm or message screen.
1 : The display does not shift to the alarm or message screen.

	#7	#6	#5	#4	#3	#2	#1	#0
3112			OPH		EAH	OMH		SGD

NOTE

When this parameter is set, the power must be turned off before operation is continued.

[Data type] Bit

- SGD** Servo waveform
0 : Not displayed
1 : Displayed

NOTE

If SGD is set to 1, no graphic display other than servo waveform display is done.

- OMH** The external operator message history screen is:
0 : Not displayed.
1 : Displayed.
- EAH** Messages of the external alarm/macro alarm in alarm history:
0 : Not recorded
1 : Recorded
- OPH** The operation history log function is:
0 : Displayed.
1 : Enable.

	#7	#6	#5	#4	#3	#2	#1	#0
3113	MS1	MS0	DCL	TCH				MHC

[Data type] Bit

MHC External operator message history data:

0 : Cannot be cleared.

1 : Can be cleared.

(Such data can be cleared using the [**CLEAR**] soft key.)

TCH Cursor movement on the touch panel is:

0 : Disabled.

1 : Enabled.

DCL The compensation function for the touch panel on the display is:

0 : Disabled.

1 : Enabled.

MS0, MS1 A combination of the number of characters preserved as external operator message history data and the number of history data items is set according to the table below.

MS1	MS0	Number of history data characters	Number of history data items
0	0	255	8
0	1	200	10
1	0	100	18
1	1	50	32

NOTE

When the values of MS0 and MS1 are changed, all preserved external operator message history data is cleared.

	#7	#6	#5	#4	#3	#2	#1	#0
3114		ICS	IUS	IMS	ISY	IOF	IPR	IPO

[Data type] Bit

IPO When the  function key is pressed while the position display screen is being displayed:

0 : The screen is changed.

1 : The screen is not changed.

IPR When the  function key is pressed while the program screen is being displayed:





0 : The screen is changed.

1 : The screen is not changed.

IOF When the  function key is pressed while the offset/setting screen is being displayed:

0 : The screen is changed.

1 : The screen is not changed.

- ISY** When the  function key is pressed while the system screen is being displayed:
 0 : The screen is changed.
 1 : The screen is not changed.
- IMS** When the  function key is pressed while the message screen is being displayed:
 0 : The screen is changed.
 1 : The screen is not changed.
- IUS** When the  or  function key is pressed while the custom or graphic screen is being displayed:
 0 : The screen is changed.
 1 : The screen is not changed.
- ICS** When the  function key is pressed while the custom screen is being displayed:
 0 : The screen is changed.
 1 : The screen is not changed.

	#7	#6	#5	#4	#3	#2	#1	#0
3115					NDFx	SFMx	NDAx	NDPx
		D10x			NDFx		NDAx	NDPx

[Data type] Bit axis

- NDPx** Display of the current position for each axis
 0 : The current position is displayed.
 1 : The current position is not displayed.
- NDAx** Position display using absolute coordinates and relative coordinates is:
 0 : Performed.
 1 : Not performed. (Machine coordinates are displayed.)
- SFMx** In current position display, subscripts are:
 0 : Added to the absolute, relative, and machine coordinate axis names.
 1 : Assed only to the machine coordinate axis names.

NOTE
 This parameter is disabled when two systems are controlled.

- NDFx** To the actual speed display, axis movement data is:
 0 : Added.
 1 : Not added.

NOTE
 Even if the PCF parameter (bit 1 of parameter No.3105) is set to 0, so as to add PMC controlled axis movement data to the actual speed display, the movement data for a PMC controlled axis for which NDFx is set to 1 is not added to the actual speed display.

D10x The current positions (absolute position, relative position, machine position, remaining travel, and travel by manual handle interrupt), and workpiece zero-point offset are:

0 : Displayed as usual. (Not multiplied by ten.)

1 : Multiplied by ten, and displayed.

Example: The current position on the Y-axis is multiplied by ten and displayed.

X 1.2345 → X 1.2345

Y 1.2345 → Y 12.345

Z 1.2345 → Z 1.2345

	#7	#6	#5	#4	#3	#2	#1	#0
3116	MDC	T8D	COA	FOV		PWR		MDP

[Data type] Bit

MDP The memory card input/output screen is:

0 : Not displayed.

1 : Displayed.

PWR Alarm No.100 (parameter enable) :

0 : Clear by + key

1 : Clear by key

FOV In the field of specified feedrate F on the program check screen,

0 : The specified feedrate is displayed.

1 : (Specified feedrate) x (override) is displayed.

COA While an external alarm state is present or while an external message is being displayed, automatic screen erasure is:

0 : Performed.

1 : Not performed.

NOTE

The value of this parameter set for path 1 is valid. The values of path 2/3 or loader are invalid.

T8D T codes that are always displayed are displayed with:

0 : Four digits.

1 : Eight digits.

This parameter expands the T code display to eight digits for the continuous S or T display (bit 2 (DPS) of parameter No. 3105 is set to 1).

MDC Maintenance information by operating soft key :

0 : All clear disable.

1 : All clear enable.

	#7	#6	#5	#4	#3	#2	#1	#0
3117	P9D						SPP	
	P9D						SPP	SMS

NOTE

When this parameter is set, the power must be turned off before operation is continued.

[Data type] Bit

SMS On the program check screen, the soft key to enable or disable the graph of spindle speed and load is:

0 : Not displayed.

1 : Displayed.

SPP On the diagnostic screen, spindle position data (the number of pulses from the position coder, detected after the detection of the one-revolution signal) is:

0 : Not displayed.

1 : Displayed. (Diagnostic Nos. 445 to 447)

P9D The format of the screen displayed on the PC side by the NC screen display function is:

0 : 14-inch type.

1 : 9-inch type.

This parameter is valid when the NC is not equipped with a display unit.

	#7	#6	#5	#4	#3	#2	#1	#0
3118					AS4	AS3	AS2	AS1

[Data type] Bit

AS1 to AS4 When the actual spindle speeds (SACT) of the first spindle, second spindle, third spindle, and fourth spindle are displayed, each value is:

0 : The value calculated based on the feedback pulses from the position coder.

1 : The value calculated from the spindle motor speed (the same as the spindle speed displayed on the operating monitor screen).

NOTE

The fourth serial spindle can be used only with the 16i.

	#7	#6	#5	#4	#3	#2	#1	#0
3119	NVG			F2K	TPA	DDS	POR	
	NVG				TPA	DDS	POR	

NOTE

When this parameter is set, the power must be turned off before operation is continued.

[Data type] Bit**POR** Display in Portuguese is:

0 : Disabled.

1 : Enabled.

DDS The support of the touch panel on the display is:

0 : Enabled.

1 : Disabled.

TPA Touch panel connection is:

0 : Disabled.

1 : Enabled.

F2K As the LCD/MDI keyboard, Symbol CAPi T (CAP-II) combined with a unified standard keyboard is:

0 : Not used.

1 : Used.

NVG When a color display device is used, VGA mode is:

0 : Used.

1 : Not used.

3120

Time from the output of an alarm to the termination of sampling (waveform diagnosis function)

[Data type] Word**[Unit of data]** ms**[Valid data range]** 1 to 32760

When the waveform diagnosis function is used, this parameter sets the time from the output of a servo alarm until data collection. Storage operation is stopped because of the alarm. (This means that the termination of data collection can be delayed by a specified time.)

3122

Time interval used to record time data in operation history

[Data type] Word**[Unit of data]** min**[Valid data range]** 0 to 1439

Time data is recorded in operation history at set intervals. When 0 is specified in this parameter, 10 minutes is assumed as the default. However, note that time data is not recorded if there is no data to be recorded at the specified time.

3123

Time until screen clear function is applied

[Data type] Byte**[Unit of data]** min**[Valid data range]** 1 to 255

This parameter specifies the period that must elapse before the screen clear function is applied. If 0 is set, the screen is not cleared.

Moreover, this parameter is valid only when it is set on the path 1 side.

	#7	#6	#5	#4	#3	#2	#1	#0
3124	D08	D07	D06	D05	D04	D03	D02	D01
3125	D16	D15	D14	D13	D12	D11	D10	D09
3126	D24	D23	D22	D21	D20	D19	D18	D17
3127								D25

[Data type] Bit

Dxx (xx: 01 to 25) When modal G code is displayed on the program check screen and the program check-P screen when two-path control is applied, the xx group G code is:
 0 : Displayed.
 1 : Not displayed.

NOTE
 Set these parameters when using the display with seven soft keys.

3130	Axis display order for current position display screens

[Data type] Byte axis

[Valid data range] 0, 1 to the number of controlled axes

This parameter specifies the order in which axes are displayed on the current position display screens (absolute, relative, overall, and handle interrupt screens) during two-path control when the 7-pieces type soft key display is used.

NOTE
 This parameter is valid only for the common screens for two-path control. Axes are displayed in the order of their axis numbers on individual screens for each path and two-axis simultaneous display screens.

3131	Subscript of each axis name
------	-----------------------------

[Data type] Byte axis

This parameter specifies a subscript (one character) of each axis name with a code (two-path control).
 The one character subscript specified by this parameter is displayed after the axis name on the current position screen to discriminate the coordinates of axes belonging to one path from those of another path.

NOTE
 1 This parameter is dedicated to the two-path control.
 2 Specify this parameter for each path.
 3 For characters and codes, see the correspondence table in Appendix A.
 4 When code 0 is specified, 1 or 2 is displayed.

[Example] When the configuration of axes is X, Z, C and Y in path 1 and X, Z, and B in path 2

(1) Setting for path 1

Parameter 3131x	65 (A)	
Parameter 3131z	49 (1)	XA, Z1, CS, and Y1 are displayed as axis names.
Parameter 3131c	83 (S)	
Parameter 3131y	0 (1)	

(2) Setting for path 2

Parameter 3131x	66 (B)	XB, Z2, and B are displayed as axis names.
Parameter 3131z	0 (2)	
Parameter 3131b	32 (space)	

3132	Axis name (absolute coordinate) for current position display
3133	Axis name (relative coordinate) for current position display

[Data type] Byte axis

[Valid data range] 0 to 255

These parameters set the axis name for current position display.

When G code system B or C is used, the axis name set in parameter No.3132 is used for both absolute and relative coordinate axes.

The values set in these parameters are used only for display. For a command address, the axis name set in parameter No.1020 is used.

When 0 is specified in these parameters, the value set in parameter No.1020 is used.

3134	Axis display order on workpiece coordinate system screen and workpiece shift screen
------	---

[Data type] Byte axis

[Valid data range] 0, 1 to the number of controlled axes

This parameter specifies the order in which axes are displayed on the workpiece coordinate system screen and workpiece shift screen (for T series).

When the parameters of all axes are set to 0, all axes are displayed.

When the parameters of some axes are set, the axes for which a value of 0 is specified do not appear. The displayed axes are consecutive without spaces being left for non-displayed axes.

3140	Display color for path name
------	-----------------------------

[Data type] Byte

[Valid data range] -7 to 7

This parameter sets the display color for a path name. The values that can be set and their corresponding display colors are shown in the following table:

Setting	Display color
0	Standard display colors(*1)
1/-1	Red/red in reverse video
2/-2	Green/green in reverse video
3/-3	Yellow/yellow in reverse video
4/-4	Blue/blue in reverse video
5/-5	Purple/purple in reverse video
6/-6	Light blue/light blue in reverse video
7/-7	White/white in reverse video

*1 The standard display colors are as follows:

Status display for path 1:

Yellow

Status display for path 2:

Yellow in reverse video

Alarm, message, and program check screen:

Light blue

3141	Path name (1st character)
3142	Path name (2nd character)
3143	Path name (3rd character)
3144	Path name (4th character)
3145	Path name (5th character)
3146	Path name (6th character)
3147	Path name (7th character)

[Data type] Byte

Specify a path name with codes (two-path control).

Any character string consisting of alphanumeric characters, katakana characters, and special characters with a maximum length of seven characters can be displayed as a series name.

NOTE

- 1 This parameter is dedicated to the two-path control. Specify these parameters for each series.
- 2 For characters and codes, see the correspondence table in Appendix A.
- 3 When codes are 0, HEAD1 and HEAD2 for T series and PATH1 or PATH2 for M series are displayed.

[Example] When the names of path 1 and 2 are specified as TURRET1 and TURRET2, respectively.

- | | |
|--|--|
| <p>(1) Setting for path 1</p> <p>Parameter 3141 = 84 (T)</p> <p>Parameter 3142 = 85 (U)</p> <p>Parameter 3143 = 82 (R)</p> <p>Parameter 3144 = 82 (R)</p> <p>Parameter 3145 = 69 (E)</p> <p>Parameter 3146 = 84 (T)</p> <p>Parameter 3147 = 49 (1)</p> | <p>(2) Setting for path 2</p> <p>Parameter 3141 = 84 (T)</p> <p>Parameter 3142 = 85 (U)</p> <p>Parameter 3143 = 82 (R)</p> <p>Parameter 3144 = 82 (R)</p> <p>Parameter 3145 = 69 (E)</p> <p>Parameter 3146 = 84 (T)</p> <p>Parameter 3147 = 50 (2)</p> |
|--|--|

3151	Number of the axis for which the first load meter for the servo motor is used
3152	Number of the axis for which the second load meter for the servo motor is used
3153	Number of the axis for which the third load meter for the servo motor is used
3154	Number of the axis for which the fourth load meter for servo motor is used
3155	Number of the axis for which the fifth load meter for servo motor is used
3156	Number of the axis for which the sixth load meter for servo motor is used
3157	Number of the axis for which the seventh load meter for servo motor is used
3158	Number of the axis for which the eighth load meter for servo motor is used

[Data type] Byte

[Valid data range] 0, 1, . . . , the number of control axes

Set the numbers of the axes for which measurement values on the load meters for the eight servo motors are displayed. Set the parameters to 0 for those axes for which a load meter need not be displayed.

3163	Time required to smooth the spindle load meter readings
------	---

[Data type] Byte

[Unit of data] 32 ms

[Valid data range] 0 to 32

When the spindle load meter reading is displayed (see the description of the SLM parameter (bit 6 of parameter No.3108)), smoothing can be applied to the spindle load meter reading to prevent flickering. This parameter sets the time width for smoothing.

Setting	Time for smoothing (msec)
0	256
1	32
2	64
3	96
:	:
:	:
32	1024

Each smoothing operation is performed for a time width of between 32 ms and 1024 ms.

	#7	#6	#5	#4	#3	#2	#1	#0
3190					HUN			

NOTE

When this parameter has been set, the power must be turned off before operation is continued.

[Data type] Bit

HUN Hungarian display is:
 0 : Not performed.
 1 : Performed.

	#7	#6	#5	#4	#3	#2	#1	#0
3191			FSS		STS			FPS
					STS	WKI		

[Data type] Bit

FPS The unit function (feed per revolution) for actual cutting feedrate display displays numerals of:
 0 : Feedrate per minute.
 1 : Feedrate per spindle revolution.

WKI On the workpiece coordinate system setting screen, the soft key [INPUT] is:
 0 : Displayed.
 1 : Not displayed.

STS When data is input on the setting screen, a confirmation message is:
 0 : Not displayed.
 1 : Displayed.

FSS The feedrate display is switched:
 0 : In accordance with the operation state.
 1 : By a DI signal.

	#7	#6	#5	#4	#3	#2	#1	#0
3192				TB2	TBZ	TRA	T2P	TTP
3192				TB2	TBZ	TRA	T2P	

[Data type] Bit

TTP Under multipath control, on the parameter screen, diagnosis screen, and setting screen (parameter portion) of paths 1 and 2, numbers are:
 0 : Checked.
 1 : Not checked.

In the third path under three-path control by 2 CPUs, numbers are not checked on the screens indicated above.

T2P If two points are pressed on the touch panel, it is assumed that:
 0 : A mid point is pressed.
 1 : The first point is pressed.

NOTE

- 1 If two or more points are pressed during a sampling period, it is assumed that a mid point is pressed.
- 2 If a C executer application or the like has a touch panel drag (move in pressed state) function, set this parameter to 0.
- 3 In open CNC, the parameter is valid just for CNC screen display function.

TRA If a point on the touch panel is kept pressed for a time specified in parameter No. 3197 or longer,
 0 : P/S alarm 5303 is not raised.
 1 : P/S alarm 5303 is raised.

NOTE

- 1 If an C executer application or the like has a touch panel repeat (continue pressing) function, set this parameter to 0.
- 2 In open CNC, the parameter is valid just for the CNC screen display function.

TBZ If a point on the touch panel is pressed,
 0 : The buzzer does not sound.
 1 : The buzzer sounds.

NOTE

This improvement is valid if the hardware is equipped with a separate buzzer.

TB2 If a buzzer is provided and if bit 3 (TBZ) of parameter No. 3192 is set to 1,
 0 : Pressing any point on the touch panel causes the buzzer to sound. If any point is kept pressed, the buzzer continues sounding.
 1 : The buzzer sounds when the pressing on the touch panel is recognized as a key.

3197	Detection time of continuous pressing on touch panel
------	--

[Data type] Byte

[Unit of data] s

[Valid data range] 0 to 255

This parameter is valid if bit 2 (TRA) of parameter No. 3192 is set to 1. Set a period of continuous pressing on the touch panel which causes P/S5305 alarm to be raised. If 0 is set, a period of 20 s is assumed.

	#7	#6	#5	#4	#3	#2	#1	#0
3201	MIP	NPE	N99		PUO	REP	RAL	RDL

[Data type] Bit

RDL When a program is registered by input/output device external control
 0 : The new program is registered following the programs already registered.
 1 : All registered programs are deleted, then the new program is registered.
 Note that programs which are protected from being edited are not deleted.

- RAL** When programs are registered through the reader/puncher interface
 0 : All programs are registered.
 1 : Only one program is registered.
- REP** Action in response to an attempt to register a program whose number is the same as that of an existing program
 0 : An alarm is generated.
 1 : The existing program is deleted, then the new program is registered.
 Note that if the existing program is protected from being edited, it is not deleted, and an alarm is generated.
- PUO** When address O of a program number is output in ISO code:
 0 : “:” is output.
 1 : “O” is output.
- N99** With an M99 block, when bit 6 (NPE) of parameter No.3201 = 0, program registration is assumed to be:
 0 : Completed
 1 : Not completed
- NPE** With an M02, M30, or M99 block, program registration is assumed to be:
 0 : Completed
 1 : Not completed
- MIP** Program registration by external start signal (MINP) :
 0 : Not performed.
 1 : Performed.

	#7	#6	#5	#4	#3	#2	#1	#0
3202		PSR	CPD	NE9	OSR	CND	OLV	NE8

[Data type] Bit

- NE8** Editing of subprograms with program numbers 8000 to 8999
 0 : Not inhibited
 1 : Inhibited
- The following edit operations are disabled:
- (1) Program deletion (Even when deletion of all programs is specified, programs with program numbers 8000 to 8999 are not deleted.)
 - (2) Program output (Even when outputting all programs is specified, programs with program numbers 8000 to 8999 are not output.)
 - (3) Program number search
 - (4) Program editing of registered programs
 - (5) Program registration
 - (6) Program collation
 - (7) Displaying programs
- OLV** When a program other than the selected program is deleted or output:
 0 : The display of the selected program is not held.
 1 : The display of the selected program is held.
- CND** By using the [**CONDENSE**] soft key on the program directory screen, the program condensing operation is:
 0 : Not performed. (The [**CONDENSE**] soft key is not displayed.)
 1 : Performed.

OSR In programming number search, when pressing soft key [**O-SEARCH**] without inputting program number by key :
 0 : Search the following program number
 1 : Operation is invalid

NE9 Editing of subprograms with program numbers 9000 to 9999
 0 : Not inhibited
 1 : Inhibited

The following program editing during operation is invalid.

- (1) Program deletion (Even when deletion of all programs is specified, programs with program numbers 9000 to 9999 are not deleted.)
- (2) Program punching (Even when punching of all programs is specified, programs with program numbers 9000 to 9999 are not punched.)
- (3) Program number search
- (4) Program editing after registration
- (5) Program registration
- (6) Program collation
- (7) Displaying programs

CPD When an NC program is deleted, a confirmation message and confirmation soft key are:
 0 : Not output.
 1 : Output.

PSR Search for the program number of a protected program
 0 : Disabled
 1 : Enabled

NOTE

If this parameter is set, a protected program is also displayed.

	#7	#6	#5	#4	#3	#2	#1	#0
3203	MCL	MER	MZE	PIO				
	MCL	MER	MZE					

[Data type] Bit

PIO When two-path control is controlled, program input/output is:
 0 : Controlled separately for each tool post.
 1 : Controlled on a two-path control basis for path 1 and path 2.

MZE After MDI operation is started, program editing during operation is:
 0 : Enabled
 1 : Disabled

MER When the last block of a program has been executed at single block operation in the MDI mode, the executed block is:
 0 : Not deleted
 1 : Deleted

NOTE

When MER is set to 0, the program is deleted if the end-of-record mark (%) is read and executed. (The mark % is automatically inserted at the end of a program.)

MCL Whether a program prepared in the MDI mode is cleared by reset
 0 : Not deleted
 1 : deleted

	#7	#6	#5	#4	#3	#2	#1	#0
3204		MKP	SPR	P9E	P8E	EXK		PAR

[Data type] Bit

PAR When a small keyboard is used, characters “[” and “]” are:
 0 : Used as “[” and “]”.
 1 : Used as “(” and “)”.

EXK The input character extension function is:
 0 : Not used. ([C-EXT] soft key is displayed.)
 1 : Used.

NOTE

The [C-EXT] soft key is used to select an operation on the program screen. This soft key enables the entry of “(”, “)”, and “@” using soft keys. This soft key is useful when using the small MDI keyboard, which does not have the “(”, “)”, and “@” keys.

P8E Editing of subprograms 80000000 to 89999999 is:
 0 : Not inhibited
 1 : Inhibited

The following editing types become impossible.

- (1) Program deletion (Programs numbered in the 80000000 range will not be deleted even if all-program deletion is specified.)
- (2) Program output (Programs numbered in the 80000000 range will not be output even if all-program output specified.)
- (3) Program search by number
- (4) Program editing after registration
- (5) Program registration
- (6) Program collation
- (7) Program display

P9E Editing of subprograms 90000000 to 99999999 are:
 0 : Not inhibited
 1 : Inhibited

The following editing types become impossible.

- (1) Program deletion (Programs numbered in the 90000000 range will not be deleted even if all-program deletion is specified.)
- (2) Program output (Programs numbered in the 90000000 range will not be output even if all-program output specified.)

- (3) Program search by number
- (4) Program editing after registration
- (5) Program registration
- (6) Program collation
- (7) Program display

SPR Program numbers in the 9000 range for specific programs are:
 0 : Not added with 90000000
 1 : Added with 90000000

[Example]

The program numbers for G codes used to call custom macros are as follows:

SPR = 0: 00009010 to 00009019

SPR = 1: 90009010 to 90009019

Subprogram numbers 9500 to 9510 used by the pattern data input function are as follows:

SPR = 0: 00009500 to 00009510

SPR = 1: 90009500 to 90009510

MKP When M02, M30, or EOR(%) is executed during MDI operation, the created MDI program is:
 0 : Erased automatically.
 1 : Not erased automatically.

NOTE

If the MER parameter (bit 6 of parameter No.3203) is 1, executing the last block provides a choice of whether to automatically erase a created program.

	#7	#6	#5	#4	#3	#2	#1	#0
3205	MCK			OSC	PNS	CMO	CHG	COL

[Data type] Bit

- COL** When a program is displayed or output, any colons (:) in the comments of the program are:
 0 : Converted to letter O
 1 : Displayed or output as is
- CHG** When the change function of the extended edit function is used:
 0 : Once the user has decided whether to make a change, the cursor is moved to the target position.
 1 : The cursor is moved to the change source, after which the user can choose whether to make a change.
- CMO** In extended tape editing, the copy or move operation:
 0 : Is performed in the usual way.
 1 : Can also copy or move data from a program to a key-in buffer in units of words.
- PNS** On the program screen, a search by a cursor key is:
 0 : Performed.
 1 : Not performed.

OSC On the offset screen, offset value erasure by a soft key is:
 0 : Enabled.
 1 : Disabled.

MCK The system tape memory check function is:
 0 : Not used.
 1 : Used. (This setting is inhibited.)

	#7	#6	#5	#4	#3	#2	#1	#0
3206				PHS			MIF	PCP

[Data type] Bit

PCP Program copy operation between two paths is:
 0 : Disabled.
 1 : Enabled.

MIF Editing of the maintenance information screen is:
 0 : Not prohibited.
 1 : Prohibited.

PHS The selection of an operation history signal and parameters (No. 12801 to No. 128900) are:
 0 : Not linked.
 1 : Linked.

	#7	#6	#5	#4	#3	#2	#1	#0
3207								OM4

NOTE

When this parameter has been set, the power must be turned off before operation is continued.

[Data type] Bit

OM4 A message displayed on the external operator message screen can have:
 0 : Up to 256 characters, and just a single message can be displayed.
 1 : Up to 64 characters, and up to four messages can be displayed.

	#7	#6	#5	#4	#3	#2	#1	#0
3208							COK	SKY

[Data type] Bit

SKY The function key [SYSTEM] on the MDI panel is:
 0 : Enabled.
 1 : Disabled.

COK The automatic screen erase function is:
 0 : Enabled.
 1 : Disabled.

NOTE

- 1 The setting specified for path 1 is followed. The setting for path 2/3 or loader is ignored.
- 2 If this parameter is set to 1, screen erasure by the CAN + FUNCTION key is enabled, irrespective of the setting of parameter No. 3123.

	#7	#6	#5	#4	#3	#2	#1	#0
3209								MPD

[Data type] Bit

MPD When a subprogram is executed, the main program number is:

0 : Not displayed.

1 : Displayed.

3210	Password
------	----------

[Data type] 2–word axis

This parameter sets a password for protecting program Nos. 9000 to 9999. When a value other than zero is set in this parameter and this value differs from the keyword set in parameter No.3211, bit 4 (NE9) of parameter No.3202 for protecting program Nos. 9000 to 9999 is automatically set to 1. This disables the editing of program Nos. 9000 to 9999. Until the value set as the password is set as a keyword, NE9 cannot be set to 0 and the password cannot be modified.

NOTE

- 1 The state where password \neq 0 and password \neq keyword is referred to as the locked state. When an attempt is made to modify the password by MDI input operation in this state, the warning message "WRITE PROTECTED" is displayed to indicate that the password cannot be modified. When an attempt is made to modify the password with G10 (programmable parameter input), P/S alarm No.231 is issued.
- 2 When the value of the password is not 0, the parameter screen does not display the password. Care must be taken in setting a password.

3211	Keyword
------	---------

[Data type] 2–word axis

When the value set as the password (set in parameter No.3210) is set in this parameter, the locked state is released and the user can now modify the password and the value set in bit 4 (NE9) of parameter No.3202.

NOTE

The value set in this parameter is not displayed. When the power is turned off, this parameter is set to 0.

3216	Increment in sequence numbers inserted automatically
------	--

Setting entry is acceptable.

[Data type] Word

[Valid data range] 0 to 9999

Set the increment for sequence numbers for automatic sequence number insertion (when SEQ, #5 of parameter 0000, is set to 1.)

3218	Program number to be registered in synchronous input/output operation (4-digit program number)
------	--

[Data type] Word

[Valid data range] 1 to 9999

When a program entered through the input/output unit is executed and registered in memory at the same time in synchronous input/output operation, this parameter sets a program number for that program.

NOTE

- 1 If a value that falls outside the valid data range is specified, the number of the input program is used as is as the registered program number.
- 2 When the 8-digit program number function is used, use parameter No.3219 instead of parameter No.3218.

3219	Program number to be registered in synchronous input/output operation (8-digit program number)
------	--

[Data type] 2-word

[Valid data range] 0 to 99999999

When a program entered through the input/output unit is executed and registered in memory at the same time in synchronous input/output operation, this parameter sets a program number for that program.

NOTE

- 1 If a value that falls outside the valid data range is specified, the number of the input program is used as is as the registered program number.
- 2 When the 8-digit program number function is not used, use parameter No.3218 instead of parameter No.3219.

3220	Password
------	----------

[Data type] 2-word

[Valid data range] 0 to 99999999

This parameter sets a password.

When a value other than zero is set for this parameter, it is regarded as being a password. Once a password has been set, the display of the setting (password) field is cleared. In addition, program display, input/output, and editing operations are locked.

The parameter can be set when the parameter is unlocked, that is, when the parameter is 0, or when the value of this parameter is the same as the keyword (parameter No.3221).

CAUTION

This parameter is used to encrypt keys and programs.

3221	Keyword
------	---------

[Data type] 2-word

[Valid data range] 0 to 99999999

When the same value as the password is set in this parameter, the lock is released (unlock state). The value set in this parameter is not displayed.

CAUTION

This parameter is used to encrypt keys and programs.

3222	Program protection range (minimum value)
------	--

3223	Program protection range (maximum value)
------	--

[Data type] 2-word

[Valid data range] 0 to 9999

Those programs whose program numbers are within the range set in these parameters can be locked. These parameters set the minimum and maximum values of the program numbers to be locked.

Example: When the minimum value = 7000 and the maximum value = 8499, programs O7000 to O8499 are locked.

When the minimum value = 0 and the maximum value = 0, programs O9000 to O9999 are locked.

3225	Cipher of safe parameter for dual check safety function
------	---

[Data type] 2-word

[Valid data range] 0 to 99999999

Set a cipher (password) for protecting a parameter related to dual check safety (safety parameter) from change. If a cipher for a safety parameter is set, the safety parameter is locked. Meanwhile, the setting (cipher) is displayed as blank characters, and the safety parameter cannot be input. An attempt to input a safety parameter while locked results in

consequences as indicated in the table below, depending on the input method, and the value cannot be input.

The value of cipher for safety parameter can be set while the safety parameter is not locked, that is, while the value of cipher for safety parameter is 0 or is the same as the lock for safety parameter (No. 3226). The following safety parameters can be protected by the cipher for safety parameter.

No.1023, No.1829, No.1838, No.1902 #3, No.1902 #6, No.1942, No.1943, No.1944, No.1945, No.1946, No.1947, No.1948, No.3225, No.4372

Input method	Result
MDI input	Warning "WRITE-PROTECTED"
G10 (programmable parameter input)	P/S231 The G10 L50 format is incorrect.
Input by reader/punch interface	No alarm is raised, but the parameter is not input.
Input by window	Completion code7 (write protect)

3226

Lock of safety parameter for dual check safety function

[Data type] 2-word

[Valid data range] 0 to 99999999

If the same value as the cipher for safety parameter is specified in this parameter, the lock is unlocked, and the safety parameter can be changed. The setting is not displayed. When the power is turned off, the setting is cleared, and the parameter is locked again.

CAUTION

Once a safety parameter is locked, the lock must be unlocked or a memory all clear operation must be carried out to change the safety parameter. In addition, the cipher for safety parameter cannot be used. Take great care when setting the cipher for safety parameter.

3241	Character blinking in the AI contour control mode (first character)
3242	Character blinking in the AI contour control mode (second character)
3243	Character blinking in the AI contour control mode (third character)
3244	Character blinking in the AI contour control mode (fourth character)
3245	Character blinking in the AI contour control mode (fifth character)
3246	Character blinking in the AI contour control mode (sixth character)
3247	Character blinking in the AI contour control mode (seventh character)

[Data type] Byte

[Valid data range] -128 to 127

Set the character codes of characters blinking in the AI contour control mode.

NOTE

If zeros are specified as the character codes, “ AICC” will blink.

3251	Character blinking in the AI nano contour control mode (first character)
3252	Character blinking in the AI nano contour control mode (second character)
3253	Character blinking in the AI nano contour control mode (third character)
3254	Character blinking in the AI nano contour control mode (fourth character)
3255	Character blinking in the AI nano contour control mode (fifth character)
3256	Character blinking in the AI nano contour control mode (sixth character)
3257	Character blinking in the AI nano contour control mode (seventh character)

[Data type] Byte

[Valid data range] –128 to 127

Set the character codes of characters blinking in the AI nano contour control mode.

NOTE

If zeros are specified as the character codes, “AI NANO” will blink.

	#7	#6	#5	#4	#3	#2	#1	#0
3260								LCH

NOTE

When this parameter has been set, the power must be turned off before operation is continued.

[Data type] Bit

LCH At power-up, the function to connect two LCD units selects:

0 : MDI of the LCD unit specified in parameter No. 3270.

1 : MDI of the LCD unit that was last selected, before power-down.

Supplemental remark : The number of the LCD unit that was last selected before power-down is automatically stored in parameter No. 3271.

3270	Number of the LCD unit of which MDI is selected at power-up
------	---

NOTE

When this parameter has been set, the power must be turned off before operation is continued.

[Data type] Byte

[Valid data range] 0, 1

If the function to connect two LCD units is used, set the LCD unit of which MDI is selected at power-up. This parameter is valid if bit 0 (LCH) of parameter No. 3260 is set to 0.

[Sample settings]

- If just a single LCD is connected, set 0.
- If two LCD units are connected and if MDI of the second unit is selected, set 1.

NOTE

If the setting is greater than the number of actually connected units, MDI of the last LCD unit is selected.

3271	Number of the LCD unit of which MDI is being selected
------	---

[Data type] Byte

[Valid data range] 0, 1

The number of the LCD unit of which MDI is enabled is automatically set.

[Sample display]

- If just a single LCD unit is connected, 0 is displayed.
- If two LCD units are selected and if MDI of the second unit is selected, 1 is displayed.

NOTE

The setting cannot be changed from MDI or the like.

	#7	#6	#5	#4	#3	#2	#1	#0
3290	KEY	MCM		IWZ	WZO	MCV	GOF	WOF

[Data type] Bit

- WOF** Setting the tool offset value by MDI key input is:
 0 : Not disabled
 1 : Disabled (With parameter No.3294 and No.3295, set the offset number range in which updating the setting is to be disabled.)
- GOF** Setting the tool offset value by MDI key input is:
 0 : Not disabled
 1 : Disabled (With parameter No.3294 and No.3295, set the offset number range in which updating the setting is to be disabled.)
- MCV** Macro variable setting by MDI key input is:
 0 : Not disabled
 1 : Disabled
- WZO** Setting a workpiece zero point offset value by MDI key input is:
 0 : Not disabled
 1 : Disabled
- IWZ** Setting a workpiece zero point offset value or workpiece shift value (T-series) by MDI key input in the automatic operation activation or halt state is:
 0 : Not disabled
 1 : Disabled
- MCM** The setting of custom macros by MDI key operation is:
 0 : Enabled regardless of the mode.
 1 : Enabled only in the MDI mode.
- KEY** For memory protection keys:
 0 : The KEY1, KEY2, KEY3, and KEY4 signals are used.
 1 : Only the KEY1 signal is used.

NOTE

The functions of the signals depend on whether KEY=0 or KEY=1.

When KEY = 0:

- KEY1: Enables a tool offset value and a workpiece zero point offset value to be input.
- KEY2: Enables setting data and macro variables to be input.
- KEY3: Enables program registration and editing.
- KEY4: Enables PMC data (counter and data table) to be input.

When KEY = 1:

- KEY1: Enables program registration and editing, and enables PMC parameter input.
- KEY2 to KEY4: Not used

	#7	#6	#5	#4	#3	#2	#1	#0
3291								WPT

[Data type] Bit

WPT The input of the tool wear compensation amount is:
 0 : Enabled according to memory protection key signal KEY1.
 1 : Always enabled.

	#7	#6	#5	#4	#3	#2	#1	#0
3292	PK5							

[Data type] Bit

PK5 The KEYPRM signal (memory protection signal, parameter write setting) is:
 0 : Disabled.
 1 : Enabled.

3294	Start number of tool offset values whose input by MDI is disabled
3295	Number of tool offset values (from the start number) whose input by MDI is disabled

[Data type] Word

When the modification of tool offset values by MDI key input is to be disabled using bit 0 (WOF) of parameter No.3290 and bit 1 (GOF) of parameter No.3290, parameter Nos. 3294 and 3295 are used to set the range where such modification is disabled. In parameter No.3294, set the offset number of the start of tool offset values whose modification is disabled. In parameter No.3295, set the number of such values.

When 0 or a negative value is set in parameter No.3294 or parameter No.3295, no modification of the tool offset values is allowed.

When the value set with parameter No.3294 is greater than the maximum tool offset count, no modification is allowed.

[Example]

The following setting disables the modification of both the tool geometry compensation values and tool wear compensation values corresponding to offset numbers 51 to 60:

Bit 1 (GOF) of parameter No.3290=1 (Disables tool offset value modification.)

Bit 0 (WOF) of parameter No.3290=1 (Disables tool wear compensation value modification.)

Parameter No.3294 = 51

Parameter No.3295 = 60

If bit 0 (WOF) of parameter No.3290 is set to 0, the modification of the tool offset values alone is disabled. The tool wear compensation values may be modified.

	#7	#6	#5	#4	#3	#2	#1	#0
3301	HDC				HCG	HCA		HCC

[Data type] Bit

HCC In the VGA-compatible mode display,

0 : A 256-color bit map data of the screen hard copy is created.

1 : A 16-color bit map data of the screen hard copy is created.

HCA An alarm message related to hard copy is:

0 : Not displayed.

1 : Displayed.

HCG In a monochrome bit map,

0 : Black and white are not inverted. (same as the screen image)

1 : Black and white are inverted.

HDC A screen hard copy is:

0 : Not provided.

1 : Provided.

4.21 PARAMETERS OF PROGRAMS

3401	#7	#6	#5	#4	#3	#2	#1	#0
	GSC	GSB					FCD	DPI
			ABS	MAB				DPI

[Data type] Bit

DPI When a decimal point is omitted in an address that can include a decimal point

0 : The least input increment is assumed.

1 : The unit of mm, inches, or second is assumed. (Pocket calculator type decimal point input)

FCD When an F command and a G command (G98, G99) for feed per minute or feed per rotation are specified in the same block, and the G command (G98, G99) is specified after the F command, the F command is:

0 : Assumed to be specified in the mode (G98 or G99) when the F command is specified

1 : Assumed to be specified in the mode of the G command (G98 or G99) of the same block

NOTE

1 When FCD = 1:

If the block containing a G command (G98, G99) does not include an F command, the last F command specified is assumed to be specified in the G command mode of the block.

Example

N1 G99 ;

N2 Faaaa G98 ; - Faaaa is assumed to be specified in the G98 mode.

N3 Fbbbb ; - Fbbbb is assumed to be specified in the G98 mode.

N4 G99 ; - Fbbbb is assumed to be specified in the G99 mode.

2 In G code system B or C, G98 and G99 function are specified in G94 and G95.

MAB Switching between the absolute and incremental commands in MDI operation

0 : Performed by G90 or G91

1 : Depending on the setting of ABS, #5 of parameter No.3401

ABS Program command in MDI operation

0 : Assumed as an incremental command

1 : Assumed as an absolute command

NOTE

ABS is valid when MAB, #4 of parameter No.3401, is set to 1.

GSB, GSC The G code system is set.

GSC	GSB	G code
0	0	G code system A
0	1	G code system B
1	0	G code system C

	#7	#6	#5	#4	#3	#2	#1	#0
3402	G23	CLR			G91			G01
	G23	CLR			G91	G19	G18	G01

[Data type] Bit

G01 Mode entered when the power is turned on or when the control is cleared
 0 : G00 mode (positioning)
 1 : G01 mode (linear interpolation)

G18 and G19 Plane selected when power is turned on or when the control is cleared

G19	G18	G17, G18 or G19 mode
0	0	G17 mode (plane XY)
0	1	G18 mode (plane ZX)
1	0	G19 mode (plane YZ)

G91 When the power is turned on or when the control is cleared
 0 : G90 mode (absolute command)
 1 : G91 mode (incremental command)

CLR Reset button on the MDI panel, external reset signal, reset and rewind signal, and emergency stop signal
 0 : Cause reset state.
 1 : Cause clear state.

For the reset and clear states, refer to Appendix in the Operator's Manual.

G23 When the power is turned on
 0 : G22 mode (stored stroke check on)
 1 : G23 mode (stored stroke check off)

	#7	#6	#5	#4	#3	#2	#1	#0
3403		AD2	CIR					

[Data type] Bit

CIR When neither the distance (I, J, K) from a start point to the center nor an arc radius (R) is specified in circular interpolation (G02, G03):
 0 : The tool moves to an end point by linear interpolation.
 1 : P/S alarm No.022 is issued.

AD2 Specification of the same address two or more times in a block is:
 0 : Enabled (Next specification is enabled.)
 1 : Disabled (P/S alarm No.5074)

NOTE

- When 1 is set, specifying two or more G codes of the same group in a block will also result in an alarm being issued.
- Up to three M codes can be specified in a single block, when bit 7 (M3B) of parameter No.3404 is set to 1.

	#7	#6	#5	#4	#3	#2	#1	#0
3404	M3B	EOR	M02	M30		SBP	POL	
	M3B	EOR	M02	M30		SBP	POL	NOP

[Data type] Bit

- NOP** When a program is executed, a block consisting of an O number, EOB, or N number is:
 0 : Not ignored, but regarded as being one block.
 1 : Ignored.
- POL** For a command address allowing a decimal point, omission of the decimal point is:
 0 : Enabled
 1 : Disabled (P/S alarm No.5073)
- SBP** Address P of the block including M198 in the subprogram call function
 0 : Indicating a file number
 1 : Indicating a program number
- M30** When M30 is specified in a memory operation:
 0 : M30 is sent to the machine, and the head of the program is automatically searched for. So, when the ready signal FIN is returned and a reset or reset and rewind operation is not performed, the program is executed, starting from the beginning.
 1 : M30 is sent to the machine, but the head of the program is not searched for. (The head of the program is searched for by the reset and rewind signal.)
- M02** When M02 is specified in memory operation
 0 : M02 is sent to the machine, and the head of the program is automatically searched for. So, when the end signal FIN is returned and a reset or reset and rewind operation is not performed, the program is executed, starting from the beginning.
 1 : M02 is sent to the machine, but the head of the program is not searched for. (The head of the program is searched for by the reset and rewind signal.)
- EOR** When the end-of-record mark (%) is read during program execution:
 0 : P/S alarm No.5010 occurs. (Automatic operation is stopped, and the system enters the alarm state.)
 1 : No alarm occurs. (Automatic operation is stopped, and the system is reset.)
- M3B** The number of M codes that can be specified in one block
 0 : One
 1 : Up to three

	#7	#6	#5	#4	#3	#2	#1	#0
3405	QAB	QLG	DDP	CCR	G36	PPS	DWL	AUX
							DWL	AUX

[Data type] Bit

- AUX** The least increment of the command of the second miscellaneous function specified with a decimal point
0 : Assumed to be 0.001
1 : Depending on the input increment. (For input in mm, 0.001 is assumed, or for input in inches, 0.0001 is assumed.)
- DWL** The dwell time (G04) is:
0 : Always dwell per second.
1 : Dwell per second in the feed per minute mode, or dwell per rotation in the feed per rotation mode.
- PPS** The passing-point signal output function is:
0 : Not used
1 : Used
- G36** For a G code used with the automatic tool compensation function:
0 : G36/G37 is used.
1 : G37.1/G37.2 is used.

NOTE

If it is necessary to perform circular threading (counterclockwise), set this parameter to 1.

- CCR** Addresses used for chamfering and corner rounding
0 : Address used for chamfering and corner rounding is "I" or "K", not "C". In direct drawing dimension programming, addresses "C", "R", and "A" (with comma) are used in stead of "C", "R", and "A".
1 : Addresses used for chamfering, corner rounding, and direct drawing dimension programming are "C", "R", and "A" without comma. Thus, addresses A and C cannot be used as the names of axes.
- DDP** Angle commands by direct drawing dimension programming
0 : Normal specification
1 : A supplementary angle is given.
- QLG** When the passing-point signal output function is used, the remaining distance to be traveled specified in address "Q" is:
0 : The combined distance of all axes
1 : The distance of the longest axis

NOTE

This parameter is valid when bit 7 (QAB) of parameter No.3405 = 0.

- QAB** When the passing-point signal output function is used, address "Q" specifies:
0 : Remaining distance to be traveled
1 : Coordinate value of the longest axis

	#7	#6	#5	#4	#3	#2	#1	#0
3406	C07		C05	C04	C03	C02	C01	
	C07		C05	C04	C03	C02	C01	
3407		C14			C11	C10		C08
	C15	C14	C13		C11	C10	C09	C08
3408								C16
				C20	C19	C18	C17	C16
3409	CFH							
	CFH							C24

[Data type] Bit

Cxx (xx: 01 to 24) When bit 6 (CLR) of parameter No.3402 is 1, the reset button on the MDI panel, the external reset signal, the reset and rewind signal, or emergency stop will,

0 : Clear the G code with group number xx.

1 : Not clear the G code with group number xx.

CFH When bit 6 (CLR) of parameter No.3402 is 1, the reset button on the MDI panel, the external reset signal, the reset and rewind signal, or emergency stop will,

0 : Clear F codes, H codes (for the M series), D codes (for the M series), and T codes (for the T series).

1 : Not clear F codes, H codes (for the M series), D codes (for the M series), and T codes (for the T series).

3410	Tolerance of arc radius
------	-------------------------

[Data type] 2-word**[Unit of data]**

Increment system	IS-A	IS-B	IS-C	Unit
Millimeter input	0.01	0.001	0.0001	mm
Inch input	0.001	0.0001	0.00001	inch

[Valid data range] 1 to 99999999

When a circular interpolation command (G02, G03) is executed, the tolerance for the radius between the start point and the end point is set. If the difference of radii between the start point and the end point exceeds the tolerance set here, a P/S alarm No.20 is informed.

NOTE

When the set value is 0, the difference of radii is not checked. In the HPCC mode, a check is made for a difference in the arc radius even if the set value is "0" (with allowable limit = 0).

3411	M code preventing buffering 1
3412	M code preventing buffering 2
3413	M code preventing buffering 3
:	:
3420	M code preventing buffering 10

[Data type] Byte

[Valid data range] 0 to 255

Set M codes that prevent buffering the following blocks. If processing directed by an M code must be performed by the machine without buffering the following block, specify the M code.

M00, M01, M02, and M30 always prevent buffering even when they are not specified in these parameters.

3421	Minimum value 1 of M code preventing buffering
3422	Maximum value 1 of M code preventing buffering
3423	Minimum value 2 of M code preventing buffering
3424	Maximum value 2 of M code preventing buffering
3425	Minimum value 3 of M code preventing buffering
3426	Maximum value 3 of M code preventing buffering
3427	Minimum value 4 of M code preventing buffering
3428	Maximum value 4 of M code preventing buffering
3429	Minimum value 5 of M code preventing buffering
3430	Maximum value 5 of M code preventing buffering
3431	Minimum value 6 of M code preventing buffering
3432	Maximum value 6 of M code preventing buffering

[Data type] Word

[Valid data range] 0 to 65535

When a specified M code is within the range specified with parameter Nos. 3421 and 3422, 3423 and 3424, 3425 and 3426, 3427 and 3428, 3429 and 3430, or 3431 and 3432, buffering for the next block is not performed until the execution of the block is completed.

NOTE

- 1 The specification of a minimum value that exceeds the specified maximum value is invalid.
- 2 When there is only one data item, set the following: minimum value = maximum value.

3441	First of the M codes assigned to item numbers 100 to 199
3442	First of the M codes assigned to item numbers 200 to 299
3443	First of the M codes assigned to item numbers 300 to 399
3444	First of the M codes assigned to item numbers 400 to 499

[Data type] 2–word

[Valid data range] 0 to 99999999

The M code group check function checks if a combination of up to three M codes specified in a block is valid, and the function issues an alarm if an invalid combination is detected. Before this function can be used, up to 500 M codes must be divided into no more than 128 groups. A set number from 0 to 499 is assigned to each of the 500 M codes. The group to which each M code with a set number assigned belongs is specified using the M code group setting screen.

The set numbers 0 to 499 correspond to M000 to M499. These parameters allow arbitrary M codes to be assigned in units of 100 M codes to the set numbers 100 to 499.

Parameter No.3441: Sets the M codes corresponding to the set numbers 100 to 199.

Parameter No.3442: Sets the M codes corresponding to the set numbers 200 to 299.

Parameter No.3443: Sets the M codes corresponding to the set numbers 300 to 399.

Parameter No.3444: Sets the M codes corresponding to the set numbers 400 to 499.

Each parameter sets the M code that corresponds to the first of the set numbers allocated to the parameter, thus assigning 100 successive M codes. For example, when parameter No.3441 = 10000 is set, the M codes corresponding to the set numbers 100 to 199 are M10000 to M10099.

NOTE

- 1 When the value 0 is set in a parameter, the specification of 100 added to the value of the previous parameter is assumed. For example, when No.3441=10000, and No.3442=0 are specified:

The M codes corresponding to the set numbers 100 to 199 are: M10000 to M10099

The M codes corresponding to the set numbers 200 to 299 are: M10100 to M10199

Specifying 0 for parameter No.3441 has the same effect as specifying for parameter No.3441 = 100.

- 2 When a is specified for parameter No.3441, b is specified for parameter No.3442, c is specified for parameter No.3443, and d is specified for parameter No.3444, the following relationships must be satisfied:

$a + 99 < b$, $b + 99 < c$, $c + 99 < d$

	#7	#6	#5	#4	#3	#2	#1	#0
3450				NPS	CQD			
	BDX				CQD			AUP

[Data type] Bit

- AUP** When a command for the second miscellaneous function contains a decimal point or negative sign:
 0 : The command is invalid.
 1 : The command is valid.

NOTE

For the T series, a decimal point and negative sign are supported for commands for the second miscellaneous function, regardless of the setting made with this parameter.

- CQD** The method used for determining the amount of travel in circular interpolation is:
 0 : Series 16 type.
 1 : Series 15 type.
- NPS** A block that contains M98 Pxxx or M99, and which contains no addresses other than O and N functions:
 0 : As a one-block NC statement involving no movement.
 (A single-block stop is caused.)
 1 : As a macro statement.
 (A single-block stop is not caused. Moreover, the block is not regarded as a block involving no movement in tool-tip radius compensation mode.)
- BDX** A decimal point specified with address B is handled:
 0 : In the conventional way.
 1 : In the same way as in a system equipped with the second auxiliary function.

In a system without second auxiliary function, the decimal point specified with address B can be handled as in a system equipped with the second auxiliary function. The following parameters can be used:

- Bit 0 (AUP) of parameter No. 3450
- Bit 0 (AUX) of parameter No. 3405

	#7	#6	#5	#4	#3	#2	#1	#0
3451								
				NBN	CCK	SDP		GQS

[Data type] Bit

- GQS** When G33 is specified, the threading start angle shift function (Q) is:
 0 : Disabled.
 1 : Enabled.

- SDP** The function to specify an S command with decimal point is:
 0 : Not used.
 1 : Used.

An S command with one decimal place can be specified. However, the S command value is rounded off to the nearest whole number.

Example: Relationships between specified value and S code output/alarm

S200.5 → S code output value = 201

S200.2 → S code output value = 200

S200.12 → P/S007 alarm is raised.

CCK If chamfering or corner R is enabled and if the end point specified in an arc command is not complete,

0 : No alarm is raised.

1 : An alarm (P/S058 alarm) is raised.

This parameter specifies whether an alarm is raised if chamfering or corner R is enabled, if the end point specified in an arc command is not complete, and if an address is omitted.

If the end point is omitted in an arc command, chamfering or corner R may affect the omitted point, and the operation may not be performed as intended by the programmer. If this parameter is specified, an alarm can be raised for that type of program execution.

NBN If bit 0 (NOP) of parameter No. 3404 is set to 1, a block including just N (sequence number) is:

0 : Ignored.

1 : Not ignored but handled as a single block.

	#7	#6	#5	#4	#3	#2	#1	#0
3453								CRD

[Data type] Bit

CRD If the functions of chamfering or corner R and direct drawing dimension programming are both enabled,

0 : Chamfering or corner R is enabled.

1 : Direct drawing dimension programming is enabled.

If the functions of chamfering or corner R and direct drawing dimension programming are both specified, this parameter specifies which function is used.

This parameter is displayed also on the setting screen. (“CHAMFERING/DIRECT DRAWING DIMENSION PROGRAMMING”) The function to be enabled can be changed from the setting screen or parameter screen.

	#7	#6	#5	#4	#3	#2	#1	#0
3455								
								AXD

[Data type] Bit axis

AXD If a decimal point is omitted for an address with which a decimal point can be used, the value is determined:

0 : In accordance with the least input increment.

1 : In millimeters, inches, or seconds. (calculator-type decimal point input)

NOTE

1 This parameter is valid if bit 0 (DPI) of parameter No. 3401 is set to 0.

2 Because some addresses (such as R and K) are not related to an axis, setting this parameter for all axes is not equivalent to setting bit 0 (DPI) of parameter No. 3401 to 1.

3460	
	Address for second miscellaneous function

[Data type] Byte

This parameter specifies the address used for the second miscellaneous function, as follows:

Address	A	B	C	U	V	W
Set value	65	66	67	85	86	87

Address B is assumed when a value other than the above is set.

Axes names cannot be used to specify the address.

3471	
	Allowed difference between the specified end position and the end position obtained from the increase/decrease and frequency in spiral interpolation or conic interpolation

[Data type] 2-word axis

[Unit of data]

Increment system	IS-A	IS-B	IS-C	Units
Millimeter input	0.01	0.001	0.0001	mm
Inch input	0.001	0.0001	0.00001	inch

[Valid data range] 0 to 99999999

This parameter sets the maximum allowable difference (absolute value) between the specified end position and the end position obtained from the increase/decrease and frequency in spiral or conic interpolation.

3472	
	Minimum radius needed to maintain the actual speed in spiral or conic interpolation

[Data type] 2-word

[Unit of data]

Increment system	IS-A	IS-B	IS-C	Units
Millimeter input	0.01	0.001	0.0001	mm
Inch input	0.001	0.0001	0.00001	inch

[Valid data range] 1000 to 99999999 (metric input)
10000 to 99999999 (inch input)

If this parameter value is 0 or a value outside the valid data range, the minimum value of the range is assumed.

In spiral interpolation and conic interpolation, the speed is generally held constant. In an area near the center, the spiral radius decreases, resulting in an extremely high angular velocity. To prevent this, once the spiral radius has reached the parameter-set value, the angular velocity subsequently remains constant. As a result, the actual speed decreases.

4.22 PARAMETERS OF PITCH ERROR COMPENSATION

	#7	#6	#5	#4	#3	#2	#1	#0
3601							EPC	

NOTE

When this parameter has been set, the power must be turned off before operation is continued.

[Data type] Bit

EPC The pitch error compensation on an axis of Cs contour control on the slave side during simple synchronous spindle control is:
 0 : The same as that on the master axis.
 1 : Just for the slave axis.

To use unique pitch error compensation, set a pitch error compensation data number in parameters No. 3661 to 3674, and set the specified pitch error compensation data to desired unique pitch error compensation.

If bit 0 (BDP) of parameter No. 3605 is set to use both-direction pitch error compensation, set parameters No. 3676 to 3684 as well.

	#7	#6	#5	#4	#3	#2	#1	#0
3605								BDP

NOTE

When this parameter has been set, the power must be turned off before operation is continued.

[Data type] Bit

BDP Both-direction pitch error compensation is:
 0 : Not used.
 1 : Used.

NOTE

The function of both-direction pitch error compensation is required.

3620	Number of the pitch error compensation position for the reference position for each axis
------	--

NOTE

When this parameter is set, the power must be turned off before operation is continued.

[Data type] Word axis

[Unit of data] Number

[Valid data range] 0 to 1023

Set the number of the pitch error compensation position for the reference position for each axis.

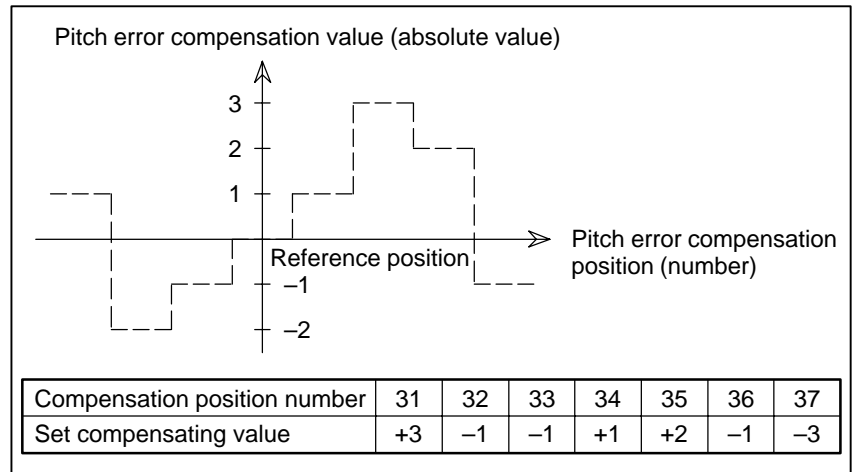

Fig.4.22 Pitch Error Compensation Position Number and Value (Example)

In the above example, set 33 as the number of the pitch error compensation position for the reference position.

3621	Number of the pitch error compensation position at extremely negative position for each axis
------	--

NOTE
When this parameter is set, the power must be turned off before operation is continued.

[Data type] Word axis

[Unit of data] Number

[Valid data range] 0 to 1023

Set the number of the pitch error compensation position at the extremely negative position for each axis.

3622	Number of the pitch error compensation position at extremely positive position for each axis
------	--

NOTE
When this parameter is set, the power must be turned off before operation is continued.

[Data type] Word axis

[Unit of data] Number

[Valid data range] 0 to 1023

Set the number of the pitch error compensation position at the extremely positive position for each axis.

This value must be larger than set value of parameter (No.3620).

3623

Magnification for pitch error compensation for each axis

NOTE

When this parameter is set, the power must be turned off before operation is continued.

[Data type] Byte axis

[Unit of data] 1

[Valid data range] 0 to 100

Set the magnification for pitch error compensation for each axis.

If the magnification is set to 1, the same unit as the detection unit is used for the compensation data. If 0 is set, the same magnification selected by setting 1 is selected.

3624

Interval between pitch error compensation positions for each axis

NOTE

When this parameter is set, the power must be turned off before operation is continued.

[Data type] 2-word axis

[Unit of data]

Increment system	IS-A	IS-B	IS-C	Unit
Millimeter machine	0.01	0.001	0.0001	mm
Inch machine	0.001	0.0001	0.00001	inch
Rotation axis	0.01	0.001	0.0001	deg

[Valid data range] 0 to 99999999

The pitch error compensation positions are arranged with equal spacing. The space between two adjacent positions is set for each axis. The minimum interval between pitch error compensation positions is limited and obtained from the following equation:

$$\text{Minimum interval between pitch error compensation positions} = \text{maximum feedrate (rapid traverse rate)} / 7500$$

Units: Minimum interval between pitch error compensation positions: mm, inch, deg

Maximum feedrate: mm/min, inch/min, deg/min

Example: When the maximum feedrate is 15000 mm/min, the minimum interval between pitch error compensation positions is 2 mm.

If setting a magnification causes the absolute value of the compensation amount at a compensation position to exceed 100, enlarge the interval between the compensation positions by using a multiple calculated as follows:

$$\text{Multiple} = \text{maximum compensation amount (absolute value)} / 128$$

(Round the remainder up to the nearest integer.)

$$\text{Minimum interval between pitch error compensation positions} = \text{Value obtained from the above maximum feedrate} \times \text{multiple}$$

Example 1) For linear axis

- Machine stroke: -400 mm to + 800 mm
- Interval between the pitch error compensation positions: 50 mm
- No.of the compensation position of the reference position: 40

If the above is specified, the No.of the farthest compensation point in the negative direction is as follows:

$$\begin{aligned} & \text{No.of the compensation position of the reference position} - (\text{Machine stroke length in the negative direction} / \text{Interval between the compensation points}) + 1 \\ & = 40 - 400/50 + 1 \\ & = 33 \end{aligned}$$

No.of the farthest compensation position in the positive direction is as follows:

$$\begin{aligned} & \text{No.of the compensation position of the reference position} + (\text{Machine stroke length in the positive direction} / \text{Interval between the compensation positions}) \\ & = 40 + 800/50 \\ & = 56 \end{aligned}$$

The correspondence between the machine coordinate and the compensation position No.is as follows:

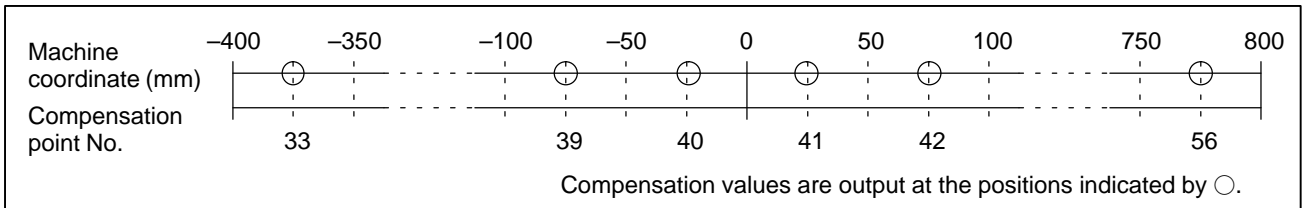

Therefore, set the parameters as follows:

Parameter	Setting
No. 3620: Compensation point number for reference position	40
No. 3621: Compensation point number for farthest point in the negative direction	33
No. 3622: Compensation point number for farthest point in the positive direction	56
No. 3623: Compensation magnification	1
No. 3624: Compensation point interval	50000

The compensation value is output at the compensationn position No.corresponding to each section between the coordinates.

The following is an example of the compensation values.

No.	33	34	35	36	37	38	39	40	41	42	43	44	45	46	47	48	49
Compensation values	+2	+1	+1	-2	0	-1	0	-1	+2	+1	0	-1	-1	-2	0	+1	+2

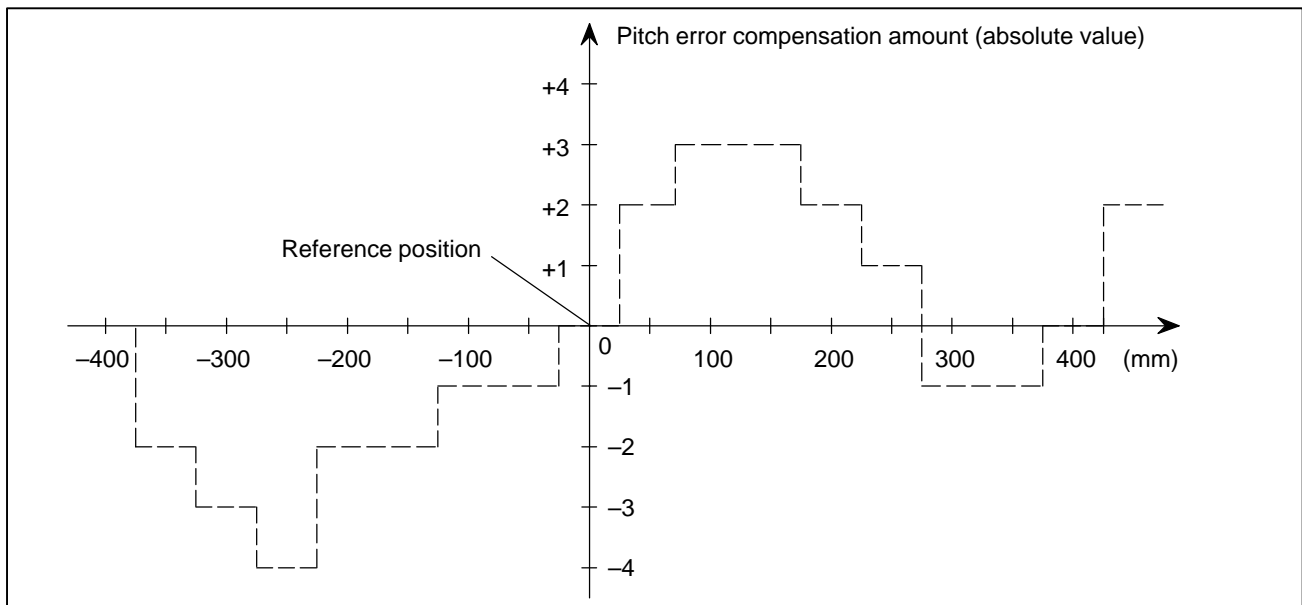

Example 2) For the rotation axis

- Amount of movement per rotation: 360°
- Interval between pitch error compensation position: 45°
- No. of the compensation position of the reference position: 60

If the above is specified, the No. of the farthest compensation position in the negative direction for the rotation axis is always equal to the compensation position No. of the reference position.

The No. of the farthest compensation position in the positive direction is as follows:

$$\begin{aligned} & \text{No. of the compensation position of the reference position} + (\text{Move} \\ & \text{amount per rotation} / \text{Interval between the compensation position}) \\ & = 60 + 360/45 \\ & = 68 \end{aligned}$$

The correspondence between the machine coordinate and the compensation position No. is as follows:

The compensation value is output at the circled position.

If the sum of the compensation value from 61 to 68 is not zero, the pitch error per rotation accumulates, resulting in a positional shift.

For compensation position 60, set the same compensation value as for 68.

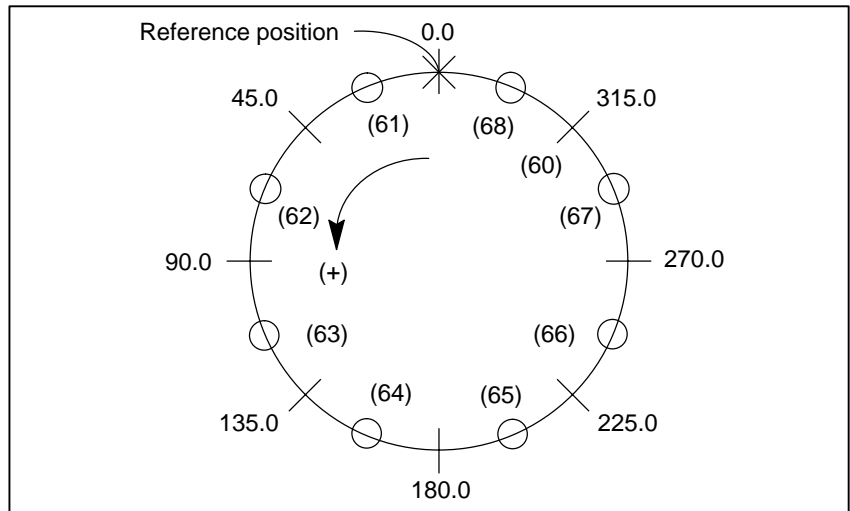

Set the parameters as follows:

Parameter	Setting
No. 3620: Compensation point number for reference position	60
No. 3621: Compensation point number for farthest point in the negative direction	60
No. 3622: Compensation point number for farthest point in the positive direction	68
No. 3623: Compensation magnification	1
No. 3624: Compensation point interval	45000

The following is an example of compensation values.

No. of the compensation position	60	61	62	63	64	65	66	67	68
Compensation value	+1	-2	+1	+3	-1	-1	-3	+2	+1

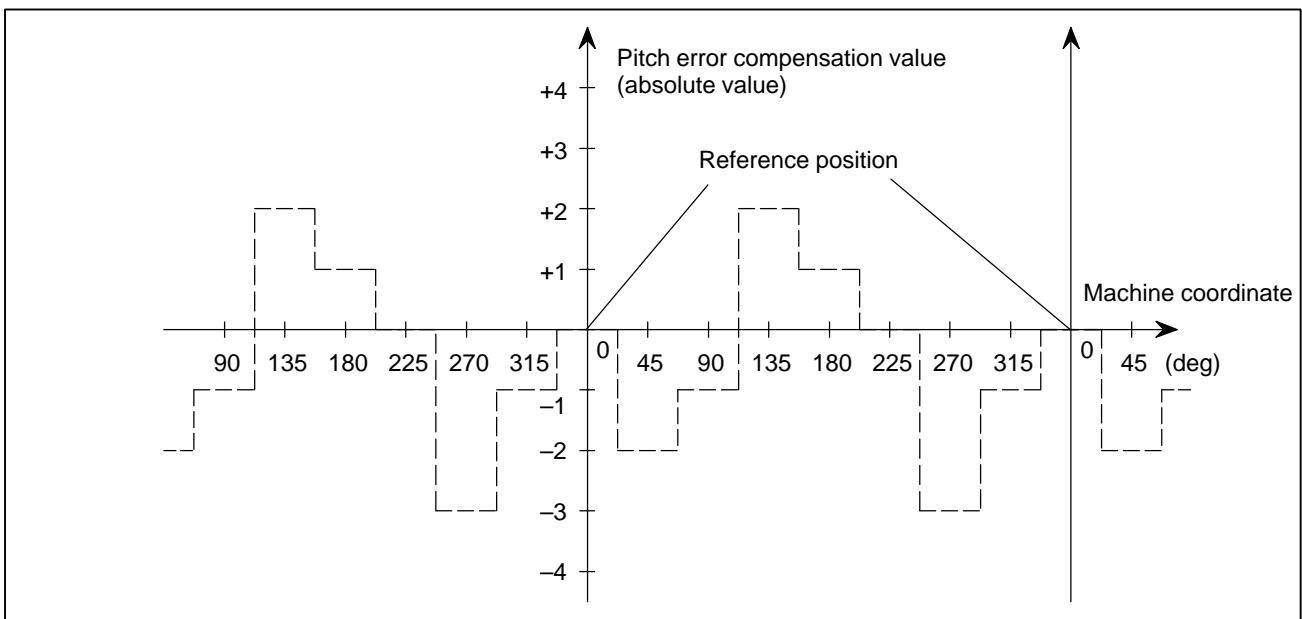

3625

Travel distance per revolution in pitch error compensation of rotation axis type

NOTE

When this parameter has been set, the power must be turned off before operation is continued.

[Data type] 2-word axis

[Valid data range] 0 to 99999999

If the pitch error compensation of rotation axis type is performed (bit 1 (ROsx) of parameter No. 1006 is set to 0 and bit 0 (ROTx) of parameter No. 1006 is set to 1), set the travel distance per revolution. The travel distance per revolution does not have to be 360 degrees, and a cycle of pitch error compensation of rotation axis type can be set.

However, the travel distance per revolution, compensation interval, and number of compensation points must satisfy the following condition:

$$(\text{Travel distance per revolution}) = (\text{Compensation interval}) \times (\text{Number of compensation points})$$

The compensation at each compensation point must be set so that the total compensation per revolution equals 0.

NOTE

If 0 is set, the travel distance per revolution becomes 360 degrees.

3626

Number of pitch error compensation point at the farthest end in the negative direction (for movement in the negative direction)

NOTE

When this parameter has been set, the power must be turned off before operation is continued.

[Data type] Word axis

[Unit of data] Number

[Valid data range] 0 to 1023, 3000 to 4023

When using both-direction pitch error compensation, set the number of pitch error compensation point at the farthest end in the negative direction for a movement in the negative direction.

NOTE

- 1 For a movement in the positive direction, set the compensation point number at the farthest end in the negative direction in parameter No. 3621.
- 2 A set of compensation data items for a single axis should not be set to lie astride 1023 and 3000.

3627	Pitch error compensation (absolute value) at reference position when a movement to the reference position is made from the direction opposite to the direction of reference position return
------	---

NOTE

When this parameter has been set, the power must be turned off before operation is continued.

[Data type] Word axis

[Unit of data] Detection unit

[Valid data range] -32768 to 32767

Set the absolute value of pitch error compensation at reference position when a movement to the reference position is made from the negative direction if the direction of reference position return (bit 5 (ZMI) of parameter No. 1006) is positive or from the positive direction if the direction of reference position return is negative.

3661	Number of pitch error compensation point in the reference position if pitch error compensation is carried out on an axis of Cs contour control on the slave side during simple synchronous spindle control (for the first spindle)

3662	Number of pitch error compensation point in the reference position if pitch error compensation is carried out on an axis of Cs contour control on the slave side during simple synchronous spindle control (for the second spindle)

3663	Number of pitch error compensation point in the reference position if pitch error compensation is carried out on an axis of Cs contour control on the slave side during simple synchronous spindle control (for the third spindle)

3664	Number of pitch error compensation point in the reference position if pitch error compensation is carried out on an axis of Cs contour control on the slave side during simple synchronous spindle control (for the fourth spindle)

3666	<p>Number of pitch error compensation point at the farthest end in the negative direction if pitch error compensation is carried out on an axis of Cs contour control on the slave side during simple synchronous spindle control (for the first spindle)</p>
3667	<p>Number of pitch error compensation point at the farthest end in the negative direction if pitch error compensation is carried out on an axis of Cs contour control on the slave side during simple synchronous spindle control (for the second spindle)</p>
3668	<p>Number of pitch error compensation point at the farthest end in the negative direction if pitch error compensation is carried out on an axis of Cs contour control on the slave side during simple synchronous spindle control (for the third spindle)</p>
3669	<p>Number of pitch error compensation point at the farthest end in the negative direction if pitch error compensation is carried out on an axis of Cs contour control on the slave side during simple synchronous spindle control (for the fourth spindle)</p>
3671	<p>Number of pitch error compensation point at the farthest end in the positive direction if pitch error compensation is carried out on an axis of Cs contour control on the slave side during simple synchronous spindle control (for the first spindle)</p>
3672	<p>Number of pitch error compensation point at the farthest end in the positive direction if pitch error compensation is carried out on an axis of Cs contour control on the slave side during simple synchronous spindle control (for the second spindle)</p>
3673	<p>Number of pitch error compensation point at the farthest end in the positive direction if pitch error compensation is carried out on an axis of Cs contour control on the slave side during simple synchronous spindle control (for the third spindle)</p>

3674	Number of pitch error compensation point at the farthest end in the positive direction if pitch error compensation is carried out on an axis of Cs contour control on the slave side during simple synchronous spindle control (for the fourth spindle)

NOTE

When this parameter has been set, the power must be turned off before operation is continued.

[Data type] Word

[Unit of data] Number

[Valid data range] 0 to 1023

This parameter is used if bit 1 (EPC) of parameter No. 3601 is set to 1, so that pitch error compensation is carried out on an axis of Cs contour control on the slave side during simple synchronous spindle control, separately from that on the master side. Set the pitch error compensation data number to be assigned to the parameter of the spindle which becomes the axis of Cs contour control on the slave side.

NOTE

The fourth spindle can be used just in Series 16*i*.

3676	Number of compensation point at the farthest end in the negative direction in a movement in the negative direction if both-direction pitch error compensation is carried out on an axis of Cs contour control on the slave side during simple synchronous spindle control (first spindle)

3677	Number of compensation point at the farthest end in the negative direction in a movement in the negative direction if both-direction pitch error compensation is carried out on an axis of Cs contour control on the slave side during simple synchronous spindle control (second spindle)

3678	Number of compensation point at the farthest end in the negative direction in a movement in the negative direction if both-direction pitch error compensation is carried out on an axis of Cs contour control on the slave side during simple synchronous spindle control (third spindle)

3679	Number of compensation point at the farthest end in the negative direction in a movement in the negative direction if both-direction pitch error compensation is carried out on an axis of Cs contour control on the slave side during simple synchronous spindle control (fourth spindle)

NOTE

When this parameter has been set, the power must be turned off before operation is continued.

[Data type] Word

[Unit of data] Number

[Valid data range] 0 to 1023, 3000 to 4023, 0 to 2599, 3000 to 5599

If both-direction pitch error compensation is used (bit 0 (BDP) of parameter No. 3605 is set to 1), set the number of the compensation point at the farthest end in the negative direction for a movement in the negative direction.

NOTE

- 1 This parameter is valid if pitch error compensation on an axis of Cs contour control on the slave side during simple synchronous spindle control is carried out just for the slave axis (bit 1 of parameter No. 3601 is set to 1).
- 2 The number of the compensation point at the farthest end in the negative direction for a movement in the positive direction is set in parameters No. 3666 to No. 3669.
- 3 A set of compensation data items for a single axis cannot be set to lie astride 1023 and 3000 or astride 2599 and 5599.
- 4 The fourth spindle can be used just in Series 16i.

3681	Pitch error compensation at the reference position if a movement to the reference position is made from the direction opposite to the direction of reference position return (first spindle)

3682	Pitch error compensation at the reference position if a movement to the reference position is made from the direction opposite to the direction of reference position return (second spindle)

3683	Pitch error compensation at the reference position if a movement to the reference position is made from the direction opposite to the direction of reference position return (third spindle)

3684	Pitch error compensation at the reference position if a movement to the reference position is made from the direction opposite to the direction of reference position return (fourth spindle)

NOTE

When this parameter has been set, the power must be turned off before operation is continued.

[Data type] Word

[Unit of data] Detection unit

[Valid data range] -32768 to 32767

This parameter is set if both-direction pitch error compensation is used in Cs contour control on the slave side during simple synchronous spindle control (bit 0 (BDP) of parameter No. 3605 is set to 1). Set the absolute value of pitch error compensation at the reference position when the movement is made in the negative direction if the direction of reference position return (bit 5 (ZMI) of parameter No. 1006) is positive or in the positive direction if the direction of reference position return is negative.

NOTE

- 1 This parameter is valid if pitch error compensation on an axis of Cs contour control on the slave side during simple synchronous spindle control is carried out just on the slave axis (bit 1 of parameter No. 3601 is set to 1).
- 2 The fourth spindle can be used just in Series 16*i*.

4.23 PARAMETERS OF SPINDLE CONTROL

	#7	#6	#5	#4	#3	#2	#1	#0
3700							NRF	

[Data type] Bit

NRF The first move command (such as G00 and G01) after the serial spindle is switched to Cs axis contouring control performs:
 0 : Positioning after returning to the reference position.
 1 : Normal positioning.

	#7	#6	#5	#4	#3	#2	#1	#0
3701			SS3	SS2			ISI	

NOTE
 When this parameter is set, the power must be turned off before operation is continued.

ISI The serial interface for the first and second spindles are:
 0 : Used.
 1 : Not used.

NOTE
 This parameter is valid when the spindle serial output option is provided. It is used when the CNC is started with serial interface control for the first and second serial spindles disabled temporarily (for example, for CNC startup adjustment). Usually, it should be set to 0.
 If the serial interface for the third serial spindle is disabled for the same reason, parameter SS3 (bit 5 of parameter No.3701) must be 0. (This parameter does not disable the serial interface of the third spindle.)
 If this parameter is set to 1 when using the serial spindle and analog spindle at the same time, the analog spindle is set the first axis.

SS2 In serial spindle control, the second spindle is:
 0 : Not used.
 1 : Used.

NOTE
 This parameter is valid, when the spindle serial output option is provided and parameter ISI(bit 1 of parameter No.3701)is 0.
 1 Confirmation of connection of the second serial spindle amplifier, and communication with it
 2 Control of the second spindle during asynchronous control (SIND2)
 When this parameter is set, it is also necessary to set the serial spindle parameter for the second spindle.

SS3 In serial spindle control, the third spindle is:
 0 : Not used.
 1 : Used.

NOTE

This parameter is valid, single-path control and the spindle output option and the three-spindle serial output option are provided.

Parameter setting			Serial spindles to be used
SS4 (No.3704#1)	SS3 (No.3701#5)	SS2 (No.3701#4)	
0	0	0	First spindle only
0	0	1	First and second spindles
0	1	0	First and third spindles
0	1	1	First to third spindles
1	1	0	First, third, and fourth spindles
1	1	1	First to fourth spindles

NOTE

- 1 To connect a serial spindle as the third or fourth spindle, the function of three/four-spindle serial output is required.
- 2 The fourth serial spindle can be used just in Series 16*i*.

	#7	#6	#5	#4	#3	#2	#1	#0
3702	ECS	ESS	EAS	ESI	OR2	OR1	EMS	OR3
	ECS	ESS	EAS		OR2	OR1	EMS	OR3

NOTE

When this parameter is set, the power must be turned off before operation is continued.

[Data type] Bit

OR3 The spindle orientation function based on an externally set stop position is:
 0 : Not used by the third spindle motor.
 1 : Used by the third spindle motor.

NOTE

When the spindle orientation function based on an externally set stop position is used, the position coder-based spindle orientation stop position set parameters (No.4031 and No.4204) are ineffective.

EMS Multi-spindle control function
 0 : Used
 1 : Not used

NOTE

If the multi-spindle control function is not required for one path in two-path control, specify this parameter for the path to which the multi-spindle control function need not be applied.

OR1 Whether the stop-position external-setting type orientation function is used by the first spindle motor

- 0 : Not used
- 1 : Used

OR2 Whether the stop-position external-setting type orientation function is used by the second spindle motor

- 0 : Not used
- 1 : Used

ESI The spindle positioning function is

- 0 : Used
- 1 : Not used

NOTE

This parameter is used when the spindle positioning option specified with two-path control, and the spindle positioning function is not required for either path. Set ESI to 1 for a system that does not require the spindle positioning function.

EAS For path 1 (or path 2), the S analog output function is:

- 0 : Used.
- 1 : Not used.

ESS For path 1 (or path 2), the S serial output function is:

- 0 : Used.
- 1 : Not used.

ECS For path 1 (or path 2), the Cs contour control function is:

- 0 : Used.
- 1 : Not used.

NOTE

Parameter EAS, ESS, and ECS are used for 2-path control.

These parameters are used to determine whether the optional function, S analog output function, S serial output function, and Cs contour control function, are used for each tool post.

	#7	#6	#5	#4	#3	#2	#1	#0
3703					MPP	3SP	RSI	2SP

NOTE

When this parameter is set, the power must be turned off before operation is continued.

[Data type] Bit

2SP Specifies whether one or two spindles are controlled (2-path control).

- 0 : One spindle (two tool posts)
- 1 : Two spindle (two tool posts)

RSI Spindle command selection for 2-path control :

- 0 : Affects commands from SIND for the first spindle
- 1 : Does not affect commands from SIND for the first spindle
(Spindle commands from SIND always control spindles in the same path, regardless of spindle command selection signals SLSPA and SLSPB <G063 bits 2 and 3>.)

3SP Spindle control setting in three-path control

- 0 : One-spindle or two-spindle control (Spindle control is not performed on the third tool post.)
- 1 : Three-spindle control (The spindles are individually controlled on the first to third tool posts.)

The selection of one-spindle or two-spindle control depends on the setting of bit 0 (2SP) of parameter No. 3703.

Under three-path control, spindle control is performed as indicated below.

2SP	3SP	Spindle control
0	0	Three-path one-spindle control
1	0	Three-path two-spindle control
0	1	Three-path three-spindle control
1	1	Three-path three-spindle control

MPP Under multi-spindle control, the spindle is not selected by a spindle signal (SWS1 to SWS4 <G027 bits 0 to 2, G026 bit 3>, SLSPA/SLSPB <G063 bits 2 and 3>), and a programmed command (address P) is:

- 0 : Not used.
- 1 : Used.

NOTE

If this parameter is set to 1, set parameters No. 3781 to No. 3784 as well.

	#7	#6	#5	#4	#3	#2	#1	#0
3704	CSS	PCS	SSY	SSS		OR4	SS4	

NOTE

When this parameter has been set, the power must be turned off before operation is continued.

[Data type] Bit

SS4 Under serial spindle control, the fourth serial spindle is:

- 0 : Not used.
- 1 : Used.

Bit 5 (SS3) and bit 4 (SS2) of parameter No. 3701 and this parameter specify the number of spindles to be connected.

See the table added to the description of bit 5 (SS3) and bit 4 (SS2) of parameter No. 3701.

NOTE

- 1 To use the fourth serial spindle, the third serial spindle is required.
- 2 The fourth serial spindle can be used just in Series 16*i*.

- OR4** For the fourth serial spindle, the function for controlling the spindle orientation of the stop position external setting type is:
 0 : Not used.
 1 : Used.

NOTE

The fourth serial spindle can be used just in Series 16*i*.

- SSS** Synchronous spindle control by each spindle is:
 0 : Not performed.
 1 : Performed.

The master axis and slave axis of synchronous spindle control can be selected from the first to fourth spindles.

The target spindle of synchronous spindle control is specified in parameters No. 4831 to 4834.

In addition, the following signals affect the control.

Synchronous spindle signal of each spindle
 SPSYC1 to SPSYC4 <G288 bits 0 to 3>

Signal of synchronous control of the spindle phase for each spindle
 SPPHS1 to SPPHS4 <G289 bits 0 to 3>

NOTE

The fourth spindle can be used just in Series 16*i*.

- SSY** Simple synchronous spindle control by each spindle is:
 0 : Not performed.
 1 : Performed.

The master axis and slave axis of simple synchronous spindle control can be selected from the first to fourth spindles.

The target spindle of simple synchronous spindle control is set in parameters No. 4821 to No. 4824.

In addition, the following signals affect the control.

Signal of simple synchronous control of each spindle
 ESSYC1 to ESSYC4 <G264 bits 0 to 3>

Parking signal of simple synchronous control of each spindle
 PKESE1 to PKESE4 <G265 bits 0 to 3>

NOTE

The fourth serial spindle can be used just in Series 16*i*.

PCS If the third or fourth serial spindle is connected under multi-spindle control, the third or fourth position coder selection signal (PC3SLC, PC4SLC <G026 bits 0 and 1>) is:
 0 : Not used.
 1 : Used.

NOTE

If the position coder feedback is exchanged between paths under multipath control of T series (spindle feedback selection signals SLPCA and SLPCB <G064 bits 2 and 3>), set this parameter to the same setting for the paths.
 The fourth serial spindle can be used just in Series 16i.

CSS On the second to fourth spindles, Cs contour control is:
 0 : Not performed.
 1 : Performed.

If Cs contour control is performed on each spindle as specified by this parameter, set parameter No. 1023 as indicated below.

Setting

- 1 = Axis of Cs contour control by the first spindle
- 2 = Axis of Cs contour control by the second spindle
- 3 = Axis of Cs contour control by the third spindle (Series 16i/18i only)
- 4 = Axis of Cs contour control by the fourth spindle (Series 16i only)

NOTE

- 1 A single spindle cannot be specified as multiple axes of Cs contour control.
- 2 Under multipath control, a spindle of another path cannot be assigned.
- 3 This parameter cannot be used with the spindle positioning function. When using the spindle positioning function, set bit 7 (CSS) of parameter No. 3704 to 0.

	#7	#6	#5	#4	#3	#2	#1	#0
3705				EVS				ESF
		SFA	NSF		SGT	SGB	GST	ESF

[Data type] Bit

ESF When the spindle control function (Spindle analog output or Spindle serial output) is used, and the constant surface speed control function is used or bit 4 (GTT) of parameter No.3705 is set to 1:
 0 : S codes and SF are output for all S commands.
 1 : S codes and SF are not output for an S command in constant surface speed control mode (G96 mode) or for an S command used to specify maximum spindle speed clamping (G50S—;).

NOTE

For the T series, this parameter is enabled when bit 4 (EVS) of parameter No.3705 is set to 1.

For the M series, SF is not output:

- (1) For an S command used to specify maximum spindle speed clamping (G92S—;) in constant surface speed control mode
- (2) When bit 5 (NSF) of parameter No.3705 is set to 1

GST The SOR signal is used for:

- 0 : Spindle orientation
- 1 : Gear shift

NOTE

If the function of constant surface speed control or bit 4 (GTT) of parameter No. 3706 is specified, this parameter is invalid.

SGB Gear switching method

- 0 : Method A (Parameters 3741 to 3743 for the maximum spindle speed at each gear are used for gear selection.)
- 1 : Method B (Parameters 3751 and 3752 for the spindle speed at the gear switching point are used for gear selection.)

SGT Gear switching method during tapping cycle (G84 and G74)

- 0 : Method A (Same as the normal gear switching method)
- 1 : Method B (Gears are switched during tapping cycle according to the spindle speed set in parameters 3761 and 3762).

EVS When the spindle control function (Spindle analog output or Spindle serial output) is used, S codes and SF are:

- 0 : Not output for an S command.
- 1 : Output for an S command.

NOTE

The output of S codes and SF for an S command in constant surface speed control mode (G96), or for an S command used to specify maximum spindle speed clamping (G50S—;) depends on the setting of bit 0 (ESF) of parameter No.3705.

NSF If the function of constant surface speed control is specified or if bit 4 (GTT) of parameter No. 3706 is set to 1 and when an S code is specified,

- 0 : SF is output.
- 1 : SF is not output.

SFA The SF signal is output:

- 0 : When gears are switched.
- 1 : Irrespective of whether gears are switched.

3706	#7	#6	#5	#4	#3	#2	#1	#0
	TCW	CWM	ORM		PCS		PG2	PG1
	TCW	CWM	ORM	GTT			PG2	PG1

[Data type] Bit

PG2 and PG1 Gear ratio of spindle to position coder

Magnification	PG2	PG1
×1	0	0
×2	0	1
×4	1	0
×8	1	1

$$\text{Magnification} = \frac{\text{Number of spindle revolutions}}{\text{Number of position coder revolutions}}$$

PCS When multi-spindle control is applied to two tool posts in two-path control, this parameter specifies whether a position coder feedback signal from the other tool post is selectable, regardless of the state of the PC2SLC signal (bit 7 of G028/bit 7 of G1028) of the other tool post:
 0 : Not selectable.
 1 : Selectable. (To select a position coder for the other tool post, the SLPCA signal (bit 2 of G064) and the SLPCB signal (bit 3 of G064) are used.)

NOTE
 Multi-spindle control based on the same serial spindle must be applied to both tool posts.

GTT Selection of a spindle gear selection method
 0: Type M.
 1 : Type T.

NOTE
 1 Type M:
 The gear selection signal is not entered. In response to an S command, the CNC selects a gear according to the speed range of each gear specified beforehand in parameters. Then the CNC reports the selection of a gear by outputting the gear selection signal. The spindle speed corresponding to the gear selected by the gear selection signal is output.
 Type T:
 The gear selection signal is entered. The spindle speed corresponding to the gear selected by this signal is output.
 2 When the constant surface speed control option is selected, type T is selected, regardless of whether this parameter is specified.
 3 When type T spindle gear switching is selected, the following parameters have no effect:
 No.3705#2 SGB, No.3751, No.3752, No.3705#3 SGT, No.3761, No.3762, No.3705#6 SFA, No.3735, No.3736
 However, parameter No.3744 is valid.

ORM Voltage polarity during spindle orientation
 0 : Positive
 1 : Negative

TCW, CWM Voltage polarity when the spindle speed voltage is output

TCW	CWM	Voltage polarity
0	0	Both M03 and M04 positive
0	1	Both M03 and M04 negative
1	0	M03 positive, M04 negative
1	1	M03 negative, M04 positive

	#7	#6	#5	#4	#3	#2	#1	#0
3707			P42	P41			P22	P21

[Data type] Bit

P22 and P21 Gear ratio of spindle to second position coder

Magnification	P22	P21
×1	0	0
×2	0	1
×4	1	0
×8	1	1

$$\text{Magnification} = \frac{\text{Number of spindle revolutions}}{\text{Number of position coder revolutions}}$$

Set the gear ratio of spindle to position coder (for the fourth spindle)

Magnification	P42	P41
×1	0	0
×2	0	1
×4	1	0
×8	1	1

NOTE

This parameter is valid if the multi-spindle control function is provided and if bit 6 (PCS) of parameter No. 3704 is set to 1. This parameter is valid for Series 16i only.

	#7	#6	#5	#4	#3	#2	#1	#0
3708		TSO	SOC	SVD	SSP		SAT	SAR
		TSO	SOC	SVD	SSP			SAR

[Data type] Bit

SAR The spindle speed arrival signal is:

- 0 : Not checked
- 1 : Checked

SAT Check of the spindle speed arrival signal at the start of executing the thread cutting block

- 0 : The signal is checked only when SAR, #0 of parameter 3708, is set.
- 1 : The signal is always checked irrespective of whether SAR is set.

NOTE

When thread cutting blocks are consecutive, the spindle speed arrival signal is not checked for the second and subsequent thread cutting blocks.

- SSP** The spindle speed read window (No. 138) reads the speed of the spindle:
 0 : Specified by the spindle feedback selection signal SLPCA or SLPCB <G064 bit 2 or 3>.
 1 : Of the path if the SPW signal <G195 bit 0> is set to 1.

 This parameter is used, for instance, to read the speed of a specific spindle by the window (No. 138), not depending on the actual control.
- SVD** When the SIND signal is on, the detection of spindle speed fluctuation is:
 0 : Disabled
 1 : Enabled
- SOC** During constant surface speed control (G96 mode), the speed clamp by the maximum spindle speed clamp command (M series: G92 S_; T series: G50 S_) is carried out:
 0 : Before spindle speed override.
 1 : After spindle speed override.

 If this parameter is set to 0, the spindle speed may exceed the maximum spindle speed (numeric value following S in G92 S_; (M series) or G50 S_; (T series)).
 If this parameter is set to 1, the spindle speed is limited to the maximum spindle speed.
 The spindle speed is limited to the upper limit of spindle speed specified in parameter No. 3772, irrespective of the setting of this parameter.
- TSO** During a threading or tapping cycle, the spindle override is:
 0 : Disabled (tied to 100%).
 1 : Enabled.

NOTE
 During rigid tapping, the override is tied to 100%, irrespective of the setting of this parameter.

	#7	#6	#5	#4	#3	#2	#1	#0
3709					MRS	MSI	RSC	SAM
			SMC			MSI	RSC	

[Data type] Bit

- SAM** The sampling frequency to obtain the average spindle speed
 0 : 4 (Normally, set to 0.)
 1 : 1
- RSC** In the constant surface speed control mode, the surface speed of a rapid traverse block is calculated:
 0 : In accordance with the coordinates of the end point.
 1 : In accordance with the current value, as in cutting feed.
- MSI** In multi-spindle control, the SIND signal is valid
 0 : Only when the first spindle is valid (SIND signal for the 2nd, 3rd spindle becomes ineffective)
 1 : For each spindle irrespective of whether the spindle is selected (Each spindle has its own SIND signal).

MRS Actual spindle speed signals and S 12-bit code signals to be output when multi-spindle control is performed

0 : Signals common to the first and second spindles are used, and the signals for the spindle selected by the spindle selection signal are output.

1 : Separate signals are output to the first and second spindles.

Signal	When MRS is 0	When MRS is 1
Actual spindle speed signals AR0 to AR15 (F040, F041)	First spindle Second spindle	First spindle
S 12-bit code signals R010 to R120 (F036, F037)	First spindle Second spindle	First spindle
Actual spindle speed signals AR20 to AR215 (F202, F203)	–	Second spindle
S12-bit code signals R0102 to R1202 (F200, F201)	–	Second spindle

SMC The function to check a large S command is:

0 : Not used.

1 : Used.

If a spindle gear of M type is selected, this function compares the specified S value and the settings of parameters No. 3741 to No. 3743 and raises an alarm if the S value is greater.

If this function is used, specifying an S value larger than the settings of parameters No. 3741 to No. 3743 causes P/S alarm 5310 to be raised.

NOTE

This function cannot be used together with any of bit 4 (GTT) of parameter No. 3706, constant surface speed control, or multi-spindle control.

3711	#7	#6	#5	#4	#3	#2	#1	#0
								CDM

NOTE

When this parameter is set, the power must be turned off before operation is continued.

[Data type] Bit

CDM The axis of Cs contour control of this path is:

- 0 : Not set as a virtual Cs axis.
- 1 : Set as a virtual Cs axis.

By setting this parameter to 1 and setting the Cs axis in parameter No. 1023, a virtual Cs axis is added even if the actual Cs axis is not connected. This enables composite control, which replaces the virtual Cs axis with an actual Cs axis connected to another path, under multipath control.

NOTE

- 1 If this parameter is set to 1, an actual Cs axis cannot be connected in the same path.
- 2 When using a virtual Cs axis, set the Cs axis in parameter No. 1023, assuming that one virtual serial spindle is added. If an actual serial spindle is connected to the path in which the virtual Cs axis is used, set the following parameters as indicated in the table below, depending on the number of spindles.

Actual spindle connected to the path	No.1023	No.3704#7 (CSS)
No spindle	-1	0
First spindle	-2	1
First and second spindles	-3	1
First, second, and third spindles	-4	1

* The total number of actual connected spindles and the virtual Cs axis cannot exceed 4.

- 3 Set the parameters of feedrate and the like for the virtual Cs axis. The Cs axis need not be specified in the parameters of motor (No. 4000 to No. 4393).
- 4 When performing composite control of the Cs axis, set bit 1 (CZM) of parameter No. 8161 to 1 at the same time. To perform composite control, the axis recombination function is required.
- 5 When this parameter has been set, the power must be turned off then back on for the setting to become effective.

	#7	#6	#5	#4	#3	#2	#1	#0
3715								NSAx

[Data type] Bit axis

NSAx This parameter specifies an axis for which confirmation of the spindle speed reached signal (SAR) is unnecessary when a move command is executed for the axis. When a move command is issued only for an axis for which 1 is set in this parameter, the spindle speed reached signal (SAR) is not checked.

0 : Confirmation of SAR is necessary.

1 : Confirmation of SAR is unnecessary.

3730	Data used for adjusting the gain of the analog output of spindle speed
------	--

[Data type] Word

[Unit of data] 0.1 %

[Valid data range] 700 to 1250

Set data used for adjusting the gain of the analog output of spindle speed.

[Adjustment method]

- (1) Assign standard value 1000 to the parameter.
- (2) Specify the spindle speed so that the analog output of the spindle speed is the maximum voltage (10 V).
- (3) Measure the output voltage.
- (4) Assign the value obtained by the following equation to parameter No.3730.

$$\text{Set value} = \frac{10 \text{ (V)}}{\text{Measured data (V)}} \times 1000$$

- (5) After setting the parameter, specify the spindle speed so that the analog output of the spindle speed is the maximum voltage. Confirm that the output voltage is 10V.

NOTE

This parameter needs not to be set for serial spindles.

3731

Compensation value for the offset voltage of the analog output of the spindle speed

[Data type] Word**[Unit of data]** Velo**[Valid data range]** -1024 to+1024

Set compensation value for the offset voltage of the analog output of the spindle speed.

Set value = $-8191 \times \text{Offset voltage (V)} / 12.5$

[Adjustment method]

- (1) Assign standard value 0 to the parameter.
- (2) Specify the spindle speed so that the analog output of the spindle speed is 0.
- (3) Measure the output voltage.
- (4) Assign the value obtained by the following equation to parameter No.3731.

$$\text{Set value} = \frac{-8191 \times \text{Offset voltage (V)}}{12.5}$$

- (5) After setting the parameter, specify the spindle speed so that the analog output of the spindle speed is 0. Confirm that the output voltage is 0V.

NOTE

This parameter need not to be set for serial spindles.

3732

The spindle speed during spindle orientation or the spindle motor speed during spindle gear shift

[Data type] Word**[Valid data range]** 0 to 20000

Set the spindle speed during spindle orientation or the spindle motor speed during gear shift.

When GST, #1 of parameter 3705, is set to 0, set the spindle speed during spindle orientation in rpm.

When GST, #1 of parameter 3705, is set to 1, set the spindle motor speed during spindle gear shift calculated from the following formula.

For a serial spindle

$$\text{Set value} = \frac{\text{Spindle motor speed during spindle gear shift}}{\text{Maximum spindle motor speed}} \times 16383$$

For an analog spindle

$$\text{Set value} = \frac{\text{Spindle motor speed during spindle gear shift}}{\text{Maximum spindle motor speed}} \times 4095$$

3735	
	Minimum clamp speed of the spindle motor

[Data type] Word

[Valid data range] 0 to 4095

Set the minimum clamp speed of the spindle motor.

$$\text{Set value} = \frac{\text{Minimum clamp speed of the spindle motor}}{\text{Maximum spindle motor speed}} \times 4095$$

NOTE

If the function of constant surface speed control or bit 4 (GTT) of parameter No. 3706 is specified, this parameter is invalid.

3736	
	Maximum clamp speed of the spindle motor

[Data type] Word

[Valid data range] 0 to 4095

Set the maximum clamp speed of the spindle motor.

$$\text{Set value} = \frac{\text{Maximum clamp speed of the spindle motor}}{\text{Maximum spindle motor speed}} \times 4095$$

NOTE

If the function of constant surface speed control or bit 4 (GTT) of parameter No. 3706 is specified, this parameter is invalid.

In this case, the maximum clamp speed of spindle motor cannot be specified. However, the maximum spindle speed can be specified by the following parameters.

Parameter No.3772 (for the first axis)

Parameter No.3802 (for the second axis)

Parameter No.3882 (for the third axis)

Parameter No.3850 (for the fourth axis : only 16i)

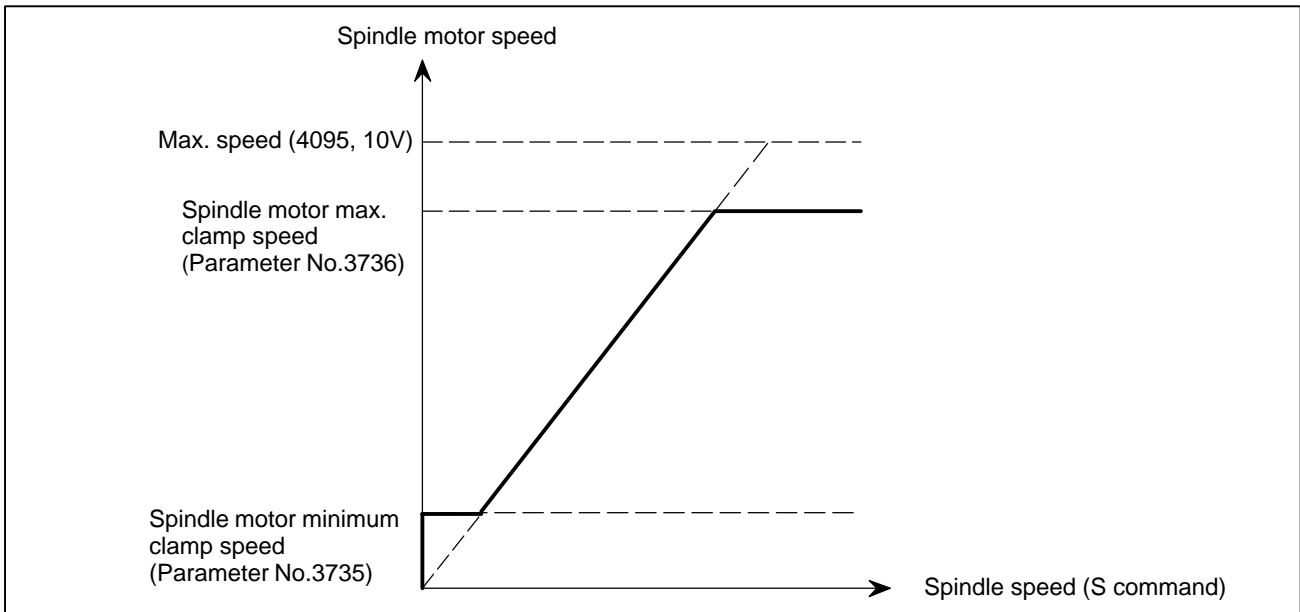

Fig.4.23 (a) Maximum Clamp Speed of Spindle Motor

3740	Time elapsed prior to checking the spindle speed arrival signal
------	---

[Data type] Byte

[Unit of data] msec

[Valid data range] 0 to 225

Set the time elapsed from the execution of the S function up to the checking of the spindle speed arrival signal.

3741	Maximum spindle speed for gear 1
3742	Maximum spindle speed for gear 2
3743	Maximum spindle speed for gear 3
3744	Maximum spindle speed for gear 4
	(Note)

[Data type] Two-word

[Unit of data] min⁻¹

[Valid data range] 0 to 32767

Set the maximum spindle speed corresponding to each gear.

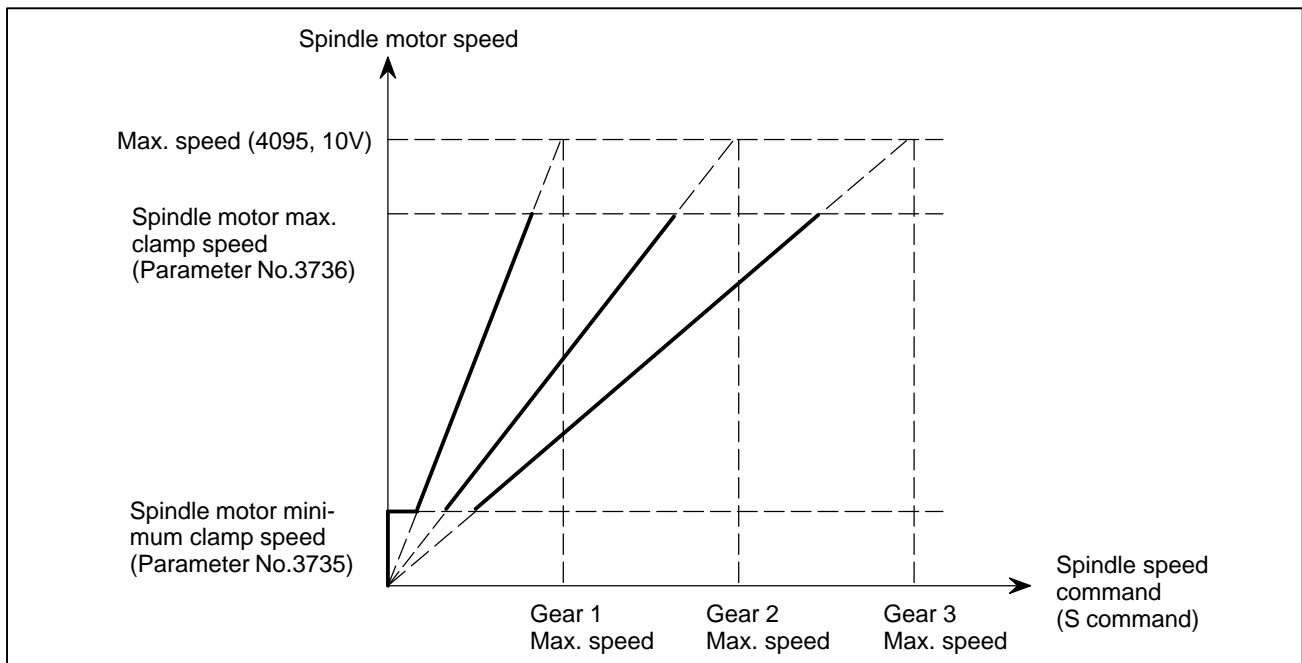

Fig.4.23 (b) Maximum Spindle Speed Corresponding to Gear 1/2/3

NOTE

If a type-T gear shift scheme is selected for the M series (with the constant surface speed control option installed or parameter GTT (bit 4 of parameter No. 3706) = 1), parameter No. 3744 is usable also in the M series. Note, however, that, even in this case, only up to three main gear stages are usable for rigid tapping.

3751	Spindle motor speed when switching from gear 1 to gear 2
------	--

3752	Spindle motor speed when switching from gear 2 to gear 3
------	--

[Data type] Word

[Valid data range] 0 to 4095

For gear switching method B, set the spindle motor speed when the gears are switched.

$$\text{Set value} = \frac{\text{Spindle motor speed when the gears are switched}}{\text{Maximum spindle motor speed}} \times 4095$$

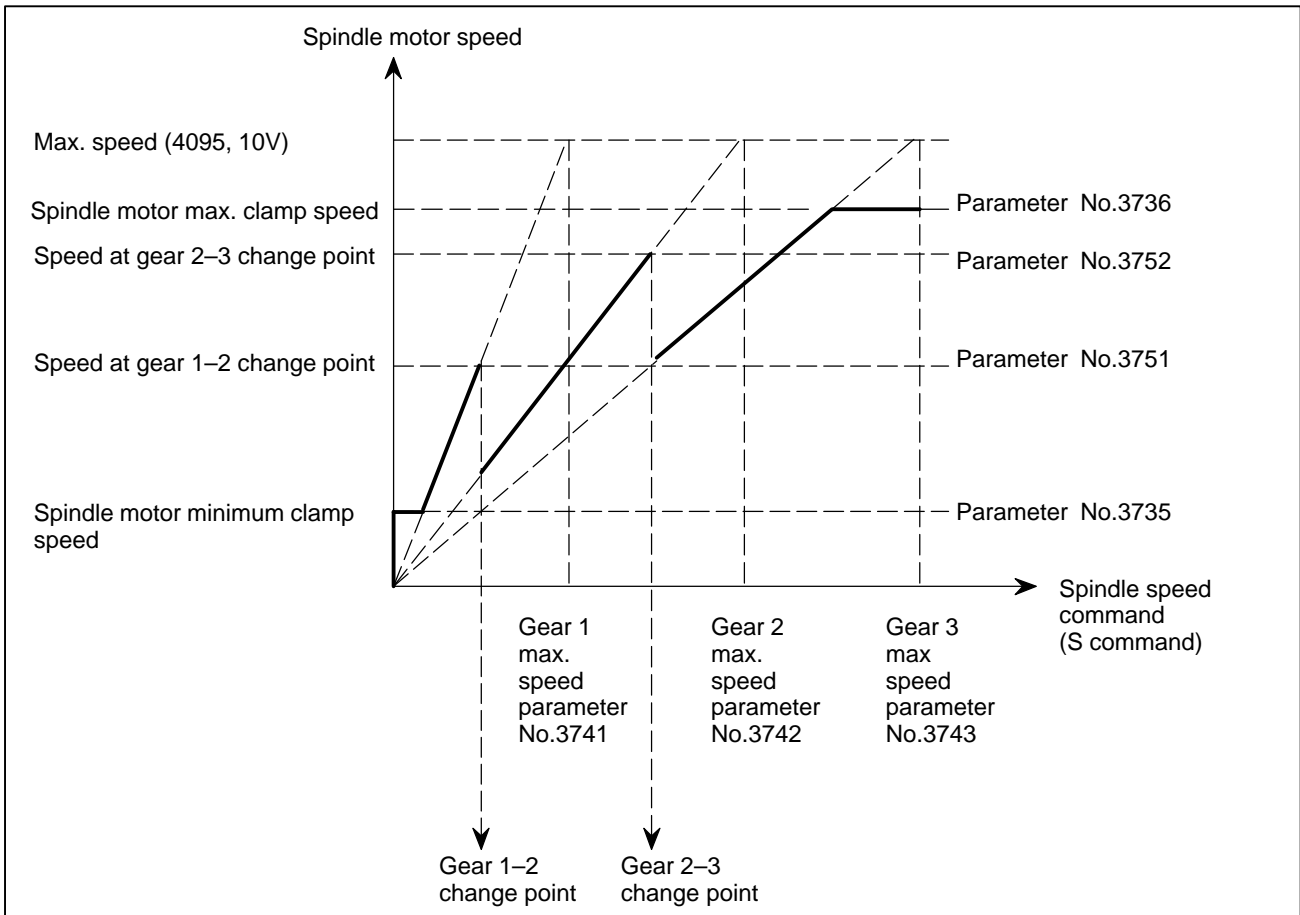

Fig.4.23 (c) Spindle Motor Speed at Gear 1-2/2-3 Change Point

3761	Spindle speed when switching from gear 1 to gear 2 during tapping
3762	Spindle speed when switching from gear 2 to gear 3 during tapping

[Data type] Word

[Unit of data] min⁻¹

[Valid data range] 0 to 32767

When method B is selected (SGT,#3 of parameter 3705, is set to 1) for the tapping cycle gear switching method, set the spindle speed when the gears are switched.

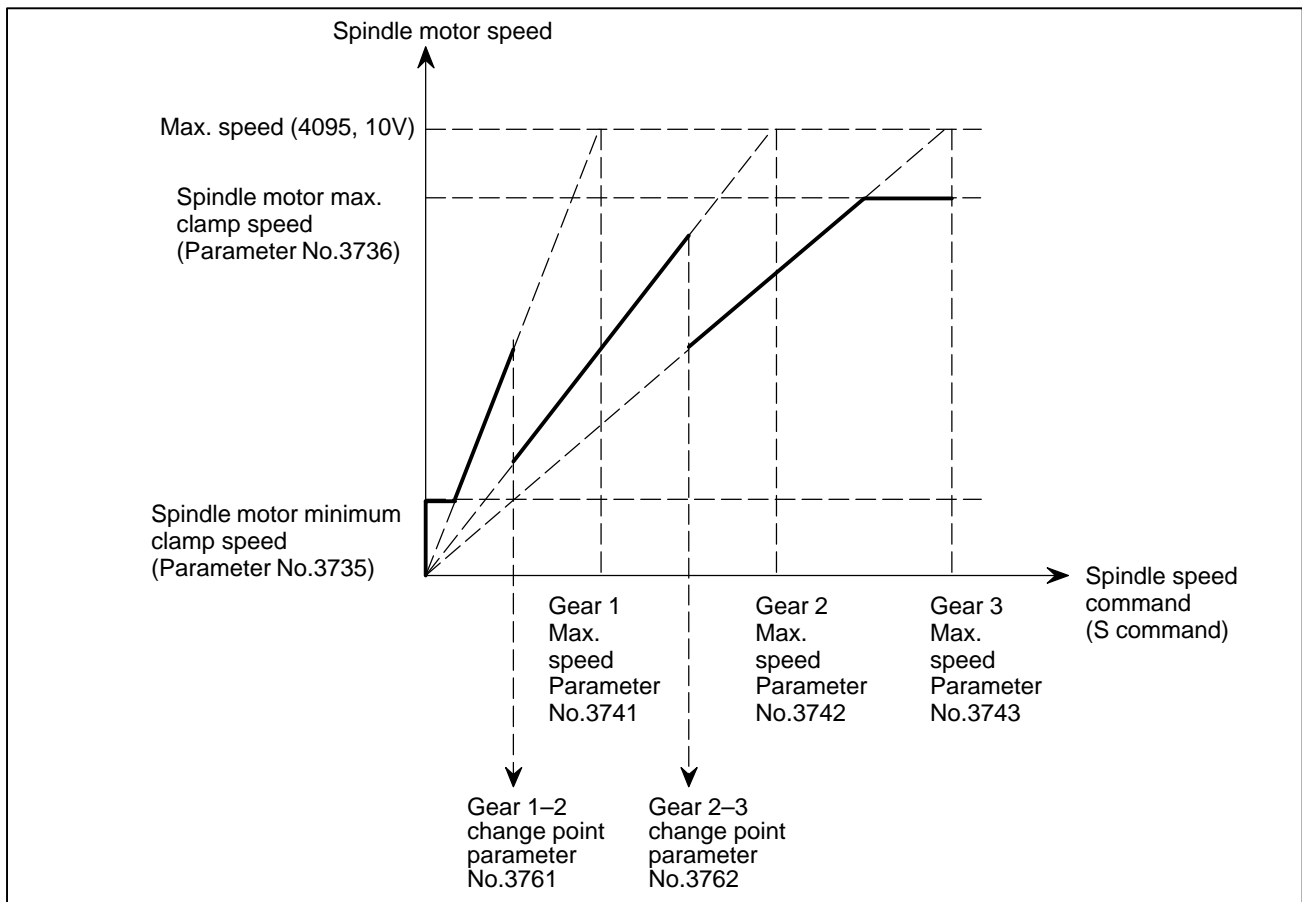

Fig.4.23 (d) Spindle Motor Speed at Gear 1-2/2-3 Change Point during Tapping

3770	Axis as the calculation reference in constant surface speed control
------	---

[Data type] Byte

[Valid data range] 1, 2, 3, ..., number of control axes

Set the axis as the calculation reference in constant surface speed control.

NOTE

When 0 is set, constant surface speed control is always applied to the X-axis. In this case, specifying P in a G96 block has no effect on the constant surface speed control.

3771	Minimum spindle speed in constant surface speed control mode (G96)
------	--

[Data type] Word

[Unit of data] min^{-1}

[Valid data range] 0 to 32767

Set the minimum spindle speed in the constant surface speed control mode (G96).

The spindle speed in constant surface speed control is clamped to the speed given by parameter 3771.

3772

Maximum spindle speed

[Data type] Word**[Unit of data]** min⁻¹**[Valid data range]** 0 to 32767

This parameter sets the maximum spindle speed.

When a command specifying a speed exceeding the maximum speed of the spindle is specified, or the speed of the spindle exceeds the maximum speed because of the spindle speed override function, the spindle speed is clamped at the maximum speed set in the parameter.

NOTE

- 1 For M series, this parameter is valid if the function of constant surface speed control is provided.
- 2 When the constant surface speed control option is selected, the spindle speed is clamped at the maximum speed, regardless of whether the G96 mode or G97 mode is specified.
- 3 When 0 is set in this parameter, the speed of the spindle is not clamped.
- 4 When spindle speed command control is applied using the PMC, this parameter has no effect, and the spindle speed is not clamped.
- 5 When the multi-spindle control option is selected (T series), set the maximum speed for each spindle in the following parameters:
 Parameter No.3772: Sets the maximum speed for the first spindle.
 Parameter No.3802: Sets the maximum speed for the second spindle.
 Parameter No.3822: Sets the maximum speed for the third spindle.

3781

P code for selecting the first spindle in multi-spindle control

3782

P code for selecting the second spindle in multi-spindle control

3783

P code for selecting the third spindle in multi-spindle control

3784

P code for selecting the fourth spindle in multi-spindle control

NOTE

When this parameter has been set, the power must be turned off before operation is continued.

[Data type] Word

[Valid data range] 0, 1 to 32767

If bit 3 (MPP) of parameter No. 3703 is set to 1, set the P code to select each spindle under multi-spindle control. Specify the P code in a block containing the S command.

Example) If the P code value for selecting the second spindle is set to 3, S1000 P3; causes the second spindle to rotate at S1000.

NOTE

- 1 This parameter is valid if bit 3 (MPP) of parameter No. 3703 is set to 1.
- 2 If this parameter is set to 0, the corresponding spindle cannot be selected by a P code.
- 3 Under multipath control, the P code specified here is valid for each path.
For instance, if the P code to select the first spindle of path 2 is set to 21, specifying S1000 P21; in path 1 causes the first spindle of path 2 to be rotated at S1000.
- 4 Identical P code values cannot be used for different spindles. (Identical P code values cannot be used even if the paths are different.)
- 5 If this parameter is used (bit 3 (MPP) of parameter No. 3703 is set to 1), signals SWS1 to SWS4 <G027 bits 0 to 2, G026 bit 3> and SLSPA/SLSPB <G063 bits 2 and 3> become invalid.
- 6 To use this parameter, the multi-spindle control function is needed.
- 7 Parameter No. 3784 is valid only for Series 16i.

3802	Maximum speed of the second spindle
------	-------------------------------------

[Data type] Word

[Unit of data] min⁻¹

[Valid data range] 0 to 32767

Parameter sets the maximum speed for the second spindle.

When a command specifying a speed exceeding the maximum speed of the spindle is specified, or the speed of the spindle exceeds the maximum speed because of the spindle speed override function, the spindle speed is clamped at the maximum speed set in the parameter.

NOTE

- 1 This parameter is valid when the multi-spindle control option is selected.
- 2 When the constant surface speed control option is selected, the spindle speed is clamped at the specified maximum speed, regardless of whether the G96 mode or G97 mode is specified.
- 3 When 0 is set in this parameter, the setting of parameter No.3772 for the first spindle is used.
When 0 is set in parameter No.3772, the spindle speed is not clamped.
- 4 When spindle speed command control is applied using the PMC, this parameter has no effect, and the spindle speed is not clamped.

3811

Maximum spindle speed for gear 1 of the second spindle

3812

Maximum spindle speed for gear 2 of the second spindle

[Data type] Word**[Unit of data]** min⁻¹**[Valid data range]** 0 to 32767

Set the maximum spindle speed for each gear of the second spindle.

NOTE

These parameters are used for the multi-spindle control.

3820

Data for adjusting the gain of the analog output of the third-spindle speed

[Data type] Word**[Unit of data]** 0.1%**[Valid data range]** 700 to 1250

Set the data used for adjusting the gain of the analog output of the third spindle speed.

NOTE

This parameter is used for controlling the multi-spindles.

3821

Offset-voltage compensation value of the analog output of the third-spindle speed

[Data type] Word**[Unit of data]** Velo**[Valid data range]** -1024 to 1024

Set the offset-voltage compensation value of the analog output of the third-spindle speed.

NOTE

This parameter is used for controlling the multi-spindles.

3822	Maximum speed of the third spindle
------	------------------------------------

[Data type] Word

[Unit of data] min^{-1}

[Valid data range] 0 to 32767

This parameter sets the maximum speed for the third spindle.

When a command specifying a speed exceeding the maximum spindle speed is specified, or the spindle speed exceeds the maximum speed because of the spindle speed override function, the spindle speed is clamped at the maximum speed set in the parameter.

NOTE

- 1 This parameter is valid when the multi-spindle control option is selected.
- 2 When the constant surface speed control option is selected, the spindle speed is clamped at the specified maximum speed, regardless of whether the G96 mode or G97 mode is set.
- 3 When 0 is set in this parameter, the setting of parameter No.3772 for the first spindle is used. When 0 is set in parameter No.3772, the spindle speed is not clamped.
- 4 When spindle speed command control is applied using the PMC, this parameter has no effect, and the speed of the spindle is not clamped.

3831	Maximum spindle speed for gear 1 of the third spindle
------	---

3832	Maximum spindle speed for gear 2 of the third spindle
------	---

[Data type] Word

[Unit of data] min^{-1}

[Valid data range] 0 to 32767

Set the maximum spindle speed for each gear of the third spindle.

NOTE

These parameters are used for the multi-spindle control.

3850	Upper limit of spindle speed of the fourth spindle
------	--

[Data type] 2-word

[Unit of data] min^{-1}

[Valid data range] 0 to 32767

Set the upper limit of spindle speed of the fourth spindle. This parameter is valid if multi-spindle control is performed.

NOTE

This parameter is valid just for Series 16i.

3851	Maximum spindle speed corresponding to gear 1 of the fourth spindle
3852	Maximum spindle speed corresponding to gear 2 of the fourth spindle

[Data type] 2-word

[Unit of data] min^{-1}

[Valid data range] 0 to 32767

Set the maximum spindle speed corresponding to each gear of the fourth spindle. This parameter is valid if multi-spindle control is performed.

NOTE

This parameter is valid just for Series 16i.

Table 4.23 (a) Parameters for Control of Serial Interface Spindle Cs Contouring Control Axis

No.	Data type	Description	
3900	Byte	First group for the first spindle	Number of the servo axis whose loop gain is to be changed according to the set values of parameters 3901 to 3904 when the Cs contouring axis is controlled (set values 0 to 8)
3901	Word		Loop gain for the servo axis when the Cs contouring axis is controlled for spindle gear 1 selection
3902	Word		Loop gain for the servo axis when the Cs contouring axis is controlled for spindle gear 2 selection
3903	Word		Loop gain for the servo axis when the Cs contouring axis is controlled for spindle gear 3 selection
3904	Word		Loop gain for the servo axis when the Cs contouring axis is controlled for spindle gear 4 selection
3910	Byte	Second group for the first spindle	Number of the servo axis whose loop gain is to be changed according to the set values of parameters 3911 to 3914 when the Cs contouring axis is controlled (set values 0 to 8)
3911	Word		Loop gain for the servo axis when the Cs contouring axis is controlled for spindle gear 1 selection
3912	Word		Loop gain for the servo axis when the Cs contouring axis is controlled for spindle gear 2 selection
3913	Word		Loop gain for the servo axis when the Cs contouring axis is controlled for spindle gear 3 selection
3914	Word		Loop gain for the servo axis when the Cs contouring axis is controlled for spindle gear 4 selection
3920	Byte	Third group for the first spindle	Number of the servo axis whose loop gain is to be changed according to the set values of parameters 3921 to 3924 when the Cs contouring axis is controlled (set values 0 to 8)
3921	Word		Loop gain for the servo axis when the Cs contouring axis is controlled for spindle gear 1 selection
3922	Word		Loop gain for the servo axis when the Cs contouring axis is controlled for spindle gear 2 selection
3923	Word		Loop gain for the servo axis when the Cs contouring axis is controlled for spindle gear 3 selection
3924	Word		Loop gain for the servo axis when the Cs contouring axis is controlled for spindle gear 4 selection

Table 4.23 (a) Parameters for Control of Serial Interface Spindle Cs Contouring Control Axis

No.	Data type	Description	
3930	Byte	Fourth group for the first spindle	Number of the servo axis whose loop gain is to be changed according to the set values of parameters 3931 to 3934 when the Cs contouring axis is controlled (set values 0 to 8)
3931	Word		Loop gain for the servo axis when the Cs contouring axis is controlled for spindle gear 1 selection
3932	Word		Loop gain for the servo axis when the Cs contouring axis is controlled for spindle gear 2 selection
3933	Word		Loop gain for the servo axis when the Cs contouring axis is controlled for spindle gear 3 selection
3934	Word		Loop gain for the servo axis when the Cs contouring axis is controlled for spindle gear 4 selection
3940	Byte	Fifth group for the first spindle	Number of the servo axis whose loop gain is to be changed according to the set values of parameters 3941 to 3944 when the Cs contouring axis is controlled (set values 0 to 8)
3941	Word		Loop gain for the servo axis when the Cs contouring axis is controlled for spindle gear 1 selection
3942	Word		Loop gain for the servo axis when the Cs contouring axis is controlled for spindle gear 2 selection
3943	Word		Loop gain for the servo axis when the Cs contouring axis is controlled for spindle gear 3 selection
3944	Word		Loop gain for the servo axis when the Cs contouring axis is controlled for spindle gear 4 selection

<Setting method>

First, select servo axes which perform interpolation with the Cs contouring axis. (Up to five axes can be selected.)

When there is no servo axis for interpolation with the Cs contouring axis, set the parameters 3900, 3910, 3920, 3930, and 3940 to 0 to terminate parameter setting.

When there are servo axes for interpolation with the Cs contouring axis, the parameters must be set according to the procedure below for each axis.

- (1) Set the number of a servo axis (1 to 8) for interpolation with the Cs contouring axis in parameters 39n0 (n = 0, 1, 2, 3, and 4).
- (2) Set loop gain values of the servo axis specified in (1) above which is used when the Cs contouring axis is controlled in parameters 39n1, 39n2, 39n3, and 39n4. (There are four stages for main gears used.)
- (3) When the number of specified servo axes is less than 5, set the remaining parameters (39n0) to 0 to terminate parameter setting.
When the number of a Cs contouring axis is set to parameter 39n0, the parameter is assumed to be set to 0.

NOTE

The loop gain used for Cs contouring control is selected when the mode changes from the spindle mode to the Cs contouring axis control mode according to the gears set at this time.

If gears are switched in the Cs contouring axis control mode, the loop gain cannot be changed.

Table 4.23 (b) Parameters for serial interface spindle (α series)

No.	Data type	Parameters to be used if the spindle switch function is not used or to be used for the MAIN spindle when the spindle is switched (No.4000 to 4135)
4000	Bit	Bit parameter
4001	Bit	Bit parameter
4002	Bit	Bit parameter
4003	Bit	Bit parameter
4004	Bit	Bit parameter
4005	Bit	Bit parameter
4006	Bit	Bit parameter
4007	Bit	Bit parameter
4008	Bit	Bit parameter
4009	Bit	Bit parameter
4010	Bit	Bit parameter
4011	Bit	Bit parameter
4012	Bit	Bit parameter
4013	Bit	Bit parameter
4014	Bit	Bit parameter
4015	Bit	Bit parameter (Cannot be changed by the user. See Note 1.)
4016	Bit	Bit parameter
4017	Bit	Bit parameter
4018	Bit	Bit parameter
4019	Bit	Bit parameter (For setting parameters automatically. See Note 2.)
4020	Word	Maximum motor speed
4021	Word	Maximum speed under Cs contour control
4022	Word	Speed arrival detection level
4023	Word	Speed detection level
4024	Word	Speed zero detection level
4025	Word	Torque limit value
4026	Word	Load detection level 1
4027	Word	Load detection level 2
4028	Word	Output limit pattern
4029	Word	Output limit value
4030	Word	Soft start/stop time
4031	Word	Position coder method orientation stop position
4032	Word	Acceleration/deceleration time constant when spindle synchronization is controlled
4033	Word	Arrival level for the spindle synchronization speed
4034	Word	Shift amount when the spindle phase synchronization is controlled
4035	Word	Spindle phase synchronization compensation data
4036	Word	Feed forward factor
4037	Word	Velocity loop feed forward factor
4038	Word	Spindle orientation speed
4039	Word	Temperature compensation gain

No.	Data type	Parameters to be used if the spindle switch function is not used or to be used for the MAIN spindle when the spindle is switched (No.4000 to 4135)
4040	Word	Normal velocity loop proportional gain (HIGH)
4041	Word	Normal velocity loop proportional gain (LOW)
4042	Word	Velocity loop proportional gain during orientation (HIGH)
4043	Word	Velocity loop proportional gain during orientation (LOW)
4044	Word	Velocity loop proportional gain in servo mode/spindle synchronization (HIGH)
4045	Word	Velocity loop proportional gain in servo mode/spindle synchronization (LOW)
4046	Word	Velocity loop proportional gain in Cs contour control (HIGH)
4047	Word	Velocity loop proportional gain in Cs contour control (LOW)
4048	Word	Normal velocity loop integral gain (HIGH)
4049	Word	Normal velocity loop integral gain (LOW)
4050	Word	Velocity loop integral gain during orientation (HIGH)
4051	Word	Velocity loop integral gain during orientation (LOW)
4052	Word	Velocity loop integral gain in servo mode/spindle synchronization (HIGH)
4053	Word	Velocity loop integral gain in servo mode/spindle synchronization (LOW)
4054	Word	Velocity loop integral gain in Cs contour control (HIGH)
4055	Word	Velocity loop integral gain in Cs contour control (LOW)
4056	Word	Gear ratio (HIGH)
4057	Word	Gear ratio (MEDIUM HIGH)
4058	Word	Gear ratio (MEDIUM LOW)
4059	Word	Gear ratio (LOW)
4060	Word	Position gain during orientation (HIGH)
4061	Word	Position gain during orientation (MEDIUM HIGH)
4062	Word	Position gain during orientation (MEDIUM LOW)
4063	Word	Position gain during orientation (LOW)
4064	Word	Position gain change ratio when orientation is completed
4065	Word	Position gain in servo mode/spindle synchronization (HIGH)
4066	Word	Position gain in servo mode/spindle synchronization (MEDIUM HIGH)
4067	Word	Position gain in servo mode/spindle synchronization (MEDIUM LOW)
4068	Word	Position gain in servo mode/spindle synchronization (LOW)
4069	Word	Position gain in Cs contour control (HIGH)
4070	Word	Position gain in Cs contour control (MEDIUM HIGH)
4071	Word	Position gain in Cs contour control (MEDIUM LOW)
4072	Word	Position gain in Cs contour control (LOW)
4073	Word	Grid shift amount in servo mode
4074	Word	Reference position return speed in Cs contour/servo mode
4075	Word	Orientation completion signal detection level
4076	Word	Motor velocity limit value during orientation
4077	Word	Orientation stop position shift amount
4078	Word	MS signal constant
4079	Word	MS signal gain adjustment

No.	Data type	Parameters to be used if the spindle switch function is not used or to be used for the MAIN spindle when the spindle is switched (No.4000 to 4135)
4080	Word	Conventional: Regenerative power limit
		HRV: Regenerative power limit in high-speed area/Regenerative power limit
4081	Word	Delay time prior to motor power shut-off
4082	Word	Acceleration/deceleration time setting
4083	Word	Motor voltage during normal rotation
4084	Word	Motor voltage during orientation
4085	Word	Motor voltage in servo mode/spindle synchronization
4086	Word	Motor voltage in Cs contour control
4087	Word	Over-speed level
4088	Word	Excessive velocity deviation detection level when the motor is constrained
4089	Word	Excessive velocity deviation detection level when the motor is rotated
4090	Word	Overload detection level
4091	Word	Position gain change ratio when returning to the origin in the servo mode
4092	Word	Position gain change ratio when returning to the origin in Cs contour control
4093	Word	Load meter displayed value for maximum output (low-speed winding)
4094	Word	Disturbance torque compensation constant
4095	Word	Speed meter output voltage adjustment value
4096	Word	Load meter output voltage adjustment value
4097	Word	Spindle velocity feedback gain
4098	Word	Maximum speed at which position coder signal can be detected
4099	Word	Delay time for energizing the motor
4100	Word	Conventional:Base velocity of the motor output specification
		HRV:Base velocity of the motor output specification
4101	Word	Conventional:Output limit value for the motor output specification
		HRV:Torque limit value for the motor output specification
4102	Word	Conventional:Base speed
		HRV:Excitation voltage saturation speed under no load
4103	Word	Conventional:Magnetic flux weakening start velocity
		HRV:Base speed limit ratio
4104	Word	Conventional:Current loop proportional gain
		HRV:Current loop proportional gain
4105	Word	Conventional:Current loop proportional gain (in Cs contour control)
		HRV:Reserved
4106	Word	Conventional:Current loop integral gain
		HRV:Current loop integral gain
4107	Word	Conventional:Current loop integral gain (in Cs contour control)
		HRV:Reserved
4108	Word	Conventional:Current loop integral gain zero speed
		HRV:Current loop integral gain zero speed
4109	Word	Conventional:Current loop proportional gain velocity factor
		HRV:Filter time constant when the specified voltage is saturated

No.	Data type	Parameters to be used if the spindle switch function is not used or to be used for the MAIN spindle when the spindle is switched (No.4000 to 4135)
4110	Word	Conventional:Current conversion constant
		HRV:Current conversion constant
4111	Word	Conventional:Secondary current factor for exciting current
		HRV:Secondary current factor
4112	Word	Conventional:Current expectation constant
		HRV:Level for determining the saturation of specified voltage/PWM command clamp value
4113	Word	Conventional:Slip constant
		HRV:Slip constant
4114	Word	Conventional:High-speed rotation slip compensation constant
		HRV:Slip compensation factor in high-speed area/Slip compensation factor during deceleration
4115	Word	Conventional:Compensation constant of voltage applied to motor in the dead zone
		HRV:PWM command clamp value during deceleration
4116	Word	Conventional:Electromotive force compensation constant
		HRV:Motor leak constant
4117	Word	Conventional:Electromotive force phase compensation constant
		HRV:Voltage compensation factor in high-speed area in steady state/Motor voltage factor in steady state
4118	Word	Conventional:Electromotive force compensation velocity factor
		HRV:Voltage compensation factor in high-speed area during acceleration/Motor voltage factor during acceleration
4119	Word	Conventional:Time constant of voltage filter for electromotive force compensation
		HRV:Time constant for changing the exciting current during deceleration
4120	Word	Conventional:Dead zone compensation data
		HRV:Voltage without rectangular wave component/Dead zone compensation data
4121	Word	Time constant for changing the torque
4122	Word	Velocity detection filter time constant
4123	Word	Short-term overload detection time
4124	Word	Conventional:Voltage compensation factor during deceleration
		HRV:Reserved
4125	Word	
4126	Word	
4127	Word	Conventional:Load meter displayed value for maximum output
		HRV:Load meter displayed value for maximum output
4128	Word	Conventional:Maximum output limit zero speed
		HRV:Maximum torque curve compensation factor
4129	Word	Conventional:Secondary current factor during rigid tapping
		HRV:Secondary current factor during rigid tapping
4130	Word	Conventional:Compensation factor for the phase of the electromotive force during deceleration
		HRV:Velocity factor for the proportional gain of the current loop/Current phase lag compensation constant

No.	Data type	Parameters to be used if the spindle switch function is not used or to be used for the MAIN spindle when the spindle is switched (No.4000 to 4135)
4131	Word	Time constant of the speed detection filter (in Cs contour control)
4132	Word	Conversion constant of the phase-V current
4133	Word	Motor model code
4134	2Word	
4135	2Word	Grid shift amount in Cs contour control

No.	Data type	Parameters for low-speed characteristics if the spindle switch function is not used or if the output switch function is used on the MAIN spindle when the spindle is switched (No.4136 to 4175)
4136	Word	Motor voltage during normal rotation
4137	Word	Motor voltage in servo mode/spindle synchronization
4138	Word	Conventional:Base velocity of the motor output specification
		HRV:Base velocity of the motor output specification
4139	Word	Conventional:Output limit value for the motor output specification
		HRV:Torque limit value for the motor output specification
4140	Word	Conventional:Base speed
		HRV:Excitation voltage saturation speed under no load
4141	Word	Conventional:Magnetic flux weakening start velocity
		HRV:Base speed limit ratio
4142	Word	Conventional:Current loop proportional gain
		HRV:Current loop proportional gain
4143	Word	Conventional:Current loop integral gain
		HRV:Current loop integral gain
4144	Word	Conventional:Current loop integral gain zero speed
		HRV:Current loop integral gain zero speed
4145	Word	Conventional:Current loop proportional gain velocity factor
		HRV:Filter time constant when the specified voltage is saturated
4146	Word	Conventional:Current conversion constant
		HRV:Current conversion constant
4147	Word	Conventional:Secondary current factor for exciting current
		HRV:Secondary current factor
4148	Word	Conventional:Current expectation constant
		HRV:Level for determining the saturation of specified voltage/PWM command clamp value
4149	Word	Conventional:Slip constant
		HRV:Slip constant
4150	Word	Conventional:High-speed rotation slip compensation constant
		HRV:Slip compensation factor in high-speed area/Slip compensation factor during deceleration
4151	Word	Conventional:Compensation constant of voltage applied to motor in the dead zone
		HRV:PWM command clamp value during deceleration

No.	Data type	Parameters for low-speed characteristics if the spindle switch function is not used or if the output switch function is used on the MAIN spindle when the spindle is switched (No.4136 to 4175)
4152	Word	Conventional:Electromotive force compensation constant
		HRV:Motor leak constant
4153	Word	Conventional:Electromotive force phase compensation constant
		HRV:Voltage compensation factor in high-speed area in steady state/Motor voltage factor in steady state
4154	Word	Conventional:Electromotive force compensation velocity factor
		HRV:Voltage compensation factor in high-speed area during acceleration/Motor voltage factor during acceleration
4155	Word	Conventional:Voltage compensation factor during deceleration
		HRV:Reserved
4156	Word	Temperature compensation gain
4157	Word	Time constant for changing the torque
4158	Word	Conventional:Maximum output limit zero speed
		HRV:Maximum torque curve compensation factor
4159	Word	Conventional:Secondary current factor during rigid tapping
		HRV:Secondary current factor during rigid tapping
4160	Word	Hysteresis of the speed detection level
4161	Word	Conventional:Compensation factor for the phase of the electromotive force during deceleration
		HRV:Velocity factor for the proportional gain of the current loop/Current phase lag compensation constant
4162	Word	Cutting feed velocity loop integral gain in Cs contour control (HIGH)
4163	Word	Cutting feed velocity loop integral gain in Cs contour control (LOW)
4164	Word	Conversion constant of the phase-V current
4165	Word	Conventional:Time constant of voltage filter for electromotive force compensation
		HRV:Time constant for changing the exciting current during deceleration/Time constant for changing the exciting current
4166	Word	Conventional:Regenerative power limit
		HRV:Regenerative power limit in high-speed area/Regenerative power limit
4167	Word	
4168	Word	Overload current alarm detection level (for low-speed characteristics)
4169	Word	Overload current alarm detection time constant
4170	Word	Overload current alarm detection level (for high speed characteristics)
4171	Word	Number of teeth of spindle gear (HIGH)
4172	Word	Number of teeth of position detector gear (HIGH)
4173	Word	Number of teeth of spindle gear (LOW)
4174	Word	Number of teeth of position detector gear (LOW)
4175	Word	Analog override zero level

No.	Data type	Parameters for SUB spindle if the spindle switch function is provided (No.4176 to 4283)
4176	Bit	Bit parameter
4177	Bit	Bit parameter
4178	Bit	Bit parameter
4179	Bit	Bit parameter
4180	Bit	Bit parameter
4181	Bit	Bit parameter
4182	Bit	Bit parameter
4183	Bit	Bit parameter
4184	Bit	Bit parameter
4185	Bit	Bit parameter
4186	Bit	Bit parameter
4187	Bit	Bit parameter
4188	Bit	Bit parameter
4189	Bit	Bit parameter
4190	Bit	Bit parameter
4191	Bit	Bit parameter (Cannot be changed by the user. See Note 1.)
4192	Bit	Bit parameter
4193	Bit	Bit parameter
4194	Bit	Bit parameter
4195	Bit	Bit parameter (For setting parameters automatically. See Note 2.)
4196	Word	Maximum motor speed
4197	Word	Speed arrival detection level
4198	Word	Speed detection level
4199	Word	Speed zero detection level
4200	Word	Torque limit value
4201	Word	Load detection level 1
4202	Word	Output limit pattern
4203	Word	Output limit value
4204	Word	Position coder method orientation stop position
4205	Word	Spindle orientation speed
4206	Word	Normal velocity loop proportional gain (HIGH)
4207	Word	Normal velocity loop proportional gain (LOW)
4208	Word	Velocity loop proportional gain during orientation (HIGH)
4209	Word	Velocity loop proportional gain during orientation (LOW)
4210	Word	Velocity loop proportional gain in servo mode (HIGH)
4211	Word	Velocity loop proportional gain in servo mode (LOW)
4212	Word	Normal velocity loop integral gain
4213	Word	Velocity loop integral gain during orientation
4214	Word	Velocity loop integral gain in servo mode
4215	Word	
4216	Word	Gear ratio (HIGH)
4217	Word	Gear ratio (LOW)

No.	Data type	Parameters for SUB spindle if the spindle switch function is provided (No.4176 to 4283)
4218	Word	Position gain during orientation (HIGH)
4219	Word	Position gain during orientation (LOW)
4220	Word	Position gain change ratio when orientation is completed
4221	Word	Position gain in servo mode (HIGH)
4222	Word	Position gain in servo mode (LOW)
4223	Word	Grid shift amount in servo mode
4224	Word	
4225	Word	
4226	Word	Orientation completion signal level
4227	Word	Motor velocity limit value during orientation
4228	Word	Orientation stop position shift amount
4229	Word	MS signal constant
4230	Word	MS signal gain adjustment
4231	Word	Regenerative power limit
4232	Word	Delay time prior to motor power shut-off
4233	Word	Acceleration/deceleration time setting
4234	Word	Spindle load monitor observer gain 1 (on the SUB side)
4235	Word	Spindle load monitor observer gain 2 (on the SUB side)
4236	Word	Motor voltage during normal rotation
4237	Word	Motor voltage during orientation
4238	Word	Motor voltage in servo mode
4239	Word	Position gain change ratio when returning to the origin in the servo mode
4240	Word	Feed forward coefficient
4241	Word	Velocity loop feed forward factor
4242	Word	
4243	Word	Number of teeth of spindle gear (HIGH)
4244	Word	Number of teeth of position detector gear (HIGH)
4245	Word	Number of teeth of spindle gear (LOW)
4246	Word	Number of teeth of position detector gear (LOW)
4247	Word	Spindle load monitor magnetic flux compensation time constant (for high-speed characteristics on the MAIN side)
4248	Word	Spindle load monitor torque constant (for high-speed characteristics on the MAIN side)
4249	Word	Spindle load monitor observer gain 1 (on the MAIN side)
4250	Word	Spindle load monitor observer gain 2 (on the MAIN side)
4251	Word	Spindle load monitor magnetic flux compensation time constant (for low-speed characteristics on the MAIN side)
4252	Word	Spindle load monitor magnetic flux compensation time constant (for high-speed characteristics on the SUB side)
4253	Word	Spindle load monitor magnetic flux compensation time constant (for low-speed characteristics on the SUB side)
4254	Word	Temperature compensation gain (for high-speed characteristics on the SUB side)
4255	Word	Temperature compensation gain (for low-speed characteristics on the SUB side)
4256	Word	Base velocity of the motor output specification

No.	Data type	Parameters for SUB spindle if the spindle switch function is provided (No.4176 to 4283)
4257	Word	Output limit value for the motor output specification
4258	Word	Base speed
4259	Word	Magnetic flux weakening start velocity
4260	Word	Current loop proportional gain
4261	Word	Current loop integral gain
4262	Word	Current loop integral gain zero speed
4263	Word	Current loop proportional gain velocity factor
4264	Word	Current conversion constant
4265	Word	Secondary current factor for exciting current
4266	Word	Current expectation constant
4267	Word	Slip constant
4268	Word	High-speed rotation slip compensation constant
4269	Word	Compensation constant of voltage applied to motor in the dead zone
4270	Word	Electromotive force compensation constant
4271	Word	Electromotive force phase compensation constant
4272	Word	Electromotive force compensation velocity factor
4273	Word	Time constant for changing the torque
4274	Word	Load meter displayed value for maximum output
4275	Word	Maximum output limit zero speed
4276	Word	Secondary current factor during rigid tapping
4277	Word	Compensation factor for the phase of the electromotive force during deceleration
4278	Word	Velocity detection filter time constant
4279	Word	Load meter displayed value at maximum output (low-speed winding)
4280	Word	Time constant of voltage filter for electromotive force compensation
4281	Word	Spindle load monitor torque constant (for low-speed characteristics on the MAIN side)
4282	Word	Spindle load monitor torque constant (for high-speed characteristics on the SUB side)
4283	Word	Spindle load monitor torque constant (for low-speed characteristics on the SUB side)

No.	Data type	Parameters for low-speed characteristics when the output switch function is used on the SUB spindle side if the spindle switch function is provided (No.4284 to 4351)
4284	Word	Motor voltage during normal rotation
4285	Word	Motor voltage in servo mode
4286	Word	Base velocity of the motor output specification
4287	Word	Output limit value for the motor output specification
4288	Word	Base speed
4289	Word	Magnetic flux weakening start velocity
4290	Word	Current loop proportional gain
4291	Word	Current loop integral gain
4292	Word	Current loop integral gain zero speed
4293	Word	Current loop proportional gain velocity factor
4294	Word	Current conversion constant
4295	Word	Secondary current factor for exciting current
4296	Word	Current expectation constant
4297	Word	Slip constant
4298	Word	High-speed rotation slip compensation constant
4299	Word	Compensation constant of voltage applied to motor in the dead zone
4300	Word	Electromotive force compensation constant
4301	Word	Electromotive force phase compensation constant
4302	Word	Electromotive force compensation velocity factor
4303	Word	Time constant for changing the torque
4304	Word	Maximum output limit zero speed
4305	Word	Secondary current factor during rigid tapping
4306	Word	Compensation factor for the phase of the electromotive force during deceleration
4307	Word	Regenerative power limit
4308	Word	Time constant of voltage filter for electromotive force compensation
4309	Word	Motor model code
4310	2Word	
4311	2Word	
4312	Word	Position coder method orientation end signal detection level 2 (MAIN)
4313	Word	Magnetic sensor method orientation end signal detection level 1 (MAIN)
4314	Word	Magnetic sensor method orientation end signal detection level 2 (MAIN)
4315	Word	Magnetic sensor method orientation stop position shift amount (MAIN)
4316	Word	Position coder method orientation end signal detection level 2 (SUB)
4317	Word	Magnetic sensor method orientation end signal detection level 1 (SUB)
4318	Word	Magnetic sensor method orientation end signal detection level 2 (SUB)
4319	Word	Magnetic sensor method orientation stop position shift amount (SUB)
4320	Word	Motor deceleration time constant (MAIN/HIGH)
4321	Word	Motor deceleration time constant (MAIN/MEDIUM HIGH)
4322	Word	Motor deceleration time constant (MAIN/MEDIUM LOW)
4323	Word	Motor deceleration time constant (MAIN/LOW)
4324	Word	Motor deceleration time constant (SUB/HIGH)

No.	Data type	Parameters for low-speed characteristics when the output switch function is used on the SUB spindle side if the spindle switch function is provided (No.4284 to 4351)
4325	Word	Motor deceleration time constant (SUB/LOW)
4326	Word	Deceleration time constant limit start speed (MAIN/HIGH)
4327	Word	Deceleration time constant limit start speed (SUB/HIGH)
4328	Word	Position coder-based spindle orientation command multiplication (MAIN)
4329	Word	Position coder-based spindle orientation command multiplication (SUB)
4330	Word	Deceleration time constant limit start speed (MAIN/LOW)
4331	Word	Deceleration time constant limit start speed (SUB/LOW)
4332	Word	
4333	Word	
4334	Word	Number of arbitrary pulses of speed detector (MAIN)
4335	Word	Number of arbitrary pulses of speed detector (SUB)
4336	Word	Change point for spindle synchronous acceleration/deceleration time constant
4337	Word	Velocity compensation factor for velocity loop gain (MAIN)
4338	Word	Velocity compensation factor for velocity loop gain (SUB)
4339	Word	Torque clamp level
4340	Word	Bell-shaped acceleration/deceleration time constant for spindle synchronization
4341	Word	Abnormal load detection level
4342	Word	
4343	Word	
4344	Word	Look-ahead feed forward coefficient
4345	Word	Spindle motor speed command detection level
4346	Word	Incomplete integral coefficient
4347	Word	Detection level for spindle 1-to-2 speed difference at slave operation
4348	Word	Overload current alarm detection level (for low-speed characteristics)
4349	Word	Overload current alarm detection time constant
4350	Word	Overload current alarm detection level (for high-speed characteristics)
4351	Word	Compensation for current detection offset

No.	Data type	Parameters for the MAIN spindle when the spindle is switched and the like (No.4352 to 4372)
4352	Bit	Bit parameter
4353	Bit	Bit parameter
4354	Word	
4355	Word	MZ sensor signal amplitude ratio compensation
4356	Word	MZ sensor signal phase difference compensation
4357	Word	BZ sensor signal amplitude ratio compensation
4358	Word	BZ sensor signal phase difference compensation
4359	Word	
4360	Word	
4361	Word	Number of arbitrary pulses of position detector
4362	Word	

No.	Data type	Parameters for the MAIN spindle when the spindle is switched and the like (No.4352 to 4372)
4363	Word	
4364	Word	
4365	Word	
4366	Word	
4367	Word	
4368	Word	
4369	Word	
4370	Word	
4371	Word	
4372	Word	Safe rotation speed

No.	Data type	Parameters for the SUB spindle when the spindle is switched and the like (No.4373 to 4393)
4373	Bit	Bit parameter
4374	Bit	Bit parameter
4375	Word	Shift amount in synchronous control of the spindle phase
4376	Word	
4377	Word	
4378	Word	
4379	Word	
4380	Word	
4381	Word	
4382	Word	
4383	Word	
4384	Word	EGB automatic phasing maximum speed
4385	Word	EGB automatic phasing acceleration/deceleration time constant
4386	Word	Number of sinusoidal waves of position detector of the master spindle
4387	Word	Numerator of EGB synchronization ratio
4388	Word	Denominator of EGB synchronization ratio
4389	Word	
4390	Word	
4391	Word	Center frequency of vibration suppression filter
4392	Word	Frequency width of vibration suppression filter
4393	Word	

Notes on parameters of the spindle amplifier with the serial interface

NOTE

- 1 Among the parameters of the spindle amplifier with the serial interface, parameters Nos. 4015 and 4191 cannot be changed by the users.

These parameters require to assign optional software to the CNC and are automatically set depending on the type of the software.

- 2 To set the parameters of the spindle amplifier with the serial interface automatically, set #7 of parameter No.4019 (if the sub spindle is set in the CNC with the spindle switching function, use parameter No.4195) to 1, assign the model code of the motor to be used to parameter No.4133 (if the sub spindle is set in the CNC with the spindle switching function, use parameter No.4309), turn off the power of the CNC and spindle amplifier, and restart the CNC and spindle amplifier.

- 3 Parameters No.4000 to No.4539 are used in the processing on the spindle amplifier. See FANUC AC SPINDLE MOTOR α series PARAMETER MANUAL (B-65150E).

- 4 The CNC can control up to four spindle amplifiers (three spindle amplifiers for Series 18*i*) with the serial interface.

Up to three spindle amplifiers can be controlled in the Series 16 performing single-path control.

When the spindle control amplifier provides the spindle switching function, one spindle amplifier can control two spindle motors using the switching function.

The output switching function can be used in spindle motors to be connected.

Up to eight spindles, or sixteen types, can be used by switching the spindle motors. (The number of spindles that can controlled simultaneously is the same as the number of spindle amplifiers, that is four spindles.)

Parameters of the spindle amplifier with the serial interface correspond to the above functions as follows:

- (1) Parameter No.4000 to No.4539 "S1": First spindle amplifier

Parameter No.4000 to No.4539 "S2": Second spindle amplifier

Parameter No.4000 to No.4539 "S3": Third spindle amplifier

Parameter No.4000 to No.4539 "S4" (only for Series 16*i*): Fourth spindle amplifier

- (2) Parameter No.4000 to No.4175 "S1"/"S2"/"S3"/"S4": When the spindle switching function is not provided, or for the main spindle in the spindle amplifier when the function is provided.
Parameter No.4176 to No.4351 "S1"/"S2"/"S3"/"S4": For the sub spindle in the spindle amplifier when the spindle switching function is provided.

- (3) Parameters at low speed when the output switching function is provided.

Parameters No.4136 to No.4175 "S1"/"S2"/"S3"/"S4": When the spindle switching function is not provided, or for the main spindle when the function is provided.

Parameters No.4284 to No.4351 "S1"/"S2"/"S3"/"S4": For the sub spindle when the spindle switching function is provided.

- 5 The CNC stores the parameters of the spindle amplifier with the serial interface. The CNC sends them to the spindle amplifier at the system power on and they are used in the unit.

These parameters are sent from the CNC to the spindle amplifier in a batch when:

- The CNC is switched on.
- The serial spindle is restarted by a reset that is carried out after spindle communication alarm 749 occurs (because the spindle control unit is switched off or because of noise).

If these parameters are rewritten, they are sent from the CNC to the spindle amplifier sequentially when:

- The parameters have been entered from the MDI.
- The parameters have been entered as programmable (G10).
- The parameters have been entered via the reader/punch interface.

To set parameters automatically, upload parameters corresponding to the motor model from the spindle amplifier to the CNC prior to the procedure specified above.

The parameters of the spindle amplifier with serial interface can be changed after the system starts. Changing the parameters (No.4000 to No.4539 "S1", "S2", "S3", "S4") in the CNC sends them to the spindle amplifier at an appropriate time and the parameters in the unit are updated. Be careful not to change parameters incorrectly.

- 6 The fourth spindle amplifier can be used just in Series 16*i*.

4345	Serial spinsle motor detection speed
------	--------------------------------------

[Data type] Word

[Unit of data] min⁻¹

[Valid data range] 0 to 32767

S1 : for First spindle / S2 : for Second spindle / S3 : for Third spindle

This parameter sets the serial spindle motor speed at which the motor speed detection signal is output. The speeds of the serial spindle motors for the first, second, and third spindles are monitored, and the motor speed detection signal, indicating whether the speed of each spindle exceeds the value set in this parameter, is output to the Y address specified with parameter No.1891.

NOTE

- 1 The motor speed detection signals are not output when the servo/spindle motor speed detection function is not used, or 0 is set for this parameter.
- 2 For this parameter, set a motor speed rather than a spindle speed.

	#7	#6	#5	#4	#3	#2	#1	#0
4800	SPK	EPZ			ND4	ND3	ND2	ND1

NOTE

When this parameter is set, the power must be turned off before operation is continued.

[Data type] Bit

- ND1** In controlling the spindle synchronization, the direction of the first spindle motor rotation is:
 0 : The direction indicated by the command sign
 1 : The opposite direction to that indicated by the command sign
- ND2** In controlling the spindle synchronization, the direction of the 2nd spindle motor rotation is:
 0 : The direction indicated by the command sign
 1 : The opposite direction to that indicated by the command sign
- ND3** Under synchronous spindle control, the direction of rotation of the third spindle motor is:
 0 : The same as the specified sign.
 1 : The opposite of the specified sign. This parameter is usable only when parameter SSS (bit 4 of parameter No. 3704) = 1.
- ND4** Under synchronous spindle control, the direction of rotation of the fourth spindle motor is:
 0 : The same as the specified sign.
 1 : The opposite of the specified sign. This parameter is usable only when parameter SSS (bit 4 of parameter No. 3704) = 1.

NOTE

This parameter is valid just for Series 16*i*.

EPZ If an axis of Cs contour control is used under simple synchronous spindle control, positioning to an axis of Cs contour control immediately after the parking signal is switched is performed by:

0 : Usual positioning operation.

1 : Positioning operation including reference position return.

SPK As the parking signals for simple spindle synchronous control:

0 : PKESS1 <G122#6> (first spindle) and PKESS2 <G122#7> (second spindle) are used.

1 : PKESS1 <G031#6> (first spindle) and PKESS2 <G031#7> (second spindle) are used.

4810

Error pulse between two spindles when synchronizing phases in the serial spindle synchronization control mode

[Data type] Byte

[Unit of data] Pulse

[Valid data range] 0 to 255

Set the difference in error pulses between two spindles when synchronizing phases in the serial spindle synchronization control mode.

When the difference in error pulse between two spindles is within the value set in this parameter, the spindle phase synchronization completion signal FSPPH <F044#3> becomes "1".

This parameter is used to check the difference in phase in synchronization control and to confirm the completion of synchronization in the serial spindle synchronization control mode.

4811

Allowable error count for the error pulses between two spindles in the serial spindle synchronization control mode or simple synchronous control mode

[Data type] Word

[Unit of data] Pulse

[Valid data range] 0 to 32767

Set the allowable error count for the error pulses between two spindles in the serial spindle synchronization control mode or simple synchronous control mode.

NOTE

This parameter is used to output the inter-spindle phase error detection signal SYCAL in the serial spindle synchronization control mode. The SYCAL <F044#4> signal becomes "1" when a phase error exceeding the value set in this parameter is found.

When you are going to use this parameter to detect error pulses during simplified synchronization control, pay attention to the mode of the spindle, and set the parameter as required. (The parameter is invalid in spindle mode. It is valid in Cs contour control, rigid tapping, and spindle positioning mode; the detection unit per pulse differs, however.)

4821

Master axis of first spindle under simple synchronous spindle control

4822

Master axis of second spindle under simple synchronous spindle control

4823

Master axis of third spindle under simple synchronous spindle control

4824

Master axis of fourth spindle under simple synchronous spindle control

NOTE

When this parameter has been set, the power must be turned off before operation is continued.

[Data type] Byte

[Valid data range] 1 to Number of spindles

Set the slave axis and master axis for simple synchronous spindle control by spindles. Set the axis number of the master axis for the axis to be used as the slave axis.

NOTE

- 1 This parameter is valid if bit 5 (SSY) of parameter No. 3704 is set to 1.
- 2 The axis number of the master axis must be smaller than the axis number of the slave axis. Multiple slave axes cannot be specified for the master axis.
- 3 After this parameter is set, the power must be turned off then back on for the setting to become effective.
- 4 Parameter No. 4824 is valid just for Series 16*i*.

4826	Permissible synchronization error under simple synchronous spindle control in which the first spindle is the slave axis
4827	Permissible synchronization error under simple synchronous spindle control in which the second spindle is the slave axis
4828	Permissible synchronization error under simple synchronous spindle control in which the third spindle is the slave axis
4829	Permissible synchronization error under simple synchronous spindle control in which the fourth spindle is the slave axis

[Data type] Word

[Unit of data] Pulse

[Valid data range] 0 to 32767

Set a permissible error of error pulse between two spindles in the mode of simple synchronous spindle control. The data unit is the unit of the detector used meanwhile.

NOTE

- 1 This parameter is valid if bit 5 (SSY) of parameter No. 3704 is set to 1.
- 2 This parameter is used to output the signals of synchronous error detection under synchronous spindle control SYCAL1 to SYCAL4 <F043 bits 0 to 3>.
- 3 Under simple synchronous spindle control in the spindle mode, no synchronization error is detected.
- 4 Parameter No. 4829 is valid just for Series 16*i*.

4831	Master axis of first spindle under synchronous spindle control
4832	Master axis of second spindle under synchronous spindle control
4833	Master axis of third spindle under synchronous spindle control
4834	Master axis of fourth spindle under synchronous spindle control

NOTE

When this parameter has been set, the power must be turned off before operation is continued.

[Data type] Byte

[Valid data range] 1 to Number of spindles

Set the slave axis and master axis of synchronous spindle control by spindles. Set the axis number of the master axis for the axis to be handled as the slave axis.

NOTE

- 1 This parameter is valid if bit 4 (SSS) of parameter No. 3704 is set to 1.
- 2 Multiple slave axes cannot simultaneously enter the synchronization mode for a single master axis.
- 3 After this parameter is set, the power must be turned off then back on for the setting to become effective.
- 4 Parameter No. 4834 is valid only for Series 16i.

	#7	#6	#5	#4	#3	#2	#1	#0
4900								FLR

[Data type] Bit

FLR When the spindle speed fluctuation detection function is used, the rates of allowance (q) and fluctuation (r) those are set in parameter No.4911 and No.4912, respectively are set in steps of:

- 0 : 1%
- 1 : 0.1%

4911	Rapid (q) of the fluctuation of spindle speed which is assumed to be the specified spindle speed
------	--

[Data type] Word

[Unit of data]	Unit of data	1%	0.1% (T series)
[Valid data range]	Data range	1 to 100	1 to 1000

NOTE

Unit of data depends on parameter No.4900#0 FLR (T series only)

Set the ratio (q) of the spindle speed which is assumed to be the specified spindle speed in the spindle speed fluctuation detection function.

Let the commanded speed be S_c . When the actual spindle speed reaches between $(S_c - S_q)$ and $(S_c + S_q)$, it is assumed to be the commanded speed. The spindle speed fluctuation detection starts.

where, $S_q = S_c \times \frac{q}{100}$

4912	Spindle speed fluctuation ratio (r) for which no alarm is activated in the spindle speed fluctuation detection function
------	---

[Data type] Word

[Unit of data]	Unit of data	1%	0.1% (T series)
-----------------------	---------------------	----	-----------------

[Valid data range]	Data range	1 to 100	1 to 1000
---------------------------	-------------------	----------	-----------

NOTE
Unit of data depends on parameter No.4900#0 FLR (T series only).

Set the spindle speed fluctuation ratio (r) for which no alarm is activated in the spindle speed fluctuation detection function (see Fig.4.23 (e)).

4913	Spindle speed fluctuation value (d) for which no alarm is activated in the spindle speed fluctuation detection function
------	---

[Data type] Word

[Unit of data] min⁻¹

[Valid data range] 0 to 32767

Set the allowable fluctuation speed (Sd) for which no alarm is activated in the spindle speed fluctuation detection function.

The function for detecting spindle speed fluctuation checks whether the actual speed varies for the specified speed or not. Sd or Sr, whichever is greater, is taken as the allowable fluctuation speed (Sm). An alarm is activated when the actual spindle speed varies for the commanded speed (Sc) under the condition that the variation width exceeds the allowable variation width (Sm).

Sd: The allowable constant variation width which is independent of the specified spindle speed (Sd is set with parameter 4913.)

Sr: The allowable variation width which is obtained by multiplying Sc (commanded spindle speed) by r (constant ratio). (r is set with parameter 4912.)

Sm: Sd or Sr, whichever is greater

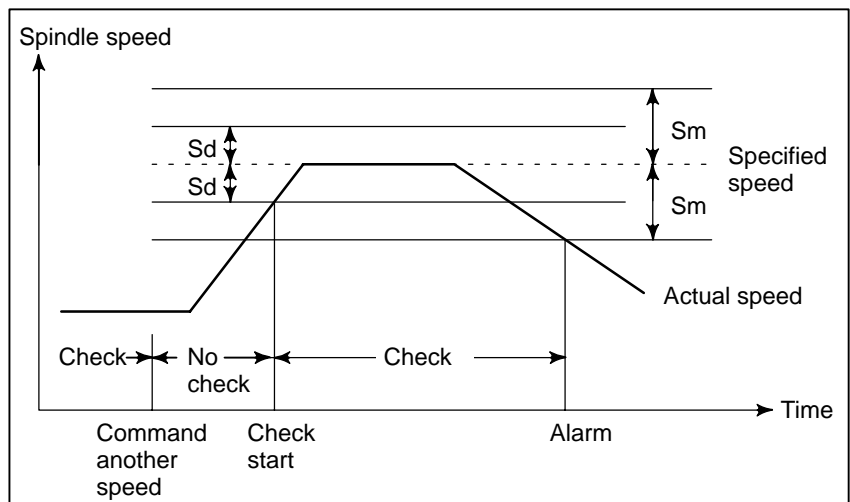

Fig.4.23 (e) Sd and Sm

4914	Time (p) elapsed from when the commanded spindle speed is changed to the start of spindle speed fluctuation detection
------	---

[Data type] 2-word

[Unit of data] ms

[Valid data range] 0 to 999999

Set the time elapsed from when the specified spindle speed is changed to the start of spindle speed fluctuation detection in the spindle speed fluctuation detection function. That is, the fluctuation in the spindle speed is not detected until the specified time elapses from when the specified spindle speed is changed.

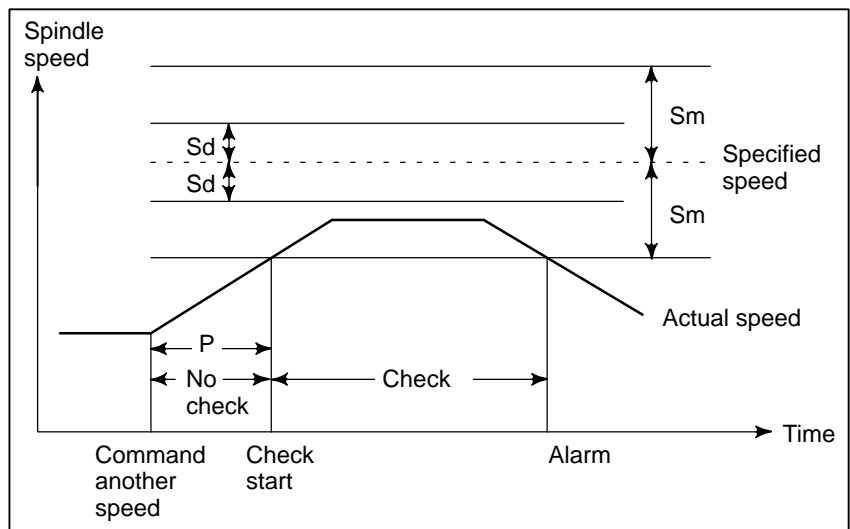

Fig.4.23 (f) Sd and Sm

	#7	#6	#5	#4	#3	#2	#1	#0
4950	IMB	ESI	TRV			ISZ	IDM	IOR

[Data type] Bit

IOR Resetting the system in the spindle positioning mode

0 : Does not releases the mode.

1 : Releases the mode

IDM The positioning direction for the spindle using a M code is

0 : The positive direction

1 : The negative direction

ISZ When an M code for spindle orientation is specified in spindle positioning:

0 : The spindle rotation mode is cleared and the mode is switched to the spindle positioning mode, and spindle orientation operation is performed.

1 : The spindle rotation mode is cleared and the mode is switched to the spindle positioning mode but spindle orientation operation is not performed.

TRV Rotation direction of spindle positioning is set to:

- 0 : The positive direction
- 1 : The reverse direction

ESI Selection of a spindle positioning specification

- 0 : The conventional specification is used.
- 1 : The extended specification is used.

NOTE

The extended specification includes the following two extensions:

- (1) With the conventional specification, the number of M codes for specifying a spindle positioning angle is always 6. With the extended specification, an arbitrary number of such M codes from 1 to 256 can be selected by parameter setting (See parameter No.4964.)
- (2) The maximum feedrate for spindle positioning (setting of parameter No.1420) can be extended from 240000 to 269000 (in increments of 10 deg/min).

IMB When the spindle positioning function is used, half-fixed angle positioning based on M codes uses:

- 0 : Specification A
- 1 : Specification B

NOTE

In the case of half-fixed angle positioning based on M codes, three types of spindle positioning operations can occur:

- (1) The spindle rotation mode is cleared, then the mode is switched to the spindle positioning mode.
- (2) Spindle positioning is performed in the spindle positioning mode.
- (3) The spindle positioning mode is cleared, then the mode is switched to the spindle rotation mode.

In the case of specification A:

Operations (1) to (3) are specified using separate M codes.

- (1) Specified using M codes for performing spindle orientation.
(See parameter No.4960)
- (2) Specified using M codes for specifying a spindle positioning angle. (See parameter No.4962)
- (3) Specified using M codes for clearing spindle positioning operation. (See parameter No.4961.)

In the case of specification B:

When M codes for specifying a spindle positioning angle are specified, operations (1) to (3) are performed successively. (See parameter No.4962.)

4960	M code specifying the spindle orientation

[Data type] Word

[Unit of data] Integer

[Valid data range] 6 to 97

Set an M code to change the spindle rotating mode to the spindle positioning mode. Setting the M code performs the spindle orientation. Spindle positioning can be specified from the next block.

4961	M code releasing the spindle positioning mode

[Data type] Word

[Unit of data] Integer

[Valid data range] 6 to 97

Set the M code to release the spindle positioning mode and to change the mode to the spindle rotating mode.

4962	M code for specifying a spindle positioning angle

[Data type] Word

[Unit of data] Integer

[Valid data range] 6 to 92

Two methods are available for specifying spindle positioning. One method uses address C for arbitrary-angle positioning. The other use an M code for half-fixed angle positioning. This parameter sets an M code for the latter method.

- When bit 6 (ESI) of parameter No.4950=0
Six M code from M_{α} to $M_{(\alpha+5)}$ are used for half-fixed angle positioning, when α is the value of this parameter.
- When bit 6(ESI) of parameter No.4950=1
Set the start M code in this parameter, and set the number of M codes in parameter No.4964. Then β M codes from M_{α} to $M_{(\alpha+\beta-1)}$ are used for half fixed angle positioning.

The table below indicates the relationship between the M codes and positioning angles.

M code	Positioning angle	Example: Positioning angle when $\theta = 30^{\circ}$
M_{α}	θ	30°
$M_{(\alpha+1)}$	2θ	60°
$M_{(\alpha+2)}$	3θ	90°
$M_{(\alpha+3)}$	4θ	120°
$M_{(\alpha+4)}$	5θ	150°
$M_{(\alpha+5)}$	6θ	180°
\vdots	\vdots	\vdots
$M_{(\alpha+n)}$	$(n+1)\theta$	

NOTE

θ represents the basic angular displacement set in parameter No.4963.

4963

Basic angular displacement used for spindle positioning using M code

[Data type] Word**[Unit of data]** deg**[Valid data range]** 1 to 60

This parameter sets a basic angular displacement used for half-fixed angle positioning using M codes.

4964

Number of M codes for specifying a spindle positioning angle

[Data type] Byte**[Unit of data]** Integer**[Valid data range]** 0, 1 to 255

This parameter sets the number of M codes used for Half-fixed angle positioning using M codes.

As many M codes as the number specified in this parameter, starting with the M code specified in parameter No.4962, are used to specify half-fixed angle positioning.

Let α be the value of parameter No.4962, and let β be the value of parameter No.4964. That is, M codes from $M\alpha$ to $M(\alpha+\beta-1)$ are used for half-fixed angle positioning.

NOTE

1 This parameter is valid when bit 6 (ESI) of parameter No.4950=1.

2 Make sure that M codes from $M\alpha$ to $M(\alpha+\beta-1)$ do not duplicate other M codes.

3 Setting this parameter to 0 has the same effect as setting 6. That is, M code from $M\alpha$ to $M(\alpha+5)$ are used for half-fixed angle positioning.

4970

Servo loop gain of the spindle

[Data type] Word**[Unit of data]** 0.01 s^{-1} **[Valid data range]** 1 to 9999

Set the servo loop gain of the spindle in the spindle positioning mode.

4971	Servo loop gain multiplier of the spindle for gear 1
4972	Servo loop gain multiplier of the spindle for gear 2
4973	Servo loop gain multiplier of the spindle for gear 3
4974	Servo loop gain multiplier of the spindle for gear 4

[Data type] Word

Set the servo loop gain multipliers of the spindle for gears 1 to 4.

The multipliers are used to convert the amount of the position deviation to the voltage used in the velocity command. Assign the data obtained from the following equation to the parameters.

$$\text{Loop gain multiplier} = 2048000 \times E \times A/L$$

where;

E : Voltage required to rotate the spindle motor at 1000 min⁻¹ in the velocity command

L : Rotation angle of the spindle per one motor rotation (normally 360)

A : Unit used for the detection (degree)

Example

Let E be 2.2 V, L be 360 degrees, and A be 0.088 degrees/pulse.

$$\text{Loop gain multiplier} = 2048000 \times 2.2 \times 0.088/360 = 1101$$

* When the voltage specified for the spindle motor is 10 V at a spindle speed of 4500 min⁻¹, E is regarded as 2.2 V.

NOTE

The above parameters No.4970 to No.4974 are for analog spindles.

4.24 PARAMETERS OF TOOL COMPENSATION

5000	#7	#6	#5	#4	#3	#2	#1	#0
								SBK

[Data type] Bit

SBK In HPCC mode, an internally created block for cutter compensation:
 0 : Does not cause a single block stop.
 1 : Causes a single block stop.

5001	#7	#6	#5	#4	#3	#2	#1	#0
		EVO	TPH	EVR	TAL	OFH	TLB	TLC

[Data type] Bit type

TLC Tool length compensation
 0 : Tool length compensation A or B (Conforms to TLB in parameter No.5001)
 1 : Tool length compensation C

TLB Tool length compensation axis
 0 : Always Z axis irrespective of plane specification (Tool length compensation A)
 1 : Axis perpendicular to plane specification (G17, G18, and G19) (Tool length compensation B)

OFH Offset number of tool length compensation, cutter compensation and tool offset
 0 : Specifies the tool length compensation using an H code, and cutter compensation C using a D code
 Tool offset conforms to TPH in parameter No.5001#5.
 1 : Specifies the tool length compensation, cutter compensation and tool offset using H codes

NOTE
 Be sure to set this parameter to 1 for cutter compensation B.

TAL Tool length compensation C
 0 : Generates an alarm when two or more axes are offset
 1 : Not generate an alarm even if two or more axes are offset

EVR When a tool compensation value is changed in cutter compensation C mode:
 0 : Enables the change, starting from that block where the next D or H code is specified.
 1 : Enables the change, starting from that block where buffering is next performed.

TPH Specifies whether address D or H is used as the address of tool offset number (G45 to G48).
 0 : D code
 1 : H code

TPH is valid when OFH in parameter No.5001#2 is 0.

EVO Specifies whether an offset is effective in the next block to be buffered or the next block for which an H code is specified when the offset value is changed in tool length offset A or B.

0 : Next block in which an H code is specified.

1 : Next block to be buffered.

	#7	#6	#5	#4	#3	#2	#1	#0
5002	WNP	LWM	LGC	LGT		LWT	LGN	LD1

[Data type] Bit

LD1 Offset number of tool offset (Wear offset number when option of tool geometry/wear compensation is selected)

0 : Specified using the lower two digits of a T code

1 : Specified using the lower one digit of a T code

LGN Geometry offset number of tool offset (When the option of tool geometry/wear compensation is selected, it is effective.)

0 : Is the same as wear offset number

1 : Specifies the geometry offset number by the tool selection number

LWT Tool wear compensation is performed by:

0 : Moving the tool.

1 : Shifting the coordinate system.

(Only when the LGT parameter (bit 4 of No.5002) is set to 0)

LGT Tool geometry compensation (When the option of tool geometry/wear compensation is selected, this parameter is effective. Whenever the option is not selected, compensation is made according to the tool movement.

0 : Compensated by the shift of the coordinate system (Compensation is made in the block of T code regardless of LWM at this time.)

1 : Compensated by the tool movement

LGC Tool geometry compensation (It is effective when the option of tool geometry / wear compensation is selected and LGT = 0. When LGT is 1, it is always canceled.)

0 : Not canceled by offset number 0

1 : Canceled by offset number 0

LWM Tool offset (Wear compensation when option of tool geometry/wear offset is selected, or geometry and wear compensation when LGT = 1.)

0 : is done in the T code block

1 : is done together with the axis movement

NOTE

When the option of tool geometry/wear compensation is equipped and LGT = 0, the offset is done in a T code block regardless of this parameter.

WNP Imaginary tool tip direction used for tool nose radius compensation, when the geometry/wear compensation option is equipped, is the direction specified by:

0 : Geometry offset number

1 : Wear offset number

	#7	#6	#5	#4	#3	#2	#1	#0
5003	TGC	LVC				CCN		
		LVK		BCK	ICK	CCN	SUV	SUP

[Data type] Bit

- SUP** Start up or cancel in cutter compensation C
0 : Type A
1 : Type B
- SUV** When G40, G41, and G42 are specified independently,
0 : The start up and cancel operation conforms to the standard specification.
1 : Moves by a distance corresponding to the offset vector which is vertical to the next block movement. Specifying G40 alone results in the offset cancel operation.
- CCN** When automatic reference position return (G28) is specified in the cutter compensation C mode (M series) or in tool nose radius compensation (T series):
0 : The tool nose radius compensation vector is cancelled in movement to an intermediate position.
1 : The tool nose radius compensation vector is not cancelled in movement to an intermediate position, but is cancelled in movement to the reference position.
- ICK** In HPCC mode, a cutter compensation interference check is:
0 : Done
1 : Not done
- BCK** In HPCC mode, when a cutter compensation interference check determines that the programmed move direction differs from the offset move direction by between 90 and 270 degrees:
0 : An alarm is issued.
1 : No alarm is issued.
- LVC** Offset value of tool offset
0 : Not cleared, but held by reset
1 : Cleared by reset
- LVK** Tool length offset value
0 : Cleared by reset
1 : Not cleared, but held by reset
- TGC** Tool geometry compensation value
0 : Not canceled by reset
1 : Canceled by reset
(Valid when LVC, #6 of parameter No.5003, is “1”)

	#7	#6	#5	#4	#3	#2	#1	#0
5004	Y03				TS1		ORC	
						ODI		

NOTE

When this parameter is set, the power must be turned off before operation is continued.

[Data type] Bit**ORC** Tool offset value

0 : Set by the diameter specification

(Can be set in only the axis under diameter programming)

1 : Set by the radius specification

ODI A cutter compensation amount is set using:

0 : A radius.

1 : A diameter.

TS1 When the tool offset measurement value direct input B function is used, touch sensor contact detection is based on:

0 : Four-contact input.

1 : One-contact input.

Y03 Y axis offset is :

0 : Used for 4th axis.

1 : Used for 3rd axis.

	#7	#6	#5	#4	#3	#2	#1	#0
5005		TLE	QNI			PRC		CNI

[Data type] Bit**CNI** On the offset screen, Y-axis offset screen, and macro screen, the **[INP.C]** soft key is:

0: Used.

1: Not used. (The **[INP.C]** soft key is not displayed.)

PRC Direct input of tool offset value and workpiece coordinate-system shift value

0 : Not use a PRC signal

1 : Uses a PRC signal

QNI In the function of input of offset value measured B or tool setter function for 1-turret, 2-spindle lathes

0 : Not automatically select the tool offset number

1 : Automatically selects a tool offset number

TLE When the tool offset measurement value direct input B function is used, a tool offset value, set by the offset write signal, is:

0 : Always received in offset write mode.

1 : Received only in offset write mode and during movement along an axis (where "during movement along an axis" means that the positional deviation value is other than 0).

	#7	#6	#5	#4	#3	#2	#1	#0
5006							TGC	OIM
								OIM

[Data type] Bit

OIM When the unit is switched between the inch and metric systems, automatic tool offset value conversion is:
 0 : Not performed
 1 : Performed

NOTE
 If this parameter setting is changed, reset the tool offset data.

TGC When a T code is specified in a block containing G50, G04, or G10:
 0 : No alarm occurs.
 1 : P/S alarm No.245 occurs.

	#7	#6	#5	#4	#3	#2	#1	#0
5007								
	3OF	3OC						

[Data type] Bit

3OC If tool length compensation is not cancelled before three-dimensional coordinate conversion is specified, an alarm is:
 0 : Not raised.
 1 : Raised. (P/S049 alarm)

3OF If the commands of three-dimensional coordinate conversion and tool length compensation are not nested, an alarm is:
 0 : Not raised.
 1 : Raised. (P/S049 alarm)

Example 1) An alarm is raised in the following cases:

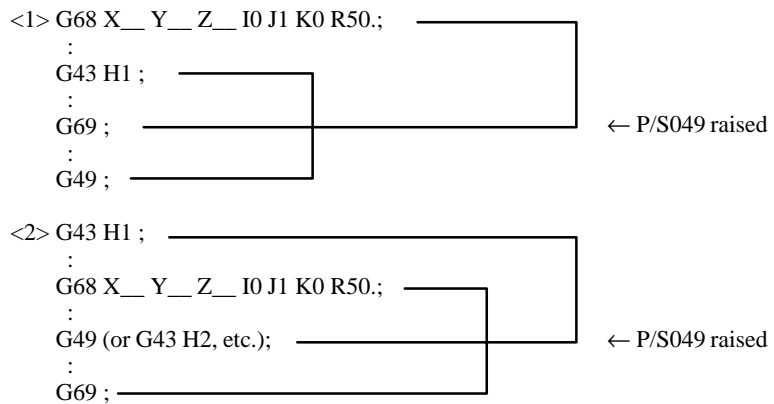

Example 2) No alarm is raised in the following cases:

```

<3> G68 X__ Y__ Z__ I0 J1 K0 R50.;
      :
      G43 H1 ;
      :
      G49 ;
      :
      G69 ;

<4> G43 H1 ;
      :
      G68 X__ Y__ Z__ I0 J1 K0 R50.;
      :
      G69 ;
      :
      G49 ;
    
```

NOTE

To program as in <4> of Example 2) above, set both bit 2 (D3R) of parameter No. 5400 and bit 6 (LVK) of parameter No. 5003 to 1, so that three-dimensional coordinate conversion and tool length compensation are not cancelled by a reset. (If a reset is made in the middle of a program, the direction of tool length compensation will be affected.) As shown below, a command to cancel tool length compensation (G28, etc.) will not cause an alarm to be raised. If a command like this is specified in the G68 mode, program as indicated in <3> above.

```

      G43 H1 ;
      :
      G68 X__ Y__ Z__ I0 J1 K0 R50.;
      :
      G28 X__ Y__ Z__ ;
      :
      G69 ;
    
```

← Offset is cancelled.
No alarm is raised.

	#7	#6	#5	#4	#3	#2	#1	#0
5008			QCR	MCR	CNV		CNC	CNI
		GCS	QCR	MCR	CNV	G39	CNC	CNI

[Data type] Bit

CNI Interference check for cutter compensation C (M series) or tool-tip radius compensation (T series) is:

- 0 : Performed
- 1 : Not performed

CNC During interference check for cutter compensation C (M series) or tool-tip radius compensation (T series), when the direction of movement after application of the offset differs from the programmed direction by between 90° and 270°:

- 0 : An alarm is issued.
- 1 : No alarm is issued.

G39 The corner rounding function (G39) in cutter compensation C mode is:

- 0 : Disabled.
- 1 : Enabled.

CNV The interference check and vector erasure of cutter compensation C (M series) or tool–nose radius compensation (T series) are:

0 : Performed.

1 : Not performed.

MCR If G41/G42 (cutter compensation C (M series) or tool–nose radius compensation (T series)) is specified in the MDI mode, an alarm is:

0 : Not raised.

1 : Raised. (P/S5257)

NOTE

In the MDI mode, cutter compensation C (M series) or tool–nose radius compensation (T series) is not performed, irrespective of the setting of this parameter.

QCR The travel distance of circular interpolation in cutter compensation C (M series) or tool–nose radius compensation (T series) is judged:

0 : In the FS16 format.

1 : In the FS15 format.

FS16 and FS15 determine the travel distance in different ways if the radius of arc at the start point of circular interpolation is different from that at the end point (if the end point is not on the arc). By this parameter, the method of determining the travel distance of circular interpolation can be selected.

[FS16 format]

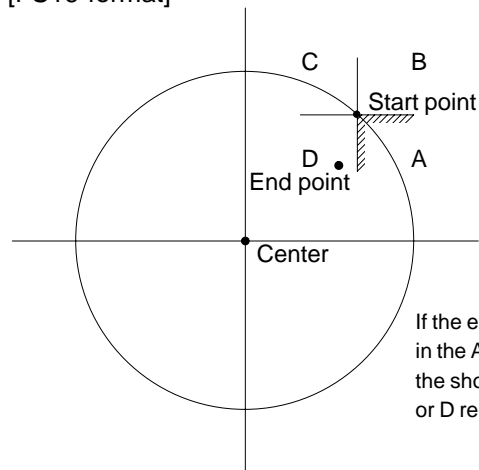

If the end point viewed from the start point is in the A region, the movement is made along the shortcut. If the end point is in the B, C, or D region, almost a single turn is made.

[FS15 format]

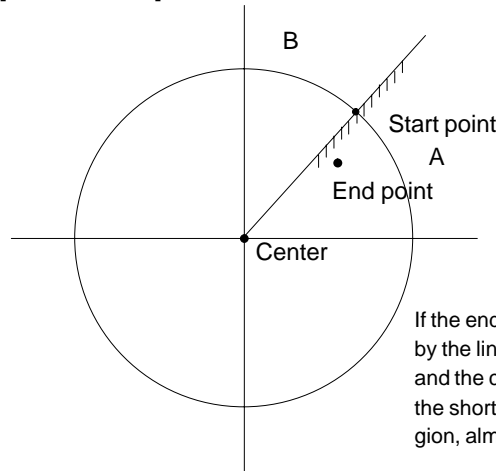

If the end point is in the A region separated by the line L drawn between the start point and the center, the movement is made along the shortcut. If the end point is in the B region, almost a single turn is made.

NOTE

The setting of this parameter determines the travel distance determination method for circular interpolation not during cutter compensation C (M series) or tool-nose radius compensation (T series) as well. Accordingly, if this parameter is set, the setting of bit 3 (CQD) of parameter No. 3450 is invalid.

GCS If G49 (G code for canceling tool length compensation) and G40 (G code for canceling cutter compensation) are specified in a single block, the tool length compensation is cancelled:

- 0 : In the next block.
- 1 : In the specified block.

	#7	#6	#5	#4	#3	#2	#1	#0
5009								GSG

NOTE

When this parameter has been set, the power must be turned off before operation is continued.

[Data type] Bit

GSG In the mode of tool compensation direct input B, the offset write input signal is input:

- 0 : From the machine side. <G004 bits 2 to 5>
- 1 : From the PMC side. <G132 bits 0 and 1, G134 bits 0 and 1>

5010	Limit value that ignores the vector when a tool moves on the outside of a corner during tool nose radius compensation
	Limit value that ignores the vector when a tool moves on the outside of a corner during cutter compensation C

[Data type] Word

[Unit of data]

Increment system	IS-A	IS-B	IS-C	Unit
Millimeter input	0.01	0.001	0.0001	mm
Inch input	0.001	0.0001	0.00001	inch

[Valid data range] 0 to 16383

This parameter sets the limit value that ignores a slight movement occurring when a tool moves on the outside of the corner during cutter compensation C.

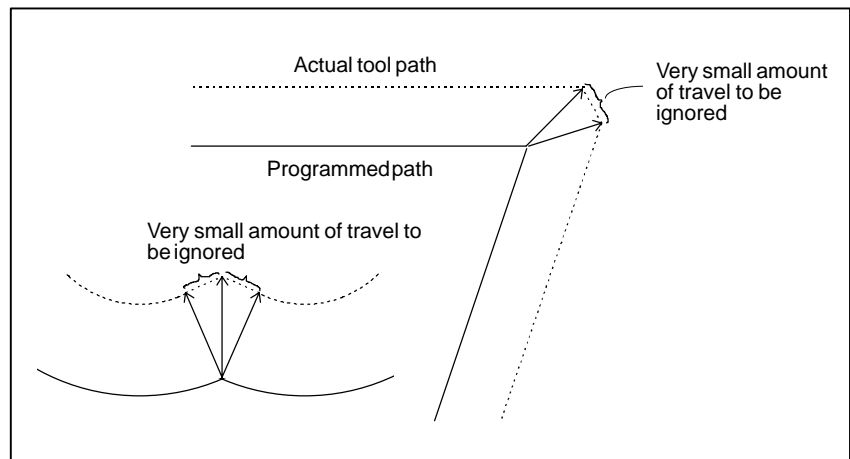

5011	
	Denominator constant for finding a three-dimensional tool compensation vector

[Data type] 2-word

[Unit of data]

Increment system	IS-A	IS-B	IS-C	Unit
Millimeter input	0.01	0.001	0.0001	mm
Inch input	0.001	0.0001	0.00001	inch

[Valid data range] -99999999 to 99999999

This parameter sets the value of p in the expressions used for finding a three-dimensional tool compensation vector:

$$V_x = i \times r/p$$

$$V_y = j \times r/p$$

$$V_z = k \times r/p$$

where,

V_x, V_y, V_z : Components of a three-dimensional tool compensation vector along the X-axis, Y-axis, and Z-axis, or their parallel axes

i, j, k : Values specified in addresses I, J, and K in the program

r : Compensation value

p : Value set in this parameter

When 0 is set in this parameter, the following is assumed:

$$p = \sqrt{i^2 + j^2 + k^2}$$

5013

Maximum value of tool wear compensation

[Data type] 2-word

[Unit of data]

Increment system	IS-B	IS-C	Units
Millimeter input	0.001	0.0001	mm
Inch input	0.0001	0.00001	inch

[Valid data range]

Increment system	IS-B	IS-C
Millimeter input	0 to 999999	0 to 9999999
Inch input	0 to 999999	0 to 9999999

This parameter sets the maximum allowable tool wear compensation value. If an attempt is made to set a tool wear compensation value, the absolute value of which exceeds the value set in this parameter, the following alarm or warning is output:

Input from MDI Warning: Too many digits

Input by G10 P/S alarm No.032: Offset value is out of range by G10.

5014

Maximum value of incremental input for tool wear compensation

[Data type] 2-word

[Unit of data]

Increment system	IS-B	IS-C	Units
Millimeter input	0.001	0.0001	mm
Inch input	0.0001	0.00001	inch

[Valid data range]

Increment system	IS-B	IS-C
Millimeter input	0 to 999999	0 to 9999999
Inch input	0 to 999999	0 to 9999999

Set the maximum allowable value for the tool wear compensation value, input as an incremental value. If the incremental input value (absolute value) exceeds the set value, the following alarm or warning message is output:

Input from MDI Warning: Setting value out of range.

Input using G10 P/S alarm No.032: Offset value is out of range by G10.

5015	Distance (XP) between reference position and X axis + contact surface
5016	Distance (XM) between reference position and X axis - contact surface
5017	Distance (ZP) between reference position and Z axis + contact surface
5018	Distance (ZM) between reference position and Z axis - contact surface

[Data type] 2-word

[Unit of data]

Increment system	IS-A	IS-B	IS-C	Unit
Millimeter input	0.01	0.001	0.0001	mm
Inch input	0.001	0.0001	0.00001	inch

[Valid data range] -99999999 to 99999999

These parameters are related to the function of input of tool offset value measured B or tool setter function for 1-turret, 2-spindle lathes.

They set the distance (with sign) between the measurement reference position and sensor contact surface. For an axis under diameter programming, set it by a diameter value.

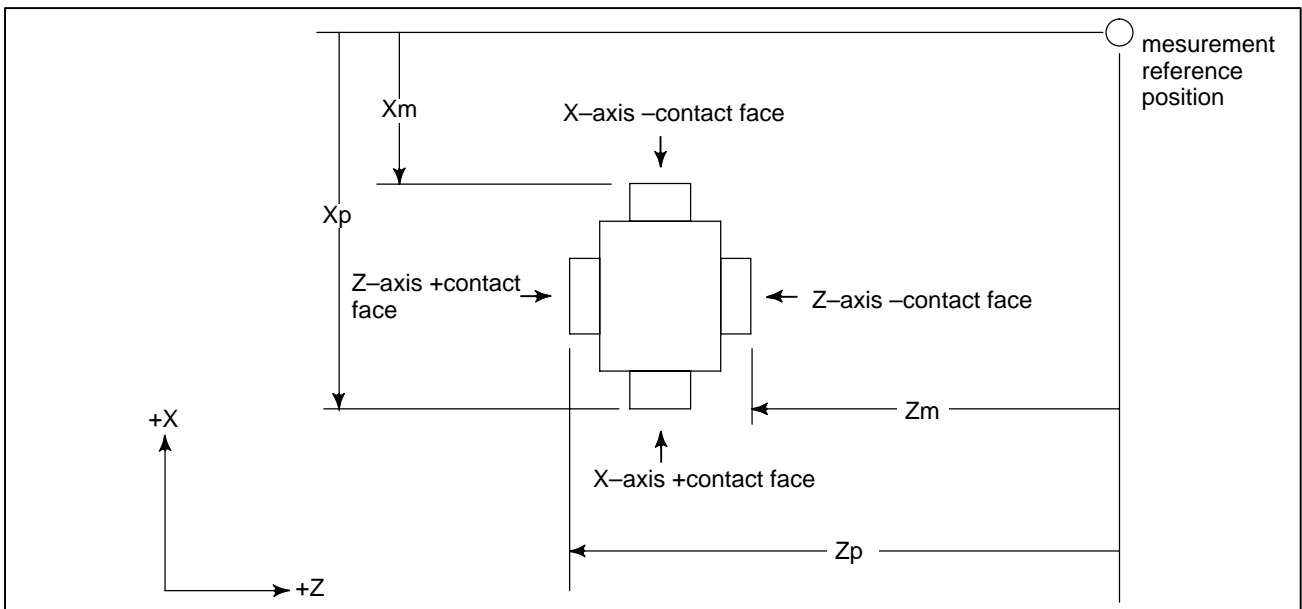

Fig.4.24 Distance along X and Z Axes from the Reference Position to +/- Contact Surfaces

NOTE

When the tool setter function for 1-turret, 2-spindle lathes is used with two touch sensors, set the distance of touch sensor 1. For touch sensor 2, set parameter No.5056 through No.5059.

5020	Tool offset number used for the input of tool offset value measured B

[Data type] Byte

[Valid data range] 0 to the number of tools to be compensated.

Set tool offset number used for the input of tool offset value measured B function or tool setter function for 1-turret, 2-spindle lathes (i.e. when workpiece coordinate system shift value is set). (The tool offset number corresponding to the measured tool shall be set in advance.) This parameter is valid when the tool offset number is not selected automatically (QNI, #5 of parameter 5005, is zero).

5021	Number of pulse interpolation cycles memorized prior to contacting the touch sensor

[Data type] Byte

[Unit of data] Interpolation cycle

[Valid data range] 0 to 8

This parameter sets the number of pulse interpolation cycles to be memorized until the operator manually touches the tool with a one-contact input touch sensor when the tool offset measurement value direct input B function is used.

If 0 is set for this parameter, the specification of 8 (maximum allowable value) is assumed.

NOTE

This parameter is enabled when the TS1 parameter (bit 3 of parameter No.5004) is set to 1.

5030	
	Minimum grinding wheel diameter in minimum grinding wheel diameter check

[Data type] 2-word

[Unit of data]

Increment system	IS-A	IS-B	IS-C	Unit
Millimeter input	0.01	0.001	0.0001	mm
Input in inches	0.001	0.0001	0.00001	inch

[Valid data range]

Increment system	IS-A, IS-B	IS-C
Millimeter input	-999999 to 999999	-9999999 to 9999999
Input in inches	-999999 to 999999	-9999999 to 9999999

If the compensation value corresponding to an offset number specified by an H code is smaller than the minimum grinding wheel diameter specified in this parameter during compensation with G43 or G44, the signal F0065#3 GWLF is output to the PMC.

NOTE

This is a parameter for cylindrical grinding machines.

	#7	#6	#5	#4	#3	#2	#1	#0
5040								OWD

NOTE
When this parameter has been set, the power must be turned off before operation is continued.

[Data type] Bit

OWD In radius programming (bit 1 (ORC) of parameter No. 5004 is set to 1),
 0 : Tool offset values of both geometry compensation and wear compensation are specified by radius.
 1 : Tool offset value of geometry compensation is specified by radius and tool offset value of wear compensation is specified by diameter, for an axis of diameter programming.

	#7	#6	#5	#4	#3	#2	#1	#0
5051							WNI	DSN

[Data type] Bit

DSN When the tool setter function for 1–turret, 2–spindle lathes is used:
 0 : One touch sensor is used for both main spindle 1 and main spindle 2.
 1 : Two touch sensors are used for both main spindle 1 and main spindle 2.

WNI When a workpiece reference point offset value is set in workpiece coordinate system memory with the tool setter function for 1–turret, 2–spindle lathes:
 0 : The value is set at the current cursor position.
 1 : A memory is automatically selected. (The workpiece coordinate system memory set in parameter No.5054 or No.5055 is selected.)

5053	Bias for tool offset numbers for measured tool offset value setting
------	---

[Data type] Byte

[Unit of data] Number

[Valid data range] 1 to maximum tool offset count

When the tool setter function for 1–turret, 2–spindle lathes is used, this parameter allocates tool offset numbers for measured tool offset measurement values to spindle 1 and spindle 2.

Example: When the tool offset count is 16 pairs

	Tool offset number	
	When setting = 8	When setting = 10
Spindle 1	1 to 8	1 to 10
Spindle 2	9 to 16	11 to 16

If 0 is set for this parameter, or if the maximum tool offset count is exceeded, the following is assumed:

	Tool offset number			
	16 pairs	32 pairs	64 pairs	99 pairs
Spindle 1	1 to 8	1 to 16	1 to 32	1 to 49
Spindle 2	9 to 16	17 to 32	33 to 64	50 to 98

5054	Workpiece coordinate system memory for spindle 1
5055	Workpiece coordinate system memory for spindle 2

[Data type] Byte

[Unit of data] Number

[Valid data range] 54 to 59

When the WNI parameter (bit 1 of parameter No.5051) is set to 1 specify, in each of these parameters, a workpiece coordinate system from G54 to G59 for workpiece reference point offset value setting.

NOTE

If the value set in this parameter is 0, or if the value falls outside the valid data range, 54 is assumed for the workpiece coordinate system memory for spindle 1, while 57 is assumed for the workpiece coordinate system memory for spindle 2.

5056	X-axis + (distance to contact surface) on the touch sensor 2 side (XP)
5057	X-axis - (distance to contact surface) on the touch sensor 2 side (XM)
5058	Z-axis + (distance to contact surface) on the touch sensor 2 side (ZP)
5059	Z-axis - (distance to contact surface) on the touch sensor 2 side (ZM)

[Data type] 2-word

[Unit of data]

Increment system	IS-B	IS-C	Units
Millimeter machine	0.001	0.0001	mm
Inch machine	0.0001	0.00001	inch

[Valid data range] -99999999 to 99999999

When two touch sensors are used with the tool setter function for 1-turret, 2-spindle lathes, each parameter sets the distance (with a sign) between the measurement reference position on touch sensor 2 and each sensor contact surface. For an axis subject to diameter specification, specify a diameter.

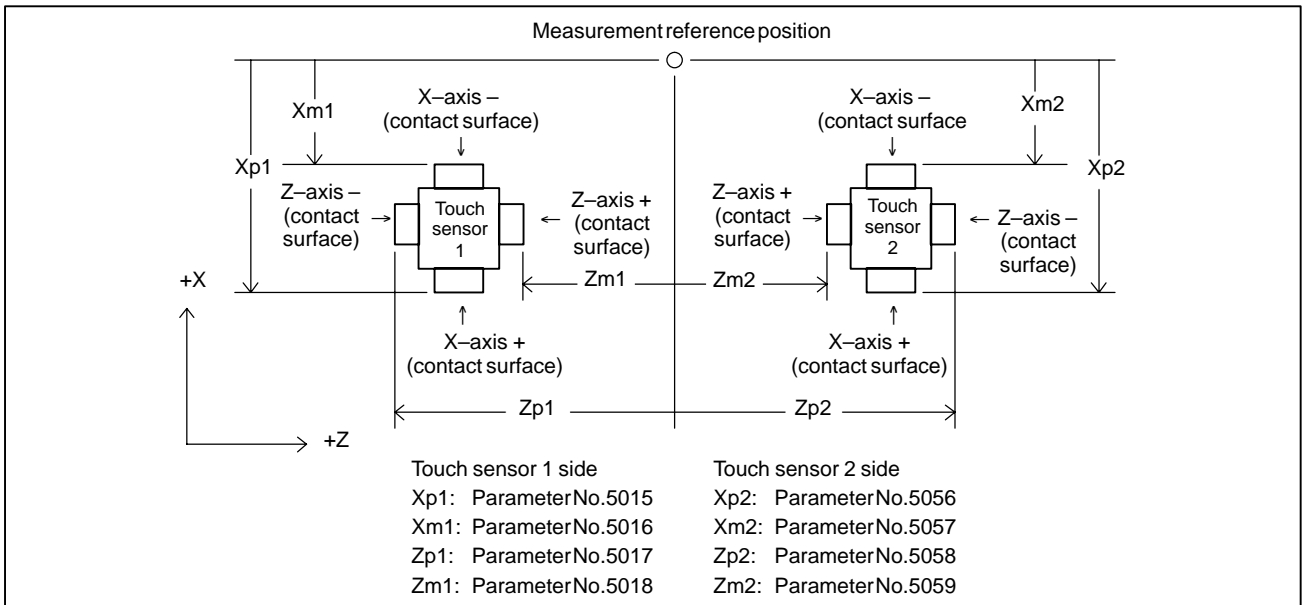

NOTE

These parameters are enabled when the DSN parameter (bit 0 of parameter No.5051) is set to 1. Set the data for touch sensor 1 in parameter No.5015 through No.5018.

4.25 PARAMETERS OF GRINDING-WHEEL WEAR COMPENSATION

5071	
	Number of first axis for grinding-wheel wear compensation
5072	
	Number of second axis for grinding-wheel wear compensation

[Data type] Byte

[Valid data range] 1 to the number of controlled axes

These parameters specify the controlled axis numbers of the first and second axes for which grinding-wheel wear compensation is applied.

5081	
	Coordinate of first compensation center along first axis on compensation plane
5082	
	Coordinate of first compensation center along second axis on compensation plane
5083	
	Coordinate of second compensation center along first axis on compensation plane
5084	
	Coordinate of second compensation center along second axis on compensation plane
5085	
	Coordinate of third compensation center along first axis on compensation plane
5086	
	Coordinate of third compensation center along second axis on compensation plane

[Data type] 2-word

[Unit of data]

Increment system	IS-A	IS-B	IS-C	Unit
Millimeter input	0.01	0.001	0.0001	mm
Inch input	0.001	0.0001	0.00001	inch

[Valid data range] -99999999 to 99999999

These parameters specify the coordinates (in the workpiece coordinate system) of the compensation center for grinding-wheel wear compensation.

4.26 PARAMETERS OF CANNED CYCLES

4.26.1 Parameter of canned Cycle for Drilling

	#7	#6	#5	#4	#3	#2	#1	#0
5101		M5T			ILV	RTR		FXY
	M5B	M5T	RD2	RD1			EXC	FXY

[Data type] Bit

FXY The drilling axis in the drilling canned cycle is:
0 : Always the Z-axis
1 : The axis selected by the program

NOTE

In the case of the T series, this parameter is valid only for the drilling canned cycle in the Series 15 format.

EXC G81
0 : Specifies a drilling canned cycle
1 : Specifies an external operation command

RTR G83 and G87
0 : Specify a high-speed peck drilling cycle
1 : Specify a peck drilling cycle

ILV Initial point position in drilling canned cycle
0 : Not updated by reset
1 : Updated by reset

RD2, RD1 Set the axis and direction in which the tool in drilling canned cycle G76 or G87 is got free. RD2 and RD1 are set as shown below by plane selection.

RD2	RD1	G17	G18	G19
0	0	+X	+Z	+Y
0	1	-X	-Z	-Y
1	0	+Y	+X	+Z
1	1	-Y	-X	-Z

M5T When a spindle rotates from the forward to the reverse direction and vice versa in tapping cycles G84 and G74 for M series (G84 and G88 for T series), before M04 or M03 is output:

For T series

0 : Not output M05
1 : Outputs M05

For M series

0 : Outputs M05
1 : Not output M05

M5B In drilling canned cycles G76 and G87:
0 : Outputs M05 before an oriented spindle stops
1 : Not output M05 before an oriented spindle stops

	#7	#6	#5	#4	#3	#2	#1	#0
5102	RDI	RAB	K0E	RFC	F16	QSR	MRC	

[Data type] Bit

MRC When a target figure other than a monotonically increasing or monotonically decreasing figure is specified in a multiple repetitive turning canned cycle (G71, G72):

0 : No alarm occurs.

1 : P/S alarm No.064 is occurs.

NOTE

This parameter is valid for multiple repetitive turning canned cycle type I.

QSR Before a multiple repetitive canned cycle (G70 to G73) is started, a check to see if the program contains a block that has the sequence number specified in address Q is:

0 : Not made.

1 : Made. (If the sequence number specified in address Q cannot be found, an alarm occurs and the canned cycle is not executed.)

F16 When the Series 15 format is used (with bit 1 (FCV) of parameter No.0001 set to 1), a canned drilling cycle is specified using :

0 : Series 15 format

1 : Series 16 format. (However, the number of repetitions is specified using address L.)

RFC For the semifinish figure of G71 or G72 and for a cutting pattern of G73, tool-nose radius compensation is:

0 : Not performed.

1 : Performed.

K0E When K0 is specified in a hole machining canned cycle (G80 to G89):

0 : Hole machining is performed once.

1 : Hole machining is not performed. Instead, the hole machining data is merely memorized.

RAB The R command for the drilling canned cycle in the Series 15 format is:

0 : Regarded as an incremental command

1 : Regarded as:

An absolute command in the case of G code system A

An absolute command in the case of G code system B or C when the G90 mode is specified.

An incremental command in the case of G code system B or C when the G91 mode is specified.

RDI The R command for the drilling canned cycle in the Series 15 format:

0 : Is regarded as the specification of a radius

1 : Follows the specification of a diameter/radius for the drilling axis

	#7	#6	#5	#4	#3	#2	#1	#0
5103		TCZ			PNA	P15	TFD	
		TCZ					QZA	SIJ

[Data type] Bit

SIJ When the FS15 command format is used, a tool shift value for the drilling canned cycle G76 or G87 is specified by:

- 0 : Address Q
- 1 : Address I, J, or K

TFD During a threading cycle, feed forward is:

- 0 : Enabled.
- 1 : Disabled.

QZA When the specification of the depth of cut (Q) for each time is omitted, or if Q0 is specified in a high-speed peck drilling canned cycle (G73) or peck drilling canned cycle (G83):

- 0 : No alarm is issued.
- 1 : An alarm (No.045) is issued.

P15 When the FS15 command format is used, the machining sequence for pocketing using multiple repetitive canned cycle G71 or G72 follows:

- 0 : FS16 specification
- 1 : FS15 specification

PNA If the FS15 tape format is used and if a plane without an axis is specified in the canned cycle mode of drilling, an alarm is:

- 0 : Raised. (P/S 028)
- 1 : Not raised.

TCZ In a tapping cycle (excluding rigid tapping), an accumulated zero check in the tapping step (forward, backward) is:

- 0 : Not performed.
- 1 : Performed.

Execute a tapping cycle (excluding rigid tapping) with the servo feed forward (bit 1 of parameter No. 2005). If an impact is detected, set this parameter to 1.

	#7	#6	#5	#4	#3	#2	#1	#0
5104						FCK	BCR	

[Data type] Bit

BCR In a boring cycle, retraction is made:

- 0 : At a cutting feedrate.
- 1 : At a rapid traverse rate.

FCK In a multiple repetitive canned cycle (G71/G72), the machining profile is:

- 0 : Not checked.
- 1 : Checked.

If this parameter is specified, the machining profile specified in the multiple repetitive canned cycle for lathe (G71/G72) and the machining start point are checked. If the relationship is incorrect, the P/S 062 alarm is raised.

An incorrect relationship between the machining profile and machining start point indicates either of the following cases.

- Although the finishing allowance is specified with a positive sign, the start point of the canned cycle is smaller than the maximum value of the machining profile.
- Although the finishing allowance is specified with a negative sign, the start point of the canned cycle is larger than the minimum value of the machining profile.

NOTE

- 1 The machining profile is checked before the operation of the canned cycle (not during machining).
- 2 The machining profile to be checked is a programmed profile. The path of retraction or return is not checked.
- 3 This parameter is not valid for G71 or G72 of the canned cycle for grinder.

5110	C-axis clamp M code in drilling canned cycle

[Data type] Byte

[Valid data range] 0 to 99

This parameter sets the C-axis clamp M code in a drilling canned cycle.

5111	Dwell time when C-axis unclamping is specified in drilling canned cycle

[Data type] Word

[Unit of data] ms

[Valid data range] 0 to 32767

This parameter sets the dwell time when C-axis unclamping is specified in a drilling canned cycle.

5112	Spindle forward-rotation M code in drilling canned cycle

[Data type] Byte

[Valid data range] 0 to 255

This parameter sets the spindle forward-rotation M code in a drilling canned cycle.

NOTE

M03 is output when "0" is set.

5113	Spindle reverse-rotation M code in drilling canned cycle

[Data type] Byte

[Valid data range] 0 to 255

This parameter sets the spindle reverse-rotation M code in a drilling canned cycle.

NOTE

M04 is output when "0" is set.

5114	Return or clearance value of drilling canned cycle G83
	Return value of high-speed peck drilling cycle G73

[Data type] Word

[Unit of data]

Increment system	IS-A	IS-B	IS-C	Unit
Millimeter input	0.01	0.001	0.001	mm
Inch input	0.001	0.0001	0.0001	inch

[Valid data range] 0 to 32767

For M series this parameter sets the return value in high-speed peck drilling cycle G73 (G83 for T series).

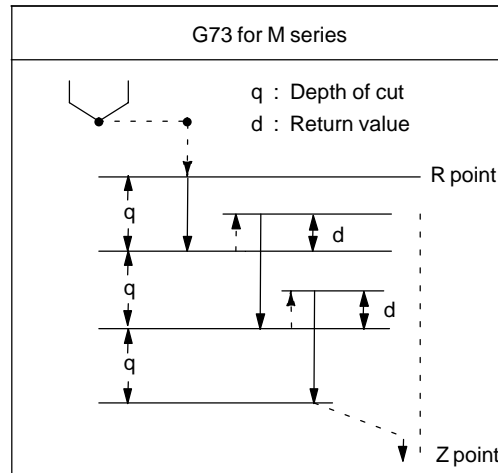

Fig.4.26.1 (a) High-speed Peck Drilling Cycle G73

For T series this parameter sets the return or clearance value in drilling canned cycle G83.

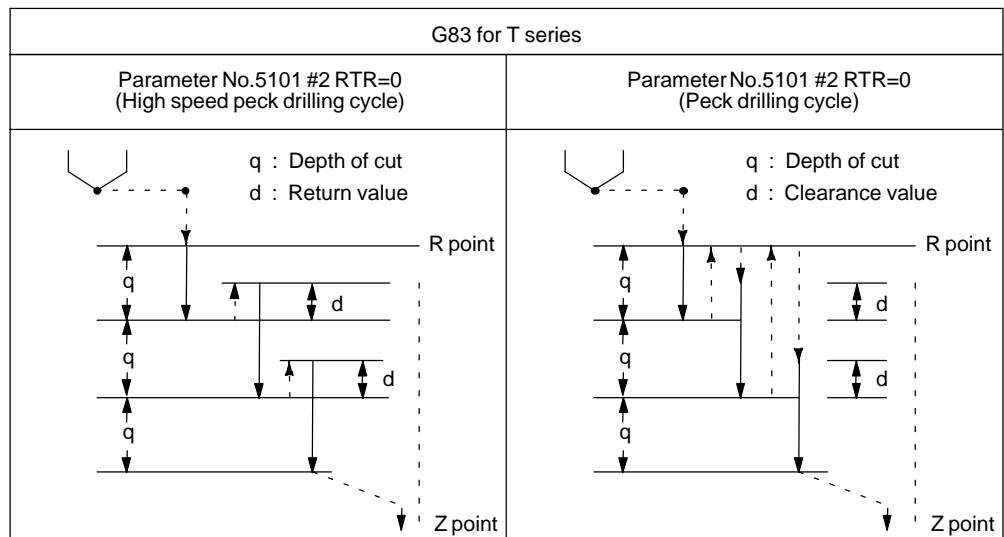

Fig.4.26.1 (b) Drilling Canned Cycle G83

5115	
	Clearance of canned cycle G83

[Data type] Word

[Unit of data]

Increment system	IS-A	IS-B	IS-C	Unit
Millimeter input	0.01	0.001	0.001	mm
Inch input	0.001	0.0001	0.0001	inch

[Valid data range] 0 to 32767

This parameter sets the clearance of peck drilling cycle G83.

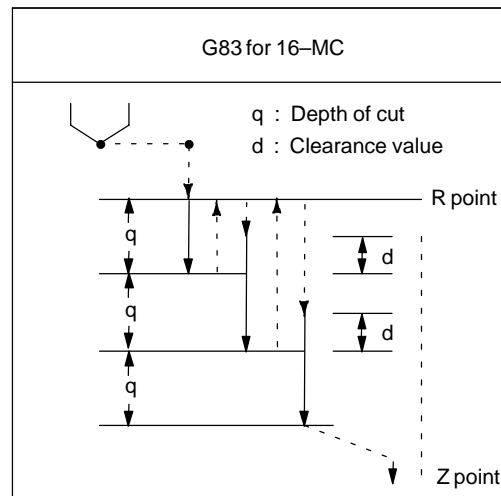

Fig.4.26.1 (c) Peck drilling cycle G83

5121	
	Override value for retraction in boring cycle (G85, G89)

[Data type] Byte

[Unit of data] 100%

[Valid data range] 0.1 to 20

Set the override value of retraction in a boring cycle.
 If 20 or a greater value is specified in this parameter, the override is set to 2000%. If 0 is specified, this parameter becomes invalid, and the retraction speed becomes two times the cutting speed.

4.26.2**Parameter of Thread Cutting Cycle**

5130	Chamfering distance in the thread cutting cycles G76 and G92

[Data type] Byte

[Unit of data] 0.1 pitch

[Valid data range] 0 to 127

This parameter sets the chamfering in the thread cutting cycles G76 and G92.

5131	Chamfering angle in threading cycle

[Data type] Byte

[Unit of data] 1 deg

[Valid data range] 1 to 89

Set a chamfering angle in a threading cycle.

4.26.3**Parameter of Multiple Repetitive Canned Cycle**

5132	Depth of cut in multiple repetitive canned cycles G71 and G72

[Data type] 2-word

[Unit of data]

Increment system	IS-B	IS-C	Unit
Millimeter input	0.001	0.001	mm
Inch input	0.0001	0.0001	inch

[Valid data range] 0 to 99999999

This parameter sets the depth of cut in multiple repetitive canned cycles G71 and G72.

5133	Escape in multiple repetitive canned cycles G71 and G72.

[Data type] 2-word

[Unit of data]

Increment system	IS-B	IS-C	Unit
Millimeter input	0.001	0.001	mm
Inch input	0.0001	0.0001	inch

[Valid data range] 0 to 99999999

This parameter sets the escape in multiple repetitive canned cycle G71 and G72.

5135	Escape in multiple repetitive canned cycle G73 in X-axis direction

5136	Escape in multiple repetitive canned cycle G73 in Z-axis direction

[Data type] 2-word

[Unit of data]

Increment system	IS-B	IS-C	Unit
Input in mm	0.001	0.001	mm
Input in inches	0.0001	0.0001	inch

[Valid data range] -99999999 to 99999999

This parameter sets the escape in multiple repetitive canned cycle G73 of an X, then Z axis.

5137	Division count in multiple repetitive canned cycle G73

[Data type] 2-word

[Unit of data] Cycle

[Valid data range] 1 to 99999999

This parameter sets the division count in multiple repetitive canned cycle G73.

5139	Return in multiple canned cycles G74 and G75

[Data type] 2-word

[Unit of data]

Increment system	IS-B	IS-C	Unit
Metric input	0.001	0.001	mm
Inch input	0.0001	0.0001	inch

[Valid data range] 0 to 99999999

This parameter sets the return in multiple repetitive canned cycles G74 and G75.

5140	Minimum depth of cut in the multiple repetitive canned cycle G76

[Data type] 2-word

[Unit of data]

Increment system	IS-B	IS-C	Unit
Metric input	0.001	0.0001	mm
Inch input	0.0001	0.00001	inch

[Valid data range] 0 to 99999999

This parameter sets the minimum depth of cut in the multiple repetitive canned cycle G76.

5141	Finishing allowance in the multiple repetitive canned cycle G76

[Data type] 2-word

[Unit of data]

Increment system	IS-B	IS-C	Unit
Metric input	0.001	0.0001	mm
Inch input	0.0001	0.00001	inch

[Valid data range] 1 to 99999999

This parameter sets the finishing allowance in multiple repetitive canned cycle G76.

5142	Repetition count of final finishing in multiple repetitive canned cycle G76

[Data type] 2-word

[Unit of data] Cycle

[Valid data range] 1 to 99999999

This parameter sets the repetition count in multiple repetitive canned cycle G76.

5143	Tool nose angle in multiple repetitive canned cycle G76

[Data type] 2-word

[Unit of data] Degree

[Valid data range] When FS15 format is used: 0 to 120

When FS15 format is not used: 0, 29, 30, 55, 60, 80

This parameter sets the tool nose angle in multiple repetitive canned cycle G76.

4.26.4

Parameters of Peck Drilling Cycle of a Small Diameter

5160	#7	#6	#5	#4	#3	#2	#1	#0
						NOL	OLS	

[Data type] Bit

OLS When an overload torque signal is received in a peck drilling cycle of a small diameter, the feed and spindle speed are
 0 : Not changed.
 1 : Changed.

NOL When the depth of cut per action is satisfied although no overload torque signal is received in a peck drilling cycle of a small diameter, the feed and spindle speed are:
 0 : Not changed.
 1 : Changed.

5163	
	M code that specifies the peck drilling cycle mode of a small diameter

[Data type] 2-word

[Valid data range] 1 to 99999999

This parameter sets an M code that specifies the peck drilling cycle mode of a small diameter.

5164	
	Percentage of the spindle speed to be changed when the tool is retracted after an overload torque signal is received

[Data type] Byte

[Unit of data] %

[Valid data range] 1 to 255

This parameter sets the percentage of the spindle speed to be changed when the tool is retracted because the overload torque signal is received in a peck drilling cycle of a small diameter.

$$S2 = S1 \times d1 \div 100$$

S1: Spindle speed to be chaged

S2: Spindle speed changed

d1 is set as a percentage.

5165	
	Percentage of the spindle speed to be changed when the tool is retracted without an overload torque signal received

[Data type] Byte

[Unit of data] %

[Valid data range] 1 to 255

This parameter sets the percentage of the spindle speed to be changed when the tool is retracted without the overload torque signal received in a peck drilling cycle of a small diameter.

$$S2 = S1 \times d2 \div 100$$

S1: Spindle speed to be chaged

S2: Spindle speed changed

d2 is set as a percentage.

5166	
	Percentage of cutting feedrate to be changed when the tool is retracted after an overload torque signal is received

[Data type] Byte

[Unit of data] %

[Valid data range] 1 to 255

This parameter sets the percentage of the cutting feedrate to be changed when the tool is retracted because the overload torque signal is received in a peck drilling cycle of a small diameter.

$$F2 = F1 \times b1 \div 100$$

F1: Cutting feedrate to be changed

F2: Changed cutting feedrate

b1 is set as a percentage.

5167	
	Percentage of the cutting feedrate to be changed when the tool is retracted without an overload torque signal received

[Data type] Byte

[Unit of data] %

[Valid data range] 1 to 255

This parameter sets the percentage of the cutting feedrate to be changed when the tool is retracted without the overload torque signal received in a peck drilling cycle of a small diameter.

$$F2 = F1 \times b2 \div 100$$

F1: Cutting feedrate to be changed

F2: Changed cutting feedrate

b2 is set as a percentage.

5168	
	Lower limit of the percentage of the cutting feedrate in a peck drilling cycle of a small diameter

[Data type] Byte

[Unit of data] %

[Valid data range] 0 to 255

This parameter sets the lower limit of the percentage of the cutting feedrate changed repeatedly in a peck drilling cycle of a small diameter to the specified cutting feedrate.

$$FL = F \times b3 \div 100$$

F: Specified cutting feedrate

FL: Changed cutting feedrate

Set b3 as a percentage.

5170	
	Number of the macro variable to which the total number of retractions during cutting is output

[Data type] Word

[Valid data range] 100 to 149

This parameter sets the number of the macro variable to which the total number of times the tool is retracted during cutting in a peck drilling cycle mode of a small diameter is output.

NOTE

The total number cannot be output to common variables 500 to 531.

5171	
	Number of the macro variable to which the total number of retractions because of an overload signal is output

[Data type] Word

[Valid data range] 100 to 149

This parameter sets the common variable number of the custom macro to which the number of times the tool is retracted after the overload signal is received during cutting in a peck drilling cycle mode of a small diameter is output.

NOTE

The total number cannot be output to common variables 500 to 531.

5172	
	Speed of retraction to point R when no address I is issued

[Data type] Word

[Unit of data] mm/min

[Valid data range] 0 to 400

This parameter sets the speed of retraction to point R when no address I is issued in a peck drilling cycle of a small diameter.

5173	
	Speed of advancing to the position just before the bottom of a hole when no address I is issued

[Data type] Word

[Unit of data] mm/min

[Valid data range] 0 to 400

This parameter sets the speed of advancing to the position just before the bottom of a previously machined hole when no address I is issued in a peck drilling cycle of a small diameter.

5174	
	Clearance in a peck drilling cycle of a small diameter

[Data type] Word

[Unit of data]

Increment system	IS-A	IS-B	IS-C	Unit
Linear axis (millimeter input)	0.01	0.001	0.0001	mm
Linear axis (inch input)	0.001	0.0001	0.00001	inch

[Valid data range] 0 to 32767

This parameter sets the clearance in a peck drilling cycle of a small diameter.

4.27 PARAMETERS OF RIGID TAPPING

	#7	#6	#5	#4	#3	#2	#1	#0
5200	SRS	FHD		DOV	SIG	CRG	VGR	G84
		FHD	PCP	DOV	SIG	CRG	VGR	G84

[Data type] Bit

G84 Method for specifying rigid tapping

0 : An M code specifying the rigid tapping mode is specified prior to the issue of the G84 (or G74) command. (See parameter No.5210).

1 : An M code specifying the rigid tapping mode is not used. (G84 cannot be used as a G code for the tapping cycle; G74 cannot be used for the reverse tapping cycle.)

VGR Any gear ratio between spindle and position coder in rigid tapping

0 : Not used (The gear ratio is set in parameter No.3706.)

1 : Used (The gear ratio is set by parameters Nos. 5221 through 5224 and 5231 through 5234.)

NOTE

For serial spindles, set this parameter to 0 when using the DMR function for position coder signals on the spindle side.

CRG Rigid mode when a rigid mode cancel command is specified (G80, G01 group G code, reset, etc.)

0 : Canceled after rigid tapping signal RGTAP is set to "0".

1 : Canceled before rigid tapping signal RGTAP is set to "0".

SIG When gears are changed for rigid tapping, the use of SIND <G032 and G033> is

0 : Not permitted.

1 : Permitted.

DOV Override during extraction in rigid tapping

0 : Invalidated

1 : Validated (The override value is set in parameter No.5211.)

PCP Rigid tapping

0 : Used as a high-speed peck tapping cycle

1 : Not used as a high-speed peck tapping cycle

FHD Feed hold and single block in rigid tapping

0 : Invalidated

1 : Validated

SRS To select a spindle used for rigid tapping in multi-spindle control:

0 : The spindle selection signals SWS1 and SWS2 (bits 0 and 1 of G027) are used. (These signals are used also for multi-spindle control.)

1 : The rigid tapping spindle selection signals RGTSP1 and RGTSP2 (bits 4 and 5 of G061) are used. (These signals are provided expressly for rigid tapping.)

	#7	#6	#5	#4	#3	#2	#1	#0
5201				OV3	OVU	TDR		
				OV3	OVU	TDR		NIZ

[Data type] Bit

NIZ Smoothing in rigid tapping is:

0 : Not performed.

1 : Performed.

TDR Cutting time constant in rigid tapping

0 : Uses a same parameter during cutting and extraction (Parameter Nos. 5261 through 5264)

1 : Not use a same parameter during cutting and extraction

Parameter Nos. 5261 to 5264: Time constant during cutting

Parameter Nos. 5271 to 5274: Time constant during extraction

OVU The increment unit of the override parameter (No.5211) for tool rigid tapping extraction is:

0 : 1%

1 : 10%

OV3 The spindle speed for tool extraction is specified by program. Overriding based on this spindle speed is:

0 : Disabled.

1 : Enabled.

	#7	#6	#5	#4	#3	#2	#1	#0
5202								
								ORI

NOTE

When this parameter is set, the power must be turned off before operation is continued.

[Data type] Bit

ORI When rigid tapping is started:

0 : Spindle orientation is not performed.

1 : Spindle orientation is performed.

NOTE

This parameter can be used only for a serial spindle.

	#7	#6	#5	#4	#3	#2	#1	#0
5203				OVS	RGS	RFF		
			RBL	OVS		RFF	HRM	HRG

[Data type] Bit

HRG Rigid tapping by the manual handle is:

0 : Disabled.

1 : Enabled.

HRM When the tapping axis moves in the negative direction during rigid tapping controlled by the manual handle, the direction in which the spindle rotates is determined as follows:

- 0 : In G84 mode, the spindle rotates in a normal direction. In G74 mode, the spindle rotates in reverse.
- 1 : In G84 mode, the spindle rotates in reverse. In G74 mode, the spindle rotates in a normal direction.

REF Feed forward during movement from the initial point to point R in rigid tapping is:
 0 : Disabled.
 1 : Enabled.

When this parameter is set, the following function is also enabled:

- When rigid tapping is specified in look-ahead control mode, the system automatically exits from look-ahead control mode and executes rigid tapping. After termination of rigid tapping, the system automatically returns to look-ahead control mode.

RGS When bit 0 (MIF) of parameter No. 1403 is set to 1 and rigid tapping is specified in feed-per-minute mode, the spindle speed becomes:
 0 : 1/1000 of the specified speed.
 1 : 1/1 of the specified speed.

OVS In rigid tapping, override by the feedrate override signal and invalidation of override by the override cancel signal is:
 0 : Disabled.
 1 : Enabled.

Setting this parameter enables override by the feedrate override signal <G012> to be applied for rigid tapping operation (cutting and extraction) in rigid tapping.

The spindle speed override is fixed to 100%, but override is also applied to the spindle speed in synchronization with the feedrate along the tapping axis by feedrate override.

The override cancel signal OVC <bit 4 of G006> and second feedrate override signal <G013> also become available.

NOTE

- 1 When this parameter is set to override the feedrate, override by parameters (see parameters Nos. 5211 (T/M) and 5381 (M)) is disabled.
- 2 Regardless of whether this parameter is set, when feedrate override is disabled by the override cancel signal OVC <bit 4 of G006>, override by parameters (see parameters Nos. 5211 (T/M) and 5381 (M)) is enabled.
- 3 An option is required separately to use the second feedrate override signal <G013>.

RBL As acceleration/deceleration for rigid tapping cutting feed:
 0 : Linear acceleration/deceleration is used.
 1 : Bell-shaped acceleration/deceleration is used.

NOTE

The bell-shaped acceleration/deceleration option for rigid tapping is required.

	#7	#6	#5	#4	#3	#2	#1	#0
5204							SPR	DGN

NOTE

When this parameter is set, the power must be turned off before operation is continued.

[Data type] Bit

DGN On the diagnosis screen:

- 0 : A rigid tapping synchronization error is displayed. (Nos. 455 to 457)
- 1 : An error difference between the spindle and tapping axis is displayed. (Nos. 452 and 453)

SPR In rigid tapping, the parameters are:

- 0 : Not changed on a spindle-by-spindle basis.
- 1 : Changed on a spindle-by-spindle basis.

NOTE

1 When switching between the rigid tapping parameters on a spindle-by-spindle basis in rigid tapping using the second and third serial spindles, set this parameter to 1. The following parameters are supported for each spindle:

First spindle (4-stage gear)	Second spindle (2-stage gear)	Third spindle (2-stage gear)
No.5214	No.5215	No.5216
No.5221 to No.5224	No.5225, No.5226	No.5227, No.5228
No.5231 to No.5234	No.5235, No.5236	No.5237, No.5238
No.5241 to No.5244	No.5245, No.5246	No.5247, No.5248
No.5261 to No.5264	No.5265, No.5266	No.5267, No.5268
No.5271 to No.5274	No.5335, No.5336	No.5337, No.5338
No.5280	No.5341	No.5344
No.5281 to No.5284	No.5242, No.5243	No.5345, No.5346
No.5300, No.5301	No.5302, No.5303	No.5304, No.5305
No.5310 to No.5314	No.5350 to No.5353	No.5354 to No.5357
No.5321 to No.5324	No.5325, No.5326	No.5327, No.5328

2 For rigid tapping using the second and third serial spindles, the multispindle control option is required.

	#7	#6	#5	#4	#3	#2	#1	#0
5205								RCK
						NRV		RCK

[Data type] Bit

RCK In rigid tapping, an excessive error during movement/at stop is:

- 0 : Checked regardless of whether mode is cutting (tapping) or rapid traverse.
- 1 : Checked only in cutting (tapping) mode.

NRV For the rigid tapping function, the spindle returns back from the bottom of a hole with:

- 0 : Rotating opposite to the drilling direction
- 1 : Rotating in the drilling direction (special purpose)

NOTE

When you want to perform rigid tapping, do not set this parameter.

If rigid tapping is performed with this parameter set, a tapping tool, workpiece, or machine may be damaged.

5210

Rigid tapping mode specification M code

[Data type] Byte

[Valid data range] 0 to 255

This parameter sets an M code that specifies the rigid tapping mode. To set an M code larger than 255, set it to parameter No.5212.

NOTE

1 The M code is judged to be 29 (M29) when "0" is set.

2 To use an M code whose number is greater than 255, Specify the code number with parameter No.5212.

5211

Override value during rigid tapping extraction

[Data type] Byte

[Unit of data] 1 % or 10 %

[Valid data range] 0 to 200

The parameter sets the override value during rigid tapping extraction.

NOTE

The override value is valid when DOV in parameter No.5200 #4 is "1".

When OVU (bit 3 of parameter No.5201) is 1, the unit of set data is 10%. An override of up to 200% can be applied to extraction.

5212

M code that specifies a rigid tapping mode

[Data type] 2-word

[Unit of data] Integer

[Valid data range] 0 to 65535

This parameter sets the M code that specifies the rigid tapping mode.

The M code that specifies the rigid tapping mode is usually set by parameter 5210. To use an M code whose number is greater than 255, specify the code number with parameter 5212.

NOTE

If the setting of this parameter is 0, the M code specifying the rigid tapping mode is determined by the setting of parameter 5210. Otherwise, it is determined by the setting of parameter 5212. The setting of parameter 5212 must always be within the above valid range.

5213	
	Return or clearance in peck tapping cycle

[Data type] Word

[Unit of data]

Increment system	IS-A	IS-B	IS-C	Unit
Millimeter input	0.01	0.001	0.0001	mm
Input in include	0.001	0.0001	0.00001	inch

[Valid data range] 0 to 32767

This parameter sets the return or clearance in the peck tapping cycle.

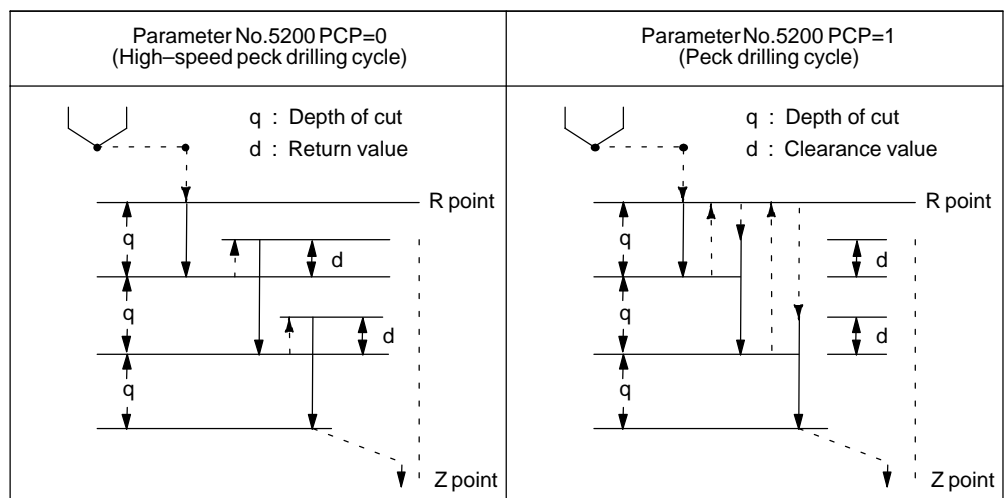

Fig.4.27 (a) High-speed Peck Drilling and Peck Drilling Cycles

5214	Setting of an allowable rigid tapping synchronization error range
5215	Setting of an allowable rigid tapping synchronization error range for the second spindle
5216	Setting of an allowable rigid tapping synchronization error range for the third spindle

[Data type] Word

[Unit of data] Detection unit

[Valid data range] 0 to 32767

Each of these parameters is used to set an allowable synchronization error range between a spindle used for rigid tapping and the tapping axis.

If the value set with each parameter is exceeded, rigid tapping alarm No.741 (excessive error during movement) is issued. When 0 is set, a synchronization error check is not made.

NOTE

When rigid tapping is performed using the second and third spindles

- When the SPR parameter (bit 1 of parameter No.5204) is set to 0, the setting of parameter No.5214 is applied to the second and third spindles, as well as to the first spindle.
- When the SPR parameter (bit 1 of parameter No.5204) is set to 1, the settings of parameter No.5215 and No.5216 are applied to the second and third spindles, respectively.

5221	Number of spindle gear teeth (first-stage gear)
5222	Number of spindle gear teeth (second-stage gear)
5223	Number of spindle gear teeth (third-stage gear)
5224	Number of spindle gear teeth (fourth-stage gear)
5225	Number of second spindle gear teeth (first-stage gear)
5226	Number of second spindle gear teeth (second-stage gear)
5227	Number of third spindle gear teeth (first-stage gear)
5228	Number of third spindle gear teeth (second-stage gear)

[Data type] Word

[Valid data range] 1 to 32767

When an arbitrary gear ratio is used in rigid tapping, each of these parameters sets the number of teeth of each spindle gear.

NOTE

- 1 These parameters are enabled when the VGR parameter (bit 1 of parameter No.5200) is set to 1.
- 2 When a position coder is attached to the spindle, set the same value for all of parameters No.5221 through No.5224.
- 3 When the DMR function of the position coder signal is used with a serial spindle, set the VGR parameter (bit 1 of parameter No.5200) to 0, and set these parameters to 0.
- 4 When rigid tapping is performed using the second and third spindles
 - When the SPR parameter (bit 1 of parameter No.5204) is set to 0, the settings of parameters No.5221 and No.5222 are applied to the second and third spindles, as well as to the first spindle.
 - When the SPR parameter (bit 1 of parameter No.5204) is set to 1, the settings of parameters No.5225 and No.5226 are applied to the second spindle, while the settings of parameters No.5227 and No.5228 are applied to the third spindle.

5231	Number of position coder gear teeth (first-stage gear)
5232	Number of position coder gear teeth (second-stage gear)
5233	Number of position coder gear teeth (third-stage gear)
5234	Number of position coder gear teeth (fourth-stage gear)
5235	Number of position coder gear teeth for the second spindle (first-stage gear)
5236	Number of position coder gear teeth for the second spindle (second-stage gear)
5237	Number of position coder gear teeth for the third spindle (first-stage gear)
5238	Number of position coder gear teeth for the third spindle (second-stage gear)

[Data type] Word

[Valid data range] 1 to 32767

When an arbitrary gear ratio is used in rigid tapping, each of these parameters sets the number of teeth of each position coder gear.

NOTE

- 1 These parameters are enabled when the VGR parameter (bit 1 of parameter No.5200) is set to 1.
When a position coder is attached to the spindle, set the same value for all of parameters No.5231 through No.5234. When a spindle motor with a built-in position coder is used, a position coder with a resolution of 2048 pulses/rev may be used. In such a case, set the actual number of teeth, multiplied by 2 (for conversion to 4096 pulses/rev).
- 2 When the DMR function of the position coder signal is used with a serial spindle, set the VGR parameter (bit 1 of parameter No.5200) to 0, and set these parameters to 0.
- 3 When rigid tapping is performed using the second and third spindles
 - When the SPR parameter (bit 1 of parameter No.5204) is set to 0, the settings of parameters No.5231 and No.5232 are applied to the second and third spindles, as well as to the first spindle.
 - When the SPR parameter (bit 1 of parameter No.5204) is set to 1, the settings of parameters No.5235 and No.5236 are applied to the second spindle, while the settings of parameters No.5237 and No.5238 are applied to the third spindle.

5241	Maximum spindle speed in rigid tapping (first-stage gear)
5242	Maximum spindle speed in rigid tapping (second-stage gear)
5243	Maximum spindle speed in rigid tapping (third-stage gear)
5244	Maximum spindle speed in rigid tapping (fourth-stage gear)
5245	Maximum spindle speed in rigid tapping using the second spindle (first-stage gear)
5246	Maximum spindle speed in rigid tapping using the second spindle (second-stage gear)
5247	Maximum spindle speed in rigid tapping using the third spindle (first-stage gear)
5248	Maximum spindle speed in rigid tapping using the third spindle (second-stage gear)

[Data type] 2-word

[Unit of data] min^{-1}

[Valid data range] Spindle position coder gear ratio

1:1 0 to 7400

1:2 0 to 9999

1:4 0 to 9999

1:8 0 to 9999

Each of these parameters is used to set a maximum spindle speed for each gear in rigid tapping.

NOTE

- 1 For the M series, set the same value for both parameter No.5241 and parameter No.5243 for a one-stage gear system. For a two-stage gear system, set the same value for parameter No.5242 and parameter No.5243. Otherwise, P/S alarm No.200 will be issued.
- 2 When rigid tapping is performed using the second and third spindles
 - When the SPR parameter (bit 1 of parameter No.5204) is set to 0, the settings of parameters No.5241 and No.5242 are applied to the second and third spindles, as well as to the first spindle.
 - When the SPR parameter (bit 1 of parameter No.5204) is set to 1, the settings of parameters No.5245 and No.5246 are applied to the second spindle, while the settings of parameters No.5247 and No.5248 are applied to the third spindle.

5261	Linear acceleration/deceleration time constant for the spindle and tapping axis (first-stage gear)
5262	Linear acceleration/deceleration time constant for the spindle and tapping axis (second-stage gear)
5263	Linear acceleration/deceleration time constant for the spindle and tapping axis (third-stage gear)
5264	Linear acceleration/deceleration time constant for the spindle and tapping axis (fourth-stage gear)
5265	Linear acceleration/deceleration time constant for the second spindle and tapping axis (first-stage gear)
5266	Linear acceleration/deceleration time constant for the second spindle and tapping axis (second-stage gear)
5267	Linear acceleration/deceleration time constant for the third spindle and tapping axis (first-stage gear)
5268	Linear acceleration/deceleration time constant for the third spindle and tapping axis (second-stage gear)

[Data type] Word

[Unit of data] ms

[Valid data range] 0 to 4000

Each of these parameters is used to set a linear acceleration/deceleration time constant for the spindle of each gear and the tapping axis in rigid tapping.

Set the period required to reach each maximum spindle speed (parameters No.5241 through No.5248). The set time constant, multiplied by the ratio of a specified S value to a maximum spindle speed, is actually used as a time constant.

NOTE

When rigid tapping is performed using the second and third spindles

- When the SPR parameter (bit 1 of parameter No.5204) is set to 0, the settings of parameters No.5261 and No.5262 are applied to the second and third spindles, as well as to the first spindle.
- When the SPR parameter (bit 1 of parameter No.5204) is set to 1, the settings of parameters No.5265 and No.5266 are applied to the second spindle, while the settings of parameters No.5267 and No.5268 are applied to the third spindle.

5271	Time constant for the spindle and tapping axis in extraction operation (first-stage gear)
5272	Time constant for the spindle and tapping axis in extraction operation (second-stage gear)
5273	Time constant for the spindle and tapping axis in extraction operation (third-stage gear)
5274	Time constant for the spindle and tapping axis in extraction operation (fourth-stage gear)

[Data type] Word

[Unit of data] ms

[Valid data range] 0 to 4000

Each of these parameters is used to set a linear acceleration/deceleration time constant for the spindle of each gear and tapping axis in extraction operation during rigid tapping.

NOTE

- 1 These parameters are enabled when the TDR parameter (bit 2 of parameter No.5201) is set to 1.
- 2 When rigid tapping is performed using the second and third spindles
 - When the SPR parameter (bit 1 of parameter No.5204) is set to 0, the settings of parameters No.5271 and No.5272 are applied to the second and third spindles, as well as to the first spindle.
 - When the SPR parameter (bit 1 of parameter No.5204) is set to 1, the settings of parameters No.5335 and No.5336 are applied to the second spindle, while the settings of parameters No.5337 and No.5338 are applied to the third spindle.

5280	Position control loop gain for the spindle and tapping axis in rigid tapping (common to all gears)
5281	Position control loop gain for the spindle and tapping axis in rigid tapping (first-stage gear)
5282	Position control loop gain for the spindle and tapping axis in rigid tapping (second-stage gear)
5283	Position control loop gain for the spindle and tapping axis in rigid tapping (third-stage gear)
5284	Position control loop gain for the spindle and tapping axis in rigid tapping (fourth-stage gear)

NOTE

Once these parameters have been set, the power must be turned off then back on for the settings to become effective.

[Data type] Word

[Unit of data] 0.01 s^{-1}

[Valid data range] 1 to 9999

Each of these parameters is used to set a position control loop gain for the spindle and tapping axis in rigid tapping. These parameters significantly affect the precision of threading. Optimize these parameters as well as the loop gain multipliers by conducting a cutting test.

NOTE

- 1 To use a varied loop gain on a gear-by-gear basis, set parameter No.5280 to 0, and set a loop gain for each gear in parameters No.5281 through No.5284. The specification of a loop gain on a gear-by-gear basis is disabled if parameter No.5280 is set to a value other than 0. In such a case, the value set in parameter No.5280 is used as a loop gain that is common to all the gears.
- 2 When rigid tapping is performed using the second and third spindles
 - When the SPR parameter (bit 1 of parameter No.5204) is set to 0, the setting of parameter No.5280 or the settings of parameters No.5281 and No.5282 are applied to the second and third spindles, as well as to the first spindle.
 - When the SPR parameter (bit 1 of parameter No.5204) is set to 1, the settings of parameters No.5341 through No.5343 are applied to the second spindle, while the settings of parameters No.5344 through No.5346 are applied to the third spindle.

5291	Spindle loop gain multiplier in the rigid tapping mode (for gear 1)
5292	Spindle loop gain multiplier in the rigid tapping mode (for gear 2)
5293	Spindle loop gain multiplier in the rigid tapping mode (for gear 3)
5294	Spindle loop gain multiplier in the rigid tapping mode (for gear 4)

[Data type] Word type

[Valid data range] 0 to 32767

Set the spindle loop gain multipliers for gears 1 to 4 in the rigid tapping mode. The thread precision depends on the multipliers. Find the most appropriate multipliers by conducting the cutting test and assign them to the parameters.

NOTE

These parameters are used for analog spindles.

Loop gain multiplier = $2048 \times E/L \times \alpha \times 1000$

where;

E : Voltage in the velocity command at 1000 min⁻¹

L : Rotation angle of the spindle per one rotation of the spindle motor

α : Unit used for the detection

Examples

1 : 1 : 2

When the spindle motor, spindle, and position coder are connected as shown left, let the variables be as follows:

E = 1.667 (V) (A motor speed of 6000 min⁻¹ corresponds to 10 V.)
 L = 360° (One rotation of the spindle corresponds to one rotation of the spindle motor.)

$\alpha = La/4096$
 = 720°/4096
 = 0.17578

La = 720° (= 360° × 2. One rotation of the position coder corresponds to two rotations of the spindle.)
 4096 = The number of detected pulses per rotation of the position coder

Gear ratio between the spindle and the position coder

1:1	0.08789 degrees
1:2	0.17578 degrees
1:4	0.35156 degrees
1:8	0.70313 degrees

According to above ratio the loop gain multiplier is calculated as
 $2048 \times 1.667/360 \times 0.17578 \times 1000 = 1667$

* When the position coder which is built in a spindle motor sends 512 pulses per rotation, the unit used for the detection, α , is La/2048.

Fig.4.27 (b) Connection among the spindle motor, spindle, and position coder

5300	Tapping axis in-position width in rigid tapping
5301	Spindle in-position width in rigid tapping

[Data type] Word

[Unit of data] Detection unit

[Valid data range] 0 to 32767

These parameters are used to set tapping axis and spindle in-position widths in rigid tapping.

NOTE

- 1 If an excessively large value is specified, the threading precision will deteriorate.
- 2 When rigid tapping is performed using the second and third spindles
 - When the SPR parameter (bit 1 of parameter No.5204) is set to 0, the settings of parameter No.5300 and No.5301 are applied to the second and third spindles, as well as to the first spindle.
 - When the SPR parameter (bit 1 of parameter No.5204) is set to 1, the settings of parameters No.5302 and No.5303 are applied to the second spindle, while the settings of parameters No.5304 and No.5305 are applied to the third spindle.

5302	Tapping axis in-position width in rigid tapping using the second spindle
5303	Spindle in-position width in rigid tapping using the second spindle

[Data type] Word

[Unit of data] Detection unit

[Valid data range] 0 to 32767

These parameters are used to set spindle and tapping axis in-position widths in rigid tapping using the second spindle.

NOTE

These parameters are enabled when the SPR parameter (bit 1 of parameter No.5204) is set to 1.

5304	Tapping axis in-position width in rigid tapping using the third spindle
5305	Spindle in-position width in rigid tapping using the third spindle

[Data type] Word

[Unit of data] Detection unit

[Valid data range] 0 to 32767

These parameters are used to set spindle and tapping axis in-position widths in rigid tapping using the third spindle.

NOTE

These parameters are enabled when the SPR parameter (bit 1 of parameter No.5204) is set to 1.

5308

In-position width at point R in rigid tapping (tapping axis)

[Data type] Word

[Unit of data] Detection unit

[Valid data range] 0 to 32767

This parameter is used to set the tapping axis in-position width at point R in rigid tapping.

5310

Positional deviation limit imposed during tapping axis movement in rigid tapping

[Data type] Word

[Unit of data] Detection unit

[Valid data range] 1 to 32767

This parameter is used to set a positional deviation limit during tapping axis movement in rigid tapping. A value that falls outside the valid data range, described above, can be specified in parameter No.5314.

NOTE

- 1 When a high-resolution detector is used, the unit must be multiplied by 10.
- 2 When rigid tapping is performed using the second and third spindles
 - When the SPR parameter (bit 1 of parameter No.5204) is set to 0, the setting of parameter No.5310 (or No.5314) is applied to the second and third spindles, as well as to the first spindle.
 - When the SPR parameter (bit 1 of parameter No.5204) is set to 1, the settings of parameters No.5350 and No.5354 are applied to the second spindle and third spindle, respectively.

5311

Limit value of spindle positioning deviation during movement in rigid tapping.

[Data type] Word type

[Unit of data] Detection unit

[Valid data range] 1 to 32767

This parameter sets the limit value of a spindle positioning deviation during movement in rigid tapping.

$$\text{Limit value} = S \times 360 \times 100 \times 1.5 / (60 \times G \times \alpha)$$

where

- S : Maximum spindle speed in rigid tapping
(Setting value of parameter Nos. 5241 and greater)
- G : Loop gain of rigid tapping axis
(Setting value of parameter Nos. 5280 and greater)
- α : Detection unit

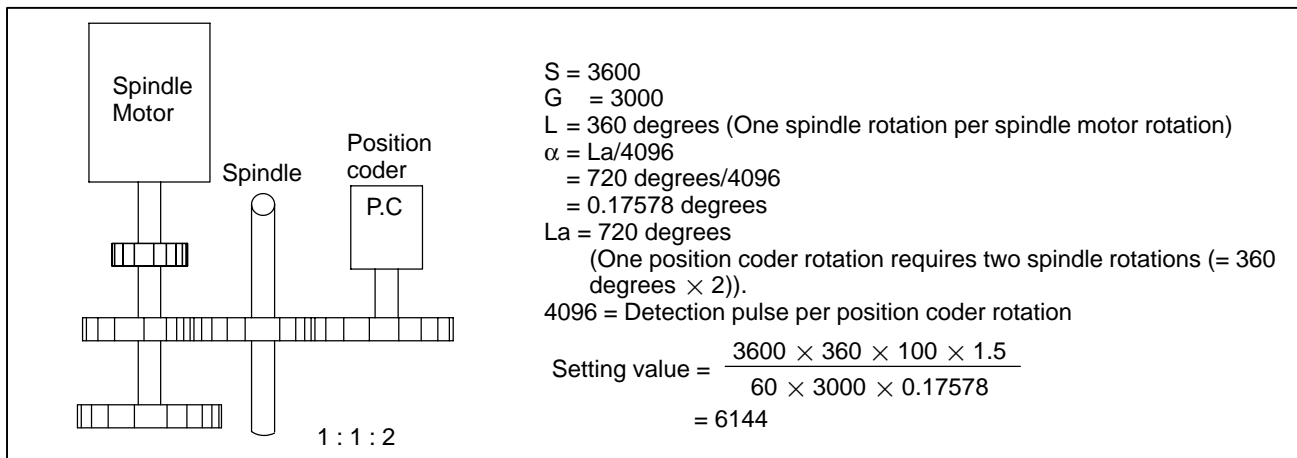
(Calculation example)**Fig.4.27 (c) Connection Among Spindle Motor, Spindle and Position Coder****NOTE**

- 1 The detection unit is $\alpha = La/2048$ when the position coder built-in spindle motor uses a position coder of 512 pulses per revolution.
- 2 When rigid tapping is performed using the second and third spindles
 - When the SPR parameter (bit 1 of parameter No.5204) is set to 0, the setting of parameter No.5311 is applied to the second and third spindles, as well as to the first spindle.
 - When the SPR parameter (bit 1 of parameter No.5204) is set to 1, the settings of parameters No.5351 and No.5355 are applied to the second spindle and third spindle, respectively.

5312

Positional deviation limit imposed while the tapping axis is stopped in rigid tapping

[Data type] Word**[Unit of data]** Detection unit**[Valid data range]** 1 to 32767

This parameter is used to set a positional deviation limit imposed while the tapping axis is stopped in rigid tapping.

NOTE

- When rigid tapping is performed using the second and third spindles
- When the SPR parameter (bit 1 of parameter No.5204) is set to 0, the setting of parameter No.5312 is applied to the second and third spindles, as well as to the first spindle.
 - When the SPR parameter (bit 1 of parameter No.5204) is set to 1, the settings of parameters No.5352 and No.5356 are applied to the second spindle and third spindle, respectively.

5313

Positional deviation limit imposed while the spindle is stopped in rigid tapping

[Data type] Word**[Unit of data]** Detection unit**[Valid data range]** 1 to 32767

This parameter is used to set a positional deviation limit imposed while the spindle is stopped in rigid tapping.

NOTE

When rigid tapping is performed using the second and third spindles

- When the SPR parameter (bit 1 of parameter No.5204) is set to 0, the setting of parameter No.5313 is applied to the second and third spindles, as well as to the first spindle.
- When the SPR parameter (bit 1 of parameter No.5204) is set to 1, the settings of parameters No.5353 and No.5357 are applied to the second spindle and third spindle, respectively.

5314

Positional deviation limit imposed during tapping axis movement in rigid tapping

[Data type] 2-word**[Unit of data]** Detection unit**[Valid data range]** 0 to 99999999

Usually, parameter No.5310 is used to set a positional deviation limit imposed during tapping axis movement in rigid tapping. However, parameter No.5314 can be used to set a value greater than the valid data range of parameter No.5310 because of the resolution of the detector being used.

NOTE

1 When parameter No.5314 is set to 0, the setting of parameter No.5310 is used. When parameter No.5314 is set to a value other than 0, parameter No.5310 is disabled; in this case, the setting of parameter No.5314 is used.

2 When rigid tapping is performed using the second and third spindles

- When the SPR parameter (bit 1 of parameter No.5204) is set to 0, the setting of parameter No.5314 (or No.5310) is applied to the second and third spindles, as well as to the first spindle.
- When the SPR parameter (bit 1 of parameter No.5204) is set to 1, the settings of parameters No.5350 and No.5354 are applied to the second spindle and third spindle, respectively.

5321	Spindle backlash in rigid tapping (first-stage gear)
	Spindle backlash in rigid tapping
5322	Spindle backlash in rigid tapping (second-stage gear)
5323	Spindle backlash in rigid tapping (third-stage gear)
5324	Spindle backlash in rigid tapping (fourth-stage gear)
5325	Spindle backlash in rigid tapping using the second spindle (first-stage gear)
	Spindle backlash in rigid tapping using the second spindle
5326	Spindle backlash in rigid tapping using the second spindle (second-stage gear)
5327	Spindle backlash in rigid tapping using the third spindle (first-stage gear)
	Spindle backlash in rigid tapping using the third spindle
5328	Spindle backlash in rigid tapping using the third spindle (second-stage gear)

[Data type] Byte

[Unit of data] Detection unit

[Valid data range] 0 to 127

Each of these parameters is used to set a spindle backlash.

NOTE

When rigid tapping is performed using the second and third spindles

- When the SPR parameter (bit 1 of parameter No.5204) is set to 1, the settings of parameters No.5325 and No.5326 are applied to the second spindle, while the settings of parameters No.5227 and No.5228 are applied to the third spindle.
- When the SPR parameter (bit 1 of parameter No.5204) is set to 0, the settings of parameters No.5321 and No.5322 are applied to the second spindle and third spindle, as well as to the first spindle.

5335	Time constant for the spindle and tapping axis in second spindle extraction operation (first-stage gear)
5336	Time constant for the spindle and tapping axis in second spindle extraction operation (second-stage gear)
5337	Time constant for the spindle and tapping axis in third spindle extraction operation (first-stage gear)
5338	Time constant for the spindle and tapping axis in third spindle extraction operation (second-stage gear)

[Data type] Word

[Unit of data] ms

[Valid data range] 0 to 4000

Each of these parameters is used to set a linear acceleration/deceleration time constant for the spindle and tapping axis in extraction operation during rigid tapping on a gear-by-gear basis.

NOTE

This parameter is enabled when both the TDR parameter (bit 2 of parameter No.5201) and the SPR parameter (bit 1 of parameter No.5204) are set to 1.

5341	Position control loop gain for the spindle and tapping axis in rigid tapping using the second spindle (common to all the gears)
5342	Position control loop gain for the spindle and tapping axis in rigid tapping using the second spindle (first-stage gear)
5343	Position control loop gain for the spindle and tapping axis in rigid tapping using the second spindle (second-stage gear)

NOTE

After these parameters have been set, the power must be turned off then back on for the settings to become effective.

[Data type] Word

[Unit of data] 0.01 s^{-1}

[Valid data range] 1 to 9999

Each of these parameters is used to set a position control loop gain for the spindle and tapping axis in rigid tapping using the second spindle.

NOTE

- 1 To use a varied loop gain on a gear-by-gear basis, set parameter No.5341 to 0, and set a loop gain for each gear in parameters No.5342 and No.5343.
- 2 This parameter is enabled when the SPR parameter (bit 1 of parameter No.5204) is set to 1.

5344	Position control loop gain for the spindle and tapping axis in rigid tapping using the third spindle (common to all the gears)
5345	Position control loop gain for the spindle and tapping axis in rigid tapping using the third spindle (first-stage gear)
5346	Position control loop gain for the spindle and tapping axis in rigid tapping using the third spindle (second-stage gear)

NOTE

After these parameters have been set, the power must be turned off then back on for the settings to become effective.

[Data type] Word

[Unit of data] 0.01 s^{-1}

[Valid data range] 1 to 9999

Each of these parameters is used to set a position control loop gain for the spindle and tapping axis in rigid tapping using the third spindle.

NOTE

1 To use a varied loop gain on a gear-by-gear basis, set parameter No.5344 to 0, and set a loop gain for each gear in parameters No.5345 and No.5346.

2 This parameter is enabled when the SPR parameter (bit 1 of parameter No.5204) is set to 1.

5350	Positional deviation limit imposed during tapping axis movement in rigid tapping using the second spindle
------	---

[Data type] 2-word

[Unit of data] Detection unit

[Valid data range] 1 to 99999999

This parameter sets a positional deviation limit imposed during tapping axis movement in rigid tapping using the second spindle.

NOTE

This parameter is enabled when the SPR parameter (bit 1 of parameter No.5204) is set to 1.

5351	Positional deviation limit imposed during spindle movement in rigid tapping using the second spindle
------	--

[Data type] Word

[Unit of data] Detection unit

[Valid data range] 1 to 32767

This parameter is used to set a positional deviation limit imposed during spindle movement in rigid tapping using the second spindle.

NOTE

This parameter is enabled when the SPR parameter (bit 1 of parameter No.5204) is set to 1.

5352

Positional deviation limit imposed while the tapping axis is stopped in rigid tapping using the second spindle

[Data type] Word**[Unit of data]** Detection unit**[Valid data range]** 1 to 32767

This parameter is used to set a positional deviation limit imposed while the tapping axis is stopped in rigid tapping using the second spindle.

NOTE

This parameter is enabled when the SPR parameter (bit 1 of parameter No.5204) is set to 1.

5353

Positional deviation limit imposed while the spindle is stopped in rigid tapping using the second spindle

[Data type] Word**[Unit of data]** Detection unit**[Valid data range]** 1 to 32767

This parameter is used to set a positional deviation limit imposed while the spindle is stopped in rigid tapping using the second spindle.

NOTE

This parameter is enabled when the SPR parameter (bit 1 of parameter No.5204) is set to 1.

5354

Positional deviation limit imposed during tapping axis movement in rigid tapping using the third spindle

[Data type] 2-word**[Unit of data]** Detection unit**[Valid data range]** 1 to 99999999

This parameter is used to set a positional deviation limit imposed during tapping axis movement in rigid tapping using the third spindle.

NOTE

This parameter is enabled when the SPR parameter (bit 1 of parameter No.5204) is set to 1.

5355

Positional deviation limit imposed during spindle movement in rigid tapping using the third spindle

[Data type] Word**[Unit of data]** Detection unit**[Valid data range]** 1 to 32767

This parameter is used to set a positional deviation limit imposed during spindle movement in rigid tapping using the third spindle.

NOTE

This parameter is enabled when the SPR parameter (bit 1 of parameter No.5204) is set to 1.

5356

Positional deviation limit imposed while the tapping axis is stopped in rigid tapping using the third spindle

[Data type] Word**[Unit of data]** Detection unit**[Valid data range]** 1 to 32767

This parameter is used to set a positional deviation limit imposed while the tapping axis is stopped in rigid tapping using the third spindle.

NOTE

This parameter is enabled when the SPR parameter (bit 1 of parameter No.5204) is set to 1.

5357

Positional deviation limit imposed while the spindle is stopped in rigid tapping using the third spindle

[Data type] Word**[Unit of data]** Detection unit**[Valid data range]** 1 to 32767

This parameter is used to set a positional deviation limit imposed while the spindle is stopped in rigid tapping using the third spindle.

NOTE

This parameter is enabled when the SPR parameter (bit 1 of parameter No.5204) is set to 1.

5365	
	Bell-shaped acceleration/deceleration time constant for the first spindle in rigid tapping (first-stage gear)
5366	
	Bell-shaped acceleration/deceleration time constant for the first spindle in rigid tapping (second-stage gear)
5367	
	Bell-shaped acceleration/deceleration time constant for the first spindle in rigid tapping (third-stage gear)

[Data type] Word

[Unit of data] msec

[Valid data range] 0 to 512

These parameters are used to set bell-shaped acceleration/deceleration time constants for the first spindle in rigid tapping.

5369	
	Bell-shaped acceleration/deceleration time constant for the second spindle in rigid tapping (first-stage gear)
5370	
	Bell-shaped acceleration/deceleration time constant for the second spindle in rigid tapping (second-stage gear)

[Data type] Word

[Unit of data] msec

[Valid data range] 0 to 512

These parameters are used to set bell-shaped acceleration/deceleration time constants for the second spindle in rigid tapping.

5373	
	Bell-shaped acceleration/deceleration time constant for the third spindle in rigid tapping (first-stage gear)
5374	
	Bell-shaped acceleration/deceleration time constant for the third spindle in rigid tapping (second-stage gear)

[Data type] Word

[Unit of data] msec

[Valid data range] 0 to 512

These parameters are used to set bell-shaped acceleration/deceleration time constants for the third spindle in rigid tapping.

5377	
	Bell-shaped acceleration/deceleration time constant for the fourth spindle in rigid tapping (first-stage gear)

5378	
	Bell-shaped acceleration/deceleration time constant for the fourth spindle in rigid tapping (second-stage gear)

[Data type] Word

[Unit of data] msec

[Valid data range] 0 to 512

These parameters are used to set bell-shaped acceleration/deceleration time constants for the fourth spindle in rigid tapping.

NOTE

These parameters are valid only for the Series 16i.

5381	
	Override value during rigid tapping return

[Data type] Byte

[Unit of data] 1%

[Valid data range] 0 to 200

This parameter is used to set the override value during rigid tapping return.

If the setting is 0, no override is applied.

NOTE

This parameter is valid when bit 4 (DOV) of parameter No. 5200 is set to 1.

5382	
	Amount of return for rigid tapping return

[Data type] 2-word

[Unit of data] Input increments

[Valid data range] 0 to 99999999

During rigid tapping return, the tool can be pulled out, along the tapping axis, going beyond the stored rigid tapping start position by the amount specified with this parameter.

If the tool has already been retracted from rigid tapping, it will be retracted further only by the distance specified in this parameter.

4.28 PARAMETERS OF SCALING/ COORDINATE ROTATION

	#7	#6	#5	#4	#3	#2	#1	#0
5400				RCW	D3C	D3R		RIN
	SCR	XSC		RCW	D3C	D3R		RIN

[Data type] Bit

- RIN** Coordinate rotation angle command (R)
0 : Specified by an absolute method
1 : Specified by G90 or G91
- D3R** The three-dimensional coordinate conversion mode can be cancelled by:
0 : The G69 (M series) command, the G69.1 (T series) command, a reset operation, or a CNC reset by signal input from the PMC.
1 : The G69 (M series) command or G69.1 (T series) command only.
- D3C** In a hole machining canned cycle during three-dimensional coordinate conversion, rapid traverse operation is performed in:
0 : Rapid traverse mode
1 : Cutting mode
- RCW** When a workpiece or local coordinate system command is issued in coordinate system rotation mode:
0 : No alarm is issued.
1 : An alarm (P/S alarm No. 5302) is issued.
- XSC** Axis scaling and programmable mirror image
0 : Invalidated (The scaling magnification is specified by P.)
1 : Validated
- SCR** Scaling magnification unit
0 : 0.00001 times (1/100,000)
1 : 0.001 times

	#7	#6	#5	#4	#3	#2	#1	#0
5401								
								SCLx

[Data type] Bit axis

- SCLx** Scaling
0 : Invalidated
1 : Validated

5410	Angular displacement used when no angular displacement is specified for coordinate system rotation
------	--

[Data type] 2-word

[Unit of data] 0.001 degrees

[Valid data range] -360000 to 360000

This parameter sets the angular displacement for coordinate system rotation. When the angular displacement for coordinate system rotation is not specified with address R in the block where G68 is specified, the setting of this parameter is used as the angular displacement for coordinate system rotation.

5411	
	Magnification used when scaling magnification is not specified

Setting entry is acceptable.

[Data type] 2-word

[Unit of data] 0.001 or 0.00001 times (Selected using SCR, #7 of parameter No.5400)

[Valid data range] 1 to 999999

This parameter sets the scaling magnification. This setting value is used when a scaling magnification (P) is not specified in the program.

NOTE

Parameter No.5421 becomes valid when scaling for every axis is valid. (XSC, #6 of parameter No.5400 is "1".)

5412	Rapid traverse rate for a hole machining cycle in three-dimensional coordinate conversion mode
------	--

[Data type] 2-word

[Units of data], [Valid data range]

Increment system	Units of data	Valid data range	
		IS-A, IS-B	IS-C
Millimeter machine	1 mm/min	30 to 240000	6 to 100000
Inch machine	0.1 inch/min	30 to 96000	6 to 48000
Rotation axis	1 deg/min	30 to 240000	6 to 100000

5421	
	Scaling magnification for every axis

Setting entry is acceptable.

[Data type] 2-word axis

[Unit of data] 0.001 or 0.00001 times (Selected using SCR, #7 of parameter No.5400)

[Valid data range] -999999 to -1, 1 to 999999

This parameter sets the scaling magnification for every axis.

4.29 PARAMETERS OF UNI-DIRECTIONAL POSITIONING

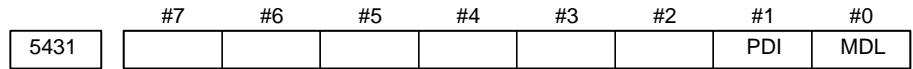

[Data type] Bit

MDL Specifies whether the G code for single direction positioning (G60) is included in one-shot G codes (00 group) or modal G codes (01 group)

- 0: One-shot G codes (00 group)
- 1: Modal G codes (01 group)

PDI When the tool is stopped before or after a specified end point with the unidirectional positioning function:

- 0 : No in-position check is performed.
- 1 : An in-position check is performed.

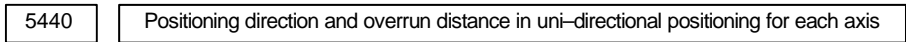
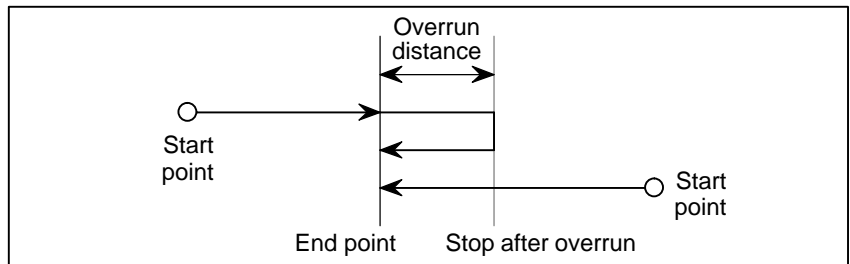

[Data type] Word axis

[Unit of data]

Increment system	IS-A	IS-B	IS-C	Unit
Millimeter machine	0.01	0.001	0.0001	mm
Inch machine	0.001	0.0001	0.00001	inch
Rotation axis	0.01	0.001	0.0001	deg

[Valid data range] -16383 to +16383

This parameter sets the positioning direction and overrun distance in uni-directional positioning (G60) for each axis. The positioning direction is specified using a setting data sign, and the overrun distance using a value set here.

- Overrun distance > 0: The positioning direction is positive (+).**
- Overrun distance < 0: The positioning direction is negative (-).**
- Overrun distance = 0: Uni-directional positioning is not performed.**

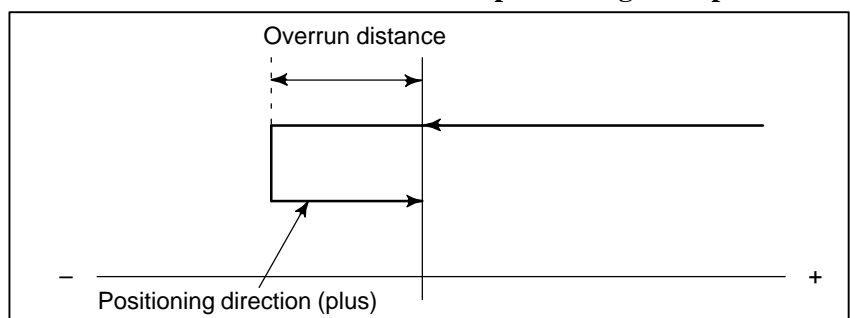

Fig.4.29 Positioning Direction and Overrun distance

4.30 PARAMETERS OF POLAR COORDINATE INTERPOLATION

	#7	#6	#5	#4	#3	#2	#1	#0
5450							AFC	
						PLS		

[Data type] Bit

- AFC** In polar coordinate interpolation mode, automatic override operation and automatic feedrate clamp operation are:
 0 : Not performed.
 1 : Performed.

NOTE

In polar coordinate interpolation mode, the feedrate component for a rotational axis increases as the tool moves closer to the center of a workpiece. Near the center of a workpiece, the maximum cutting feedrate (parameter No.5462) may be exceeded, causing servo alarm No.411 to be issued. The automatic feedrate override function and automatic feedrate clamp function automatically control the feedrate to prevent the feedrate component on a rotation axis from exceeding a specified maximum cutting feedrate.

- PLS** The polar coordinate interpolation shift function is:
 0 : Not used.
 1 : Used.

Conventionally, the origin of the workpiece coordinate system in polar coordinate interpolation was always fixed to the center of the rotation axis. By this parameter setting, the workpiece coordinate system can also be shifted in polar coordinate interpolation. This enables machining using the workpiece coordinate system with a desired point which is not the center of the rotation axis set as the origin of the coordinate system in polar coordinate interpolation.

In polar coordinate interpolation mode, specify coordinates X-C (or Y-A or Z-B) in the workpiece coordinate system with the origin set to the center of rotation axis C (or A or B) set on each polar coordinate interpolation plane in the following format:

- G12.1 X__ C__ ; (Polar coordinate interpolation with the X-axis and C-axis)
 G12.1 Y__ A__ ; (Polar coordinate interpolation with the Y-axis and A-axis)
 G12.1 Z__ B__ ; (Polar coordinate interpolation with the Z-axis and B-axis)

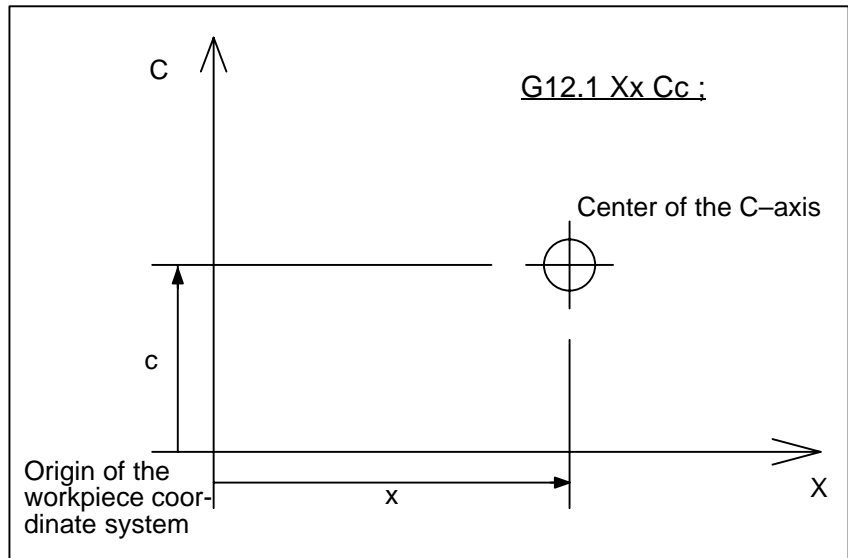

(Example for polar coordinate interpolation with the X-axis and C-axis)

NOTE

Carefully issue a command to shift the polar coordinate interpolation coordinate system with this parameter disabled because the command is recognized as a move command and the machine operates.

5460	Axis (linear axis) specification for polar coordinate interpolation
5461	Axis (rotary axis) specification for polar coordinate interpolation

[Data type] Byte

[Valid data range] 1, 2, 3, ... control axes count

These parameters set control axis numbers of linear and rotary axes to execute polar interpolation.

5462	Maximum cutting feedrate during polar coordinate interpolation
------	--

[Data type] 2-word

[Unit of data]

[Valid data range]

Increment system	Unit of data	Valid data range	
		IS-A, IS-B	IS-C
Millimeter machine	1 mm/min	0, 6 to 240000	0, 6 to 100000
Inch machine	0.1 inch/min	0, 6 to 96000	0, 6 to 48000
Rotation axis	1 deg/min	0, 6 to 240000	0, 6 to 100000

This parameter sets the upper limit of the cutting feedrate that is effective during polar coordinate interpolation. If a feedrate greater than the maximum feedrate is specified during polar coordinate interpolation, it is clamped to the feedrate specified by the parameter. When the setting is 0, the feedrate during polar coordinate interpolation is clamped to the maximum cutting feedrate usually specified with parameter 1422.

5463

Allowable automatic override percentage in polar coordinate interpolation

[Data type] Byte**[Unit of data]** %**[Valid data range]** 0 to 100

This parameter sets an allowable percentage to find an allowable feedrate on a rotation axis in polar coordinate interpolation mode. A maximum cutting feedrate (parameter No.5462), multiplied by the allowable percentage set with this parameter represents an allowable feedrate.

(Allowable feedrate on rotation axis) = (maximum cutting feedrate) × (allowable percentage)

In polar coordinate interpolation mode, the feedrate component on a rotation axis increases as the tool moves closer to the center of a workpiece. Near the center of a workpiece, the maximum allowable feedrate (parameter No.5462) may be exceeded. To prevent the feedrate component on a rotation axis from exceeding the maximum allowable feedrate in polar coordinate interpolation mode, the following override is automatically applied to the feedrate (automatic override):

$$\text{(Override)} = \frac{\text{(Allowable feedrate on rotation axis)}}{\text{(Feedrate component on rotation axis)}} \times 100 (\%)$$

If the overridden feedrate component for a rotation axis still exceeds the allowable feedrate, the feedrate is clamped to prevent the feedrate component on a rotation axis from exceeding a maximum cutting feedrate (automatic feedrate clamp).

NOTE

When 0 is set in this parameter, a specification of 90% is assumed. When a value of 100 or greater is set with this parameter, a specification of 100% is assumed. Before the automatic override function and automatic feedrate clamp function can be used, bit 1 (AFC) of parameter No.5450 must be set to 1.

4.31 PARAMETERS OF NORMAL DIRECTION CONTROL

5480	
	Number of the axis for controlling the normal direction

[Data type] Byte

[Valid data range] 1 to the maximum control axis number

This parameter sets the control axis number of the axis for controlling the normal direction.

5481	
	Rotation feedrate of normal direction control axis

[Data type] Word

[Unit of data] deg/min

[Valid data range] 1 to 15000

This parameter sets the feedrate of a normal direction control axis that is inserted at the start point of a block during normal direction control.

5482	
	Limit value that ignores the rotation insertion of normal direction control axis

[Data type] 2-word

[Unit of data]

Increment system	IS-A	IS-B	IS-C	Unit
Rotation axis	0.01	0.001	0.0001	deg

[Valid data range] 1 to 99999999

The rotation block of a normal direction control axis is not inserted when the rotation insertion angle calculated during normal direction control does not exceed this setting value. The ignored rotation angle is added to the next rotation insertion angle. The block insertion is then judged.

NOTE

- 1 No rotation block is inserted when 360 or more degrees are set.
- 2 If 180 or more degrees are set, a rotation block is inserted only when the circular interpolation is 180 or more degrees.

5483	
	Limit value of movement that is executed at the normal direction angle of a preceding block

[Data type] 2-word

[Unit of data]

Increment system	IS-A	IS-B	IS-C	Unit
Millimeter input	0.01	0.001	0.0001	mm
Inch input	0.001	0.0001	0.00001	inch

[Valid data range] 1 to 99999999

This parameter sets the limit value of movement at the normal direction angle of a preceding block.

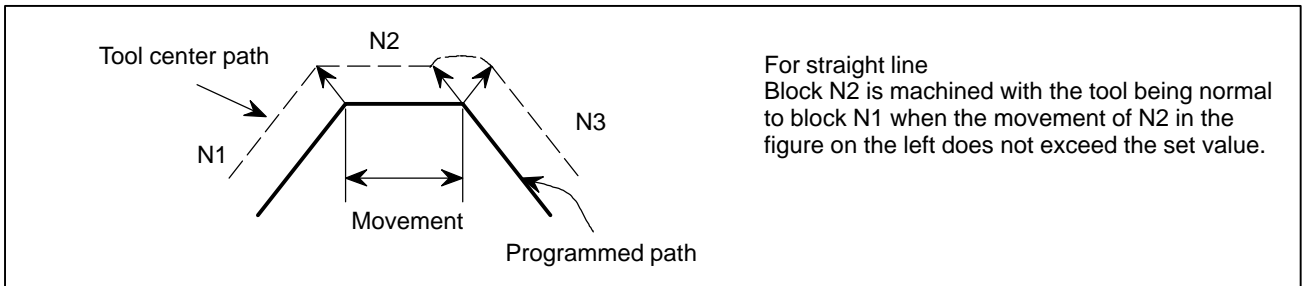

Fig.4.31 (a) When the Block Moves Along a Straight Line

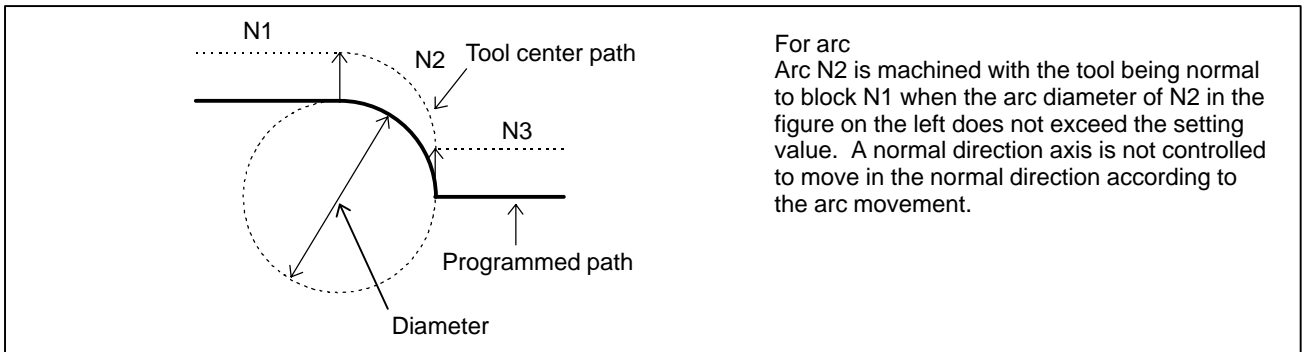

Fig.4.31 (b) When the Block Moves Along on Arc

	#7	#6	#5	#4	#3	#2	#1	#0
5484								
						ANM		SDC

[Data type] Bit

SDC In normal direction control:

- 0 : A C-axis movement is automatically inserted between blocks so that the C-axis is directed at right angles to the direction of motion at the start point of each block. (After movement on the C-axis, movement (along the X-axis and Y-axis) specified by the block is performed.)
- 1 : If the amount of C-axis movement is smaller than the value set in parameter No.5485, a C-axis movement is not inserted before a block. Instead, it is performed together with movement along the X-axis and Y-axis.

ANM In AI contour control mode, the normal direction control function is:

- 0 : Disabled.
- 1 : Enabled.

5485	
	Limit imposed on the insertion of a single block for rotation about the normal direction control axis

[Data type] 2-word

[Unit of data]

Increment system	IS-A	IS-B	IS-C	Units
Rotation axis	0.01	0.001	0.0001	deg

[Valid data range] 1 to 99999999

When normal direction control is applied, the amount of movement (rotation angle) on the normal direction control axis (C-axis), calculated so that the C-axis is directed at right angles to the direction of motion at the start point of a block, may be smaller than the value specified in this parameter. In such a case, the C-axis movement is not inserted before the movement (along the X-axis and Y-axis) specified by the block. Instead, the C-axis movement is performed together with the movement specified by the block. If the amount of movement (rotation angle) on the C-axis is greater than or equal to the value specified with this parameter, the C-axis movement is inserted, and the movement specified by the block is made after the completion of the C-axis movement.

NOTE

This parameter is enabled when the SDC parameter (bit 0 of parameter No.5484) is set to 1. If a value equal to or greater than 180 degrees is specified, a C-axis movement is inserted only when circular interpolation involving a C-axis rotation of 180 degrees or more is performed.

4.32 PARAMETERS OF INDEXING INDEX TABLE

	#7	#6	#5	#4	#3	#2	#1	#0
5500								
	IDX	SIM		G90	INC	ABS	REL	DDP

[Data type] Bit type

- DDP** Selection of decimal-point input method of index table indexing axis
 0 : Conventional method (Example IS-B: B1; = 0.001 deg)
 1 : Pocket calculator method (Example IS-B: B1; = 1.000 deg)
- REL** Relative position display of index table indexing axis
 0 : Not rounded by 360 degrees
 1 : Rounded by 360 degrees
- ABS** Displaying absolute coordinate value of index table indexing axis
 0 : Not rounded by 360 degrees
 The index table indexing axis rotates 720 degrees (two rotations) when G90 B720.0; is specified from the 0-degree position. It rotates in reverse direction 720 degrees (two rotations) when G90 B0.; is specified. The absolute coordinate value then becomes 0 degree.
 1 : Rounded by 360 degrees
 The index table indexing axis is positioned in 40 degrees when G90 B400.0; is specified from the 0-degree position. The index table indexing axis does not rotate by two or more turns when this parameter is set to 1. It also does not move when G90 B720.0; is specified from the 0-degree position.
- INC** Rotation in the G90 mode when negative-direction rotation command M code (parameter No.5511) is not set
 0 : Not set to the shorter way around the circumference
 1 : Set to the shorter way around the circumference (Set ABS, #2 of parameter No.5500, to 1.)
- G90** Index table indexing command
 0 : Judged to be an absolute/increment command according to the G90/G91 mode
 1 : Judged to be an absolute command
- SIM** When the same block includes a command for an index table indexing axis and a command for another controlled axis:
 0 : A P/S alarm (No.136) is issued.
 1 : The commands are executed. (In a block other than G00, G28, and G30, however, a P/S alarm (No.136) is issued.)
- IDX** Index table indexing sequence
 0 : Type A
 1 : Type B

5511	
	Negative-direction rotation command M code

[Data type] Byte

[Valid data range] 0 to 255

0 : Not use an M code that sets the index table rotation to the negative direction. The rotation direction is specified using a command and parameter (INC, #3 of parameter No.5500).

1 to 255:

Sets an M code that sets the index table rotation to the negative direction. The rotation is set to the negative direction only when an M code set here is specified in the same block as an index table indexing command. If the M code is not specified in the same block, the rotation is always set to the positive direction.

NOTE

Set ABS, #2 of parameter No.5500, to 1.

5512	
	Unit of index table indexing angle

[Data type] 2-word

[Unit of data]

Input increment	IS-A	IS-B	IS-C	Unit
Rotation axis	0.01	0.001	0.0001	deg

[Valid data range] 0 to 360000

This parameter sets the unit of index table indexing angle. A P/S alarm (No.135) generated when movement other than integer multiple of the setting value is specified.

NOTE

If zero is specified as the setting value, any command can be specified irrespective of the unit of angle.

4.33 PARAMETERS OF INVOLUTE INTERPOLATION

5610	Limit of initial permissible error during involute interpolation

[Data type] 2-word

[Unit of data]

Increment system	IS-A	IS-B	IS-C	Unit
Metric input	0.01	0.001	0.0001	mm
Inch input	0.001	0.0001	0.00001	inch

[Valid data range] 0 to 99999999

This parameter sets the allowable limit of deviation between an involute curve passing through a start point and an involute curve passing through an end point for an involute interpolation command.

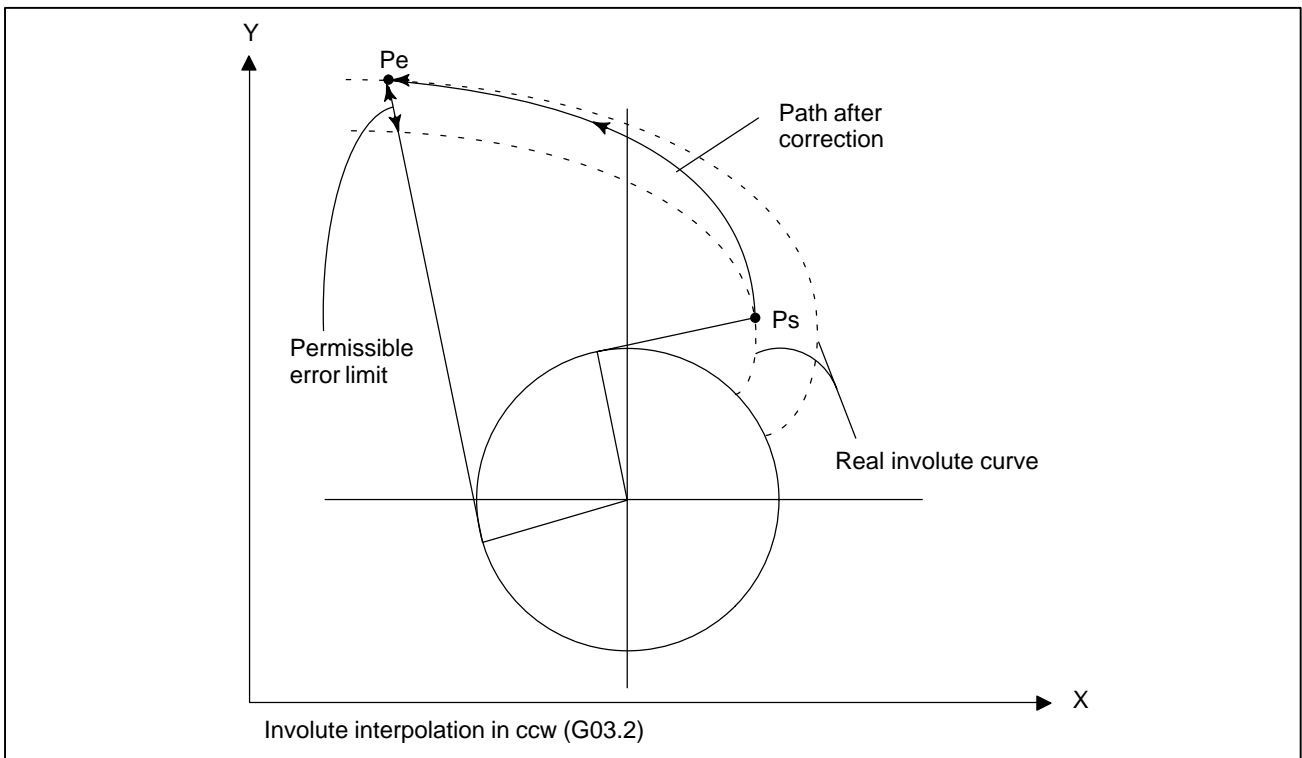

5611	Radius of curvature at cutting point for starting basic circle neighborhood override 1
5612	Radius of curvature at cutting point for starting basic circle neighborhood override 2
5613	Radius of curvature at cutting point for starting basic circle neighborhood override 3
5614	Radius of curvature at cutting point for starting basic circle neighborhood override 4
5615	Radius of curvature at cutting point for starting basic circle neighborhood override 5

[Data type] 2-word

[Unit of data]

Increment system	IS-B	IS-C	Units
Metric input	0.001	0.0001	mm
Inch input	0.0001	0.00001	inch

[Valid data range] 1 to 99999999

The settings of these parameters are used for automatic speed control during involute interpolation.

5616	Override value for starting basic circle neighborhood override 2
5617	Override value for starting basic circle neighborhood override 3
5618	Override value for starting basic circle neighborhood override 4
5619	Override value for starting basic circle neighborhood override 5

[Data type] Byte

[Unit of data] %

[Valid data range] 1 to 100

The settings of these parameters are used for automatic speed control during involute interpolation.

5620	Lower override limit during involute interpolation
------	--

[Data type] Byte

[Unit of data] %

[Valid data range] 1 to 100

The setting of this parameter is used for automatic speed control during involute interpolation.

5621	
	Lower override limit during involute interpolation

[Data type] Word

[Unit of data] ms

[Valid data range] 1 to 32767

This parameter is used to set the maximum acceleration speed while constant acceleration control is applied during involute interpolation in high-precision contour control mode.

Set the time required until the speed set in parameter No. 8400 for setting the acceleration for linear acceleration/deceleration before interpolation is reached.

5622	
	Minimum speed while constant acceleration control is applied during involute interpolation

[Data type] Word

[Unit of data]

Increment system	IS-A	IS-B	IS-C	Unit
Metric machine	100.0	10.0	1.0	mm/min
Inch machine	10.0	1.0	0.1	inch/min
Rotation axis	100.0	10.0	1.0	deg/min

[Valid data range] 1 to 32767

This parameter is used to set the minimum deceleration speed during deceleration according to the maximum acceleration speed (parameter No. 5621) while constant acceleration control is applied during involute interpolation in high-precision contour control mode.

NOTE

When parameter No. 5621 or 5622 is set to 0, constant acceleration control is not applied during involute interpolation in high-precision contour control mode.

4.34 PARAMETERS OF EXPONENTIAL INTERPOLATION

5630	#7	#6	#5	#4	#3	#2	#1	#0
								SPN

[Data type] Bit

SPN The amount of linear axis division (span value) in exponential interpolation is:

0 : Specified with parameter No.5643.

1 : Specified using address K in a block containing G02.3/G03.3. When address K is not specified, the value set with parameter No.5643 is used.

5641	
	Linear axis number subject to exponential interpolation

[Data type] Byte

[Valid data range] 1 to number of controlled axes

This parameter sets the ordinal number, among the controlled axes, for the linear axis to which exponential interpolation is applied.

5642	
	Rotation axis number subject exponential interpolation

[Data type] Byte

[Valid data range] 1 to number of controlled axes

This parameter sets the ordinal number, among the controlled axes, for the rotation axis to which exponential interpolation is applied.

5643	
	Amount of linear axis division (span value) in exponential interpolation

[Data type] 2-word

[Valid data range]

Increment system	IS-A	IS-B	IS-C	Unit
Millimeter input	0.01	0.001	0.0001	mm
Inch input	0.001	0.0001	0.00001	inch

[Valid data range] 1 to 99999999

This parameter sets the amount of linear axis division in exponential interpolation when bit 0 (SPN) of parameter No.5630 is set to 0.

4.35 PARAMETERS OF FLEXIBLE SYNCHRONIZATION

5660	Master axis number (group A)
5661	Slave axis number (group A)
5662	Master axis number (group B)
5663	Slave axis number (group B)
5664	Master axis number (group C)
5665	Slave axis number (group C)
5666	Master axis number (group D)
5667	Slave axis number (group D)

[Data type] Byte

[Valid data range] 1 to Number of controlled axis

These parameters sets the master and slave axes in flexible synchronization control.

NOTE

A master axis number must be smaller than the axis number of the corresponding slave axis.

5670	M code number for turning flexible synchronization mode on (group A)
5671	M code number for turning flexible synchronization mode off (group A)
5672	M code number for turning flexible synchronization mode on (group B)
5673	M code number for turning flexible synchronization mode off (group B)
5674	M code number for turning flexible synchronization mode on (group C)
5675	M code number for turning flexible synchronization mode off (group C)
5676	M code number for turning flexible synchronization mode on (group D)
5677	M code number for turning flexible synchronization mode off (group D)

[Data type] Word

[Valid data range] 0 to 999

These parameters set M code numbers for turning flexible synchronization control mode on and off during automatic operation.

5680	Numerator for determining the gear ratio for flexible synchronization (group A)
5681	Denominator for determining the gear ratio for flexible synchronization (group A)
5682	Numerator for determining the gear ratio for flexible synchronization (group B)
5683	Denominator for determining the gear ratio for flexible synchronization (group B)
5684	Numerator for determining the gear ratio for flexible synchronization (group C)
5685	Denominator for determining the gear ratio for flexible synchronization (group C)
5686	Numerator for determining the gear ratio for flexible synchronization (group D)
5687	Denominator for determining the gear ratio for flexible synchronization (group D)

[Data type] 2-word

[Valid data range] -99999999 to 99999999

These parameters set the gear ratio of each pair of master and slave axes.

5690	Exponent for the denominator of the gear ratio for flexible synchronization (group A)
5691	Exponent for the denominator of the gear ratio for flexible synchronization (group B)
5692	Exponent for the denominator of the gear ratio for flexible synchronization (group C)
5693	Exponent for the denominator of the gear ratio for flexible synchronization (group D)

[Data type] Byte

[Valid data range] 0 to 8

These parameters set the exponent for the denominator for determining the gear ratio of each pair of master and slave axes.

The gear ratio is calculated as follows:

$$\frac{q}{p \times 10^k}$$

where,

p: Denominator for determining the gear ratio for flexible synchronization

q: Numerator for determining the gear ratio for flexible synchronization

k: Exponent for the denominator of the gear ratio for flexible synchronization

4.36 PARAMETERS OF STRAIGHTNESS COMPENSATION

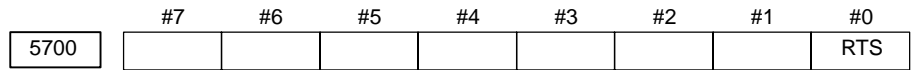

NOTE
When this parameter has been set, the power must be turned off before operation is continued.

[Data type] Bit

RTS When compensation is rewritten for the straightness compensation function, it is enabled:
0 : After power-off.
1 : Immediately.

When this function is enabled, no power-off alarm is issued even if a compensation parameter for straightness compensation (No. 5761 to 5784) is rewritten.

5711	Axis number of moving axis 1
5712	Axis number of moving axis 2
5713	Axis number of moving axis 3

[Data type] Byte

[Unit of data] Axis number (When 0, compensation is not performed.)

[Valid data range] 1 to Number of controlled axes.
Set the axis numbers of moving axes.

5721	Axis number of compensation axis 1 for moving axis 1
5722	Axis number of compensation axis 2 for moving axis 2
5723	Axis number of compensation axis 3 for moving axis 3

[Data type] Byte

[Unit of data] Axis number (When 0, compensation is not performed.)

[Valid data range] 1 to Number of controlled axes.
Set the axis numbers of compensation axes.

5731	Compensation point number a of moving axis 1
5732	Compensation point number b of moving axis 1
5733	Compensation point number c of moving axis 1
5734	Compensation point number d of moving axis 1
5741	Compensation point number a of moving axis 2
5742	Compensation point number b of moving axis 2
5743	Compensation point number c of moving axis 2
5744	Compensation point number d of moving axis 2
5751	Compensation point number a of moving axis 3
5752	Compensation point number b of moving axis 3
5753	Compensation point number c of moving axis 3
5754	Compensation point number d of moving axis 3

[Data type] Word

[Unit of data] Number

(Compensation point numbers in stored pitch error compensation)

[Valid data range] 0 to 1023

Set four compensation point for each moving axis.

5761	Compensation corresponding compensation point number a of moving axis 1
5762	Compensation corresponding compensation point number b of moving axis 1
5763	Compensation corresponding compensation point number c of moving axis 1
5764	Compensation corresponding compensation point number d of moving axis 1
5771	Compensation corresponding compensation point number a of moving axis 2
5772	Compensation corresponding compensation point number b of moving axis 2
5773	Compensation corresponding compensation point number c of moving axis 2
5774	Compensation corresponding compensation point number d of moving axis 2
5781	Compensation corresponding compensation point number a of moving axis 3
5782	Compensation corresponding compensation point number b of moving axis 3
5783	Compensation corresponding compensation point number c of moving axis 3
5784	Compensation corresponding compensation point number d of moving axis 3

[Data type] Word

[Unit of data] Detection unit

[Valid data range] -32768 to +32767

NOTE

Set compensation for each compensation point.

4.37**PARAMETERS OF
GRADIENT
COMPENSATION**

5861	Compensation point number a for each axis
5862	Compensation point number b for each axis
5863	Compensation point number c for each axis
5864	Compensation point number d for each axis

NOTE

When this parameter has been set, the power must be turned off before operation is continued.

[Data type] Word axis

[Unit of data] Number

[Valid data range] 0 to 1023

These parameters set the compensation points for gradient compensation. The points are set for the compensation point numbers for stored pitch error compensation.

NOTE

Set compensation point numbers such that $a < b < c < d$ is satisfied.

5871	Compensation α at compensation point number a for each axis
5872	Compensation β at compensation point number b for each axis
5873	Compensation γ at compensation point number c for each axis
5874	Compensation ϵ at compensation point number d for each axis

[Data type] Word axis

[Unit of data] Detection unit

[Valid data range] -32767 to 32767

These parameters set compensation for each compensation point.

If pitch error compensation is applied at the same compensation point, the valid data range is narrowed by the amount of compensation.

4.38 PARAMETERS OF CUSTOM MACROS

	#7	#6	#5	#4	#3	#2	#1	#0
6000	SBV		SBM	HGO			MGO	G67
	SBV		SBM	HGO	V15		MGO	G67

[Data type] Bit

G67 If the macro continuous-state call cancel command (G67) is specified when the macro continuous-state call mode (G66) is not set:

0 : P/S alarm No.122 is issued.

1 : The specification of G67 is ignored.

MGO When a GOTO statement for specifying custom macro control is executed, a high-speed branch to 20 sequence numbers executed from the start of the program is:

0 : A high-speed branch is not caused to n sequence numbers from the start of the executed program.

1 : A high-speed branch is caused to n sequence numbers from the start of the program.

V15 As system variable numbers for tool offset:

0 : The standard system variable numbers for the Series 16 are used.

1 : The same system variable numbers as those used for the Series 15 are used.

The tables below indicate the system variables for tool offset numbers 1 to 999. The values for tool offset numbers 1 to 200 can be read from or assigned to the system variables in parentheses.

(1) Tool offset memory A

	System parameter number	
	V15 = 0	V15 = 1
Wear offset value	#10001 to #10999 (#2001 to #2200)	#10001 to #10999 (#2001 to #2200)

(2) Tool offset memory B

	System parameter number	
	V15 = 0	V15 = 1
Geometry offset value	#11001 to #11999 (#2201 to #2400)	#10001 to #10999 (#2001 to #2200)
Wear offset value	#10001 to #10999 (#2001 to #2200)	#11001 to #11999 (#2201 to #2400)

(3) Tool offset memory C

		System parameter number	
		V15 = 0	V15 = 1
H-Code	Geometry offset value	#11001 to #11999 (#2201 to #2400)	#10001 to #10999 (#2001 to #2200)
	Wear offset value	#10001 to #10999 (#2001 to #2200)	#11001 to #11999 (#2201 to #2400)
D-Code	Geometry offset value	#13001 to #13999	#12001 to #12999
	Wear offset value	#12001 to #12999	#13001 to #13999

- HGO** When a GOTO statement for specifying custom macro control is executed:
- 0 : A high-speed branch is not caused to 30 sequence numbers, immediately following the point of execution.
 - 1 : A high-speed branch is caused to 30 sequence numbers, immediately before the point of execution.

- SBM** Custom macro statement
- 0: Not stop the single block
 - 1: Stops the single block

If you want to disable the single blocks in custom macro statements using system variable #3003, set this parameter to 0. If this parameter is set to 1, the single blocks in custom macro statements cannot be disabled using system variable #3003. To control single blocks in custom macro statements using system variable #3003, use bit 7 (SBV) of parameter No. 6000.

NOTE

This bit is invalid when bit 0 (NOP) of parameter No. 6000 is set to 1.

- SBV** Custom macro statement
- 0 : Not stop the single block
 - 1 : Stops the single block

To control single blocks in custom macro statements using system variable #3003, use this parameter to enable or disable single blocks in custom macro statements.

This bit is valid when bit 5 (SBM) of parameter No. 6000 is set to 0.

	#7	#6	#5	#4	#3	#2	#1	#0
6001	CLV	CCV	TCS	CRO	PV5		PRT	

[Data type] Bit

- PRT** Reading zero when data is output using a DPRINT command
- 0 : Outputs a space
 - 1 : Outputs no data
- PV5** Custom macro common variables:
- 0 : Nos. 500 to 599 are output.
 - 1 : Nos. 100 to 199 and Nos. 500 to 599 are output.
- CRO** ISO code in BPRWT or DPRNT command
- 0 : Outputs only LF after data is output
 - 1 : Outputs LF and CR after data is output
- TCS** Subprogram
- 0 : Not called using a T code
 - 1 : Called using a T code
- CCV** Custom macro's common variables Nos. 100 through 149 (to 199)
- 0: Cleared to "vacant" by reset
 - 1: Not cleared by reset
- CLV** Custom macro's local variables Nos. 1 through 33
- 0: Cleared to "vacant" by reset
 - 1: Not cleared by reset

	#7	#6	#5	#4	#3	#2	#1	#0
6003	MUS	MCY	MSB	MPR	TSE	MIN	MSK	

NOTE

When this parameter is set, the power must be turned off before operation is continued.

[Data type] Bit

- MSK** Absolute coordinates at that time during custom macro interrupt
 0 : Not set to the skip coordinates (system variables #5061 and later)
 1 : Set to the skip coordinates (system variables #5061 and later)
- MIN** Custom macro interrupt
 0 : Performed by interrupting an in-execution block (Custom macro interrupt type I)
 1 : Performed after an in-execution block is completed (Custom macro interrupt type II)
- TSE** Custom macro interrupt signal UINT
 0 : Edge trigger method (Rising edge)
 1 : Status trigger method
- MPR** Custom macro interrupt valid/invalid M code
 0 : M96/M97
 1 : M code set using parameters (Nos. 6033 and 6034)
- MSB** Interrupt program
 0 : Uses a dedicated local variable (Macro-type interrupt)
 1 : Uses the same local variable as in the main program (Subprogram-type interrupt)
- MCY** Custom macro interrupt
 0 : Not performed during cycle operation
 1 : Performed during cycle operation
- MUS** Interrupt-type custom macro
 0 : Not used
 1 : Used

	#7	#6	#5	#4	#3	#2	#1	#0
6004						VHD	MFZ	NAT
			D15				MFZ	NAT

[Data type] Bit

- NAT** Specification of the results of custom macro functions ATAN
 0 : The result of ATAN is 0 to 360.0.
 1 : The result of ATAN is -180 to 0 to 180.0.
- MFZ** If the angle of a custom macro operation command SIN, COS, or TAN is $1.0 \times 10^{*-8}$ or below or if the result of operation is not accurately 0, the operation result is:
 0: Handled as underflow.
 1: Normalized to 0.

VHD With system variables #5121 through #5128
 0 : Tool position offset values (geometry offset values) are read.
 1 : The amount of interrupt shift caused by a manual handle interrupt is read.

D15 When tool compensation memory C is used, for reading or writing tool offset values (for up to offset number 200) for D code (tool radius), the same system variables, #2401 through #2800, as Series 15 are:
 0 : Not used.
 1 : Used.

D code		
Offset number	Geometry offset value	Tool wear compensation value
1	#2401	#2601
2	#2402	#2602
⋮	⋮	⋮
200	#2600	#2800

NOTE

When the D15 parameter is set to 1, system variables #2500 through #2806, for workpiece reference point offset values, cannot be used. Instead, use system variables #5201 through #5324.

	#7	#6	#5	#4	#3	#2	#1	#0
6005								SQC
							ADR	SQC

NOTE

When this parameter has been set, the power must be turned off before operation is continued.

[Data type] Bit

SQC Calling a subprogram with its sequence number by the subprogram call function is:
 0 : Disabled.
 1 : Enabled.

ADR Calling a subprogram with address E by the subprogram call function using a custom macro and macro executor special code is:
 0 : Disabled.
 1 : Enabled.

Address E can be set for parameters Nos. 6090 and 6091.

	#7	#6	#5	#4	#3	#2	#1	#0
6006								MLG

[Data type] Bit

MLG In conditional decision statements in custom macros, logical operations:
 0 : Cannot be used.
 1 : Can be used.

	#7	#6	#5	#4	#3	#2	#1	#0
6010	*7	*6	*5	*4	*3	*2	*1	*0
6011	=7	=6	=5	=4	=3	=2	=1	=0
6012	#7	#6	#5	#4	#3	#2	#1	#0
6013	[7	[6	[5	[4	[3	[2	[1	[0
6014]7]6]5]4]3]2]1]0

[Data type] Bit

These parameters are used to input/output macro statements.

The numeral of a suffix indicates the bit position in a code.

*0 to *7 : Set the hole pattern of an EIA code indicating *.

=0 to =7 : Set the hole pattern of an EIA code indicating =.

#0 to #7 : Set the hole pattern of an EIA code indicating #.

[0 to [7 : Set the hole pattern of an EIA code indicating [.

] 0 to] 7 : Set the hole pattern of an EIA code indicating].

0 : Corresponding bit is 0

1 : Corresponding bit is 1.

6030	M code that calls the program entered in file
------	---

[Data type] Byte

[Valid data range] 0, and 1 to 255

This parameter sets an M code that calls the program entered in a file.

NOTE

The M code is judged to be M198 when zero is specified as the setting value.

6033	M code that validates a custom macro interrupt
------	--

6034	M code that invalidates a custom macro interrupt
------	--

[Data type] Byte

[Valid data range] 0 to 255

These parameters set the custom macro interrupt valid/invalid M codes.

NOTE

These parameters can be used when MPR, #4 of parameter No.6003, is 1. M96 is used as a valid M code and M97 is used as an invalid M code when MPR is 0, irrespective of the state of this parameter.

6036

Number of custom macro variables common to tool path (#100's)

[Data type] Word**[Unit of data]** Number of custom macro variables**[Valid data range]** 0 to 100

The parameter specifies the number of variables commonly used for both tool paths 1 and 2 (custom macro variables common to tool paths) that are included in custom macro variables 100 to 149 (199).

The custom macro variables common to tool paths can be written from or read into either of the tool paths.

Examples

When this parameter is set to 10, the custom macro variables are specified as follows:

Custom macro variables 100 to 109: Used commonly between two paths

Custom macro variables 110 to 149 (199): Used independently for each path

NOTE

1 This parameter is dedicated to the 2-path control.

2 When this parameter is set to 0, custom macro variables 100 to 149 (199) are not used commonly between two paths.

6037

Number of custom macro variables common to tool path after (#500's)

[Data type] Word**[Unit of data]** Number of custom macro variables**[Valid data range]** 0 to 500

The parameter specifies the number of variables commonly used for both tool paths 1 and 2 (custom macro variables common to tool paths) that are included in custom macro variables 100 to 531 (999).

The custom macro variables common to tool paths can be written from or read into either of the tool paths.

Examples

When this parameter is set to 10, the custom macro variables are specified as follows:

Custom macro variables 500 to 509: Used commonly between two paths

Custom macro variables 510 to 531 (999): Used independently for each path

NOTE

1 This parameter is dedicated to the 2-path control.

2 When this parameter is set to 0, custom macro variables 500 to 531 (999) are not used commonly between two paths.

6050	G code that calls the custom macro of program number 9010
6051	G code that calls the custom macro of program number 9011
6052	G code that calls the custom macro of program number 9012
6053	G code that calls the custom macro of program number 9013
6054	G code that calls the custom macro of program number 9014
6055	G code that calls the custom macro of program number 9015
6056	G code that calls the custom macro of program number 9016
6057	G code that calls the custom macro of program number 9017
6058	G code that calls the custom macro of program number 9018
6059	G code that calls the custom macro of program number 9019

[Data type] Word

[Valid data range] 1 to 999

These parameters set the G codes that call the custom macros of program numbers 9010 through 9019.

NOTE

Setting value 0 is invalid. No custom macro can be called by G00.

6071	M code that calls the subprogram of program number 9001
6072	M code that calls the subprogram of program number 9002
6073	M code that calls the subprogram of program number 9003
6074	M code that calls the subprogram of program number 9004
6075	M code that calls the subprogram of program number 9005
6076	M code that calls the subprogram of program number 9006
6077	M code that calls the subprogram of program number 9007
6078	M code that calls the subprogram of program number 9008
6079	M code that calls the subprogram of program number 9009

[Data type] 2-word

[Valid data range] 1 to 99999999

These parameters set the M codes that call the subprograms of program numbers 9001 through 9009.

NOTE

Setting value 0 is invalid. No subprogram can be called by M00.

6080	M code that calls the custom macro of program number 9020
6081	M code that calls the custom macro of program number 9021
6082	M code that calls the custom macro of program number 9022
6083	M code that calls the custom macro of program number 9023
6084	M code that calls the custom macro of program number 9024
6085	M code that calls the custom macro of program number 9025
6086	M code that calls the custom macro of program number 9026
6087	M code that calls the custom macro of program number 9027
6088	M code that calls the custom macro of program number 9028
6089	M code that calls the custom macro of program number 9029

[Data type] 2–word

[Valid data range] 1 to 99999999

These parameters set the M codes that call the custom macros of program numbers 9020 through 9029.

NOTE

Setting value 0 is invalid. No custom macro can be called by M00.

6090	ASCII code that calls the subprogram of program number 9004
6091	ASCII code that calls the subprogram of program number 9005

NOTE

When this parameter is set, the power must be turned off before operation is continued.

[Data type] Byte

[Valid data range] 65 (A:41H) to 90 (Z:5AH)

These parameters set the ASCII codes that call subprograms in decimal.

Addresses that can be used are as follows:

T series : A, B, F, H, I, K, M, P, Q, R, S, T

M series: A, B, D, F, H, I, J, K, L, M, P, Q, R, S, T, X, Y, Z

NOTE

Set 0 when no subprogram is called

4.39 PARAMETERS OF SIMPLE MACROS

6095

Number of programs used for simple macro calls

[Data type] Byte**[Unit of data]** Number of programs**[Valid data range]** 0 to 16

This parameter specifies the number of programs used for simple macro calls. If this parameter is set to 0, this function is disabled.

6096

Number of the first program used for simple macro calls

[Data type] Word**[Unit of data]** Number**[Valid data range]** 1 to 9999

This parameter specifies the number of the first program used for simple macro calls.

6097

Start address of signals used for simple macro calls

[Data type] Word**[Unit of data]** Number**[Valid data range]** 0 to 65535

This parameter specifies the start address of signals used for simple macro calls. If a nonexistent number is set, this function is disabled.

4.40 PARAMETERS OF PATTERN DATA INPUT

6101	First variable number displayed on pattern data screen 1
6102	First variable number displayed on pattern data screen 2
6103	First variable number displayed on pattern data screen 3
6104	First variable number displayed on pattern data screen 4
6105	First variable number displayed on pattern data screen 5
6106	First variable number displayed on pattern data screen 6
6107	First variable number displayed on pattern data screen 7
6108	First variable number displayed on pattern data screen 8
6109	First variable number displayed on pattern data screen 9
6110	First variable number displayed on pattern data screen 10

[Data type] Word

[Valid data range] 0, 100 to 199, 500 to 999

These parameters specify the first variable number displayed on the pattern data screen selected from the pattern menu screen. When 0 is set, 500 is assumed.

4.41 PARAMETERS OF POSITIONING BY OPTIMUM ACCELERATION

	#7	#6	#5	#4	#3	#2	#1	#0
6131							EOA	OAD

NOTE

When this parameter is set, the power must be turned off before operation is continued.

[Data type] Bit axis

OAD The function for positioning by optimum acceleration (when rapid traverse is specified in automatic operation, the function adjusts the rapid traverse rate, time constant, and loop gain to one of seven levels, according to the amount of travel for the block) is:

0 : Not used.

1 : Used.

EOA For a movement along the PMC axis, the function for positioning by optimum acceleration is:

0 : Disabled.

1 : Enabled.

Bit 0 (OAD) of parameter No. 6131 must also be set to 1.

	#7	#6	#5	#4	#3	#2	#1	#0
6132								ILP

[Data type] Bit

ILP For the function for positioning by optimum acceleration, loop gain switching is:

0 : Performed.

1 : Not performed.

6136	Distance D1 to the first stage of positioning by optimum acceleration for each axis
------	---

6137	Distance D2 to the second stage of positioning by optimum acceleration for each axis
------	--

6138	Distance D3 to the third stage of positioning by optimum acceleration for each axis
------	---

[Data type] 2-word axis

[Unit of data]

Increment system	IS-A	IS-B	IS-C	Unit
Metric machine	0.01	0.001	0.0001	mm
Inch machine	0.01	0.001	0.0001	inch
Rotation axis	0.01	0.001	0.0001	deg

[Valid data range] 0 to 99999999

These parameters set the distances to the first to third stages of positioning by optimum acceleration for each axis.

Set the positioning distances used when the function for 4-stage switching of the rapid traverse rate, time constant, and loop gain based on positioning distance is used.

6141	Distance D1 for level 1 (metric input)
6142	Distance D2 for level 2 (metric input)
6143	Distance D3 for level 3 (metric input)
6144	Distance D4 for level 4 (metric input)
6145	Distance D5 for level 5 (metric input)
6146	Distance D6 for level 6 (metric input)

[Data type] 2–word

[Unit of data]

Increment system	IS–A	IS–B	IS–C	Units
Linear axis (inch input)	0.01	0.001	0.0001	mm
Rotation axis	0.01	0.001	0.0001	deg

[Valid data range] 0 to 99999999

These parameters set the positioning distances used when the function for adjusting the rapid traverse rate, time constant, and loop gain to one of seven levels according to the positioning distance is used. (The settings are common to all axes.)

6151	Distance D1 to the first stage (for inch input)
6152	Distance D2 to the second stage (for inch input)
6153	Distance D3 to the third stage (for inch input)
6154	Distance D4 to the fourth stage (for inch input)
6155	Distance D5 to the fifth stage (for inch input)
6156	Distance D6 to the sixth stage (for inch input)

[Data type] 2–word

[Unit of data]

Increment system	IS–A	IS–B	IS–C	Units
Linear axis (inch input)	0.001	0.0001	0.00001	mm
Rotation axis	0.01	0.001	0.0001	deg

[Valid data range] 0 to 99999999

These parameters set positioning distances when the function for 7–stage switching of the rapid traverse rate, time constant, and loop gain based on positioning distance is used. (These parameters are common to all axes.)

6161	First-stage rapid traverse rate
6162	Second-stage rapid traverse rate
6163	Third-stage rapid traverse rate
6164	Fourth-stage rapid traverse rate
6165	Fifth-stage rapid traverse rate
6166	Sixth-stage rapid traverse rate
6167	Seventh-stage rapid traverse rate

[Data type] 2-word axis

[Unit of data], [Valid data range]

Increment system	Units of data	Valid data range	
		IS-A, IS-B	IS-C
Millimeter machine	1 mm/min	30 to 240000	30 to 100000
Inch machine	0.1 inch/min	30 to 96000	30 to 48000
Rotation axis	1 deg/min	30 to 240000	30 to 100000

Specify rapid traverse rates for each axis.

6171	First-stage rapid traverse time constant
6172	Second-stage rapid traverse time constant
6173	Third-stage rapid traverse time constant
6174	Fourth-stage rapid traverse time constant
6175	Fifth-stage rapid traverse time constant
6176	Sixth-stage rapid traverse time constant
6177	Seventh-stage rapid traverse time constant

[Data type] Word axis

[Unit of data] ms

[Valid data range] 8 to 4000

Specify rapid traverse time constants for each axis.

6181	First-stage rapid traverse servo loop gain
6182	Second-stage rapid traverse servo loop gain
6183	Third-stage rapid traverse servo loop gain
6184	Fourth-stage rapid traverse servo loop gain
6185	Fifth-stage rapid traverse servo loop gain
6186	Sixth-stage rapid traverse servo loop gain
6187	Seventh-stage rapid traverse servo loop gain

[Data type] Word axis

[Unit of data] 0.01 s^{-1}

[Valid data range] 1 to 9999

Specify rapid traverse servo loop gains for each axis.

6191	Time constant T_2 for bell-shaped acceleration/deceleration for first-stage rapid traverse during positioning by optimum acceleration
6192	Time constant T_2 for bell-shaped acceleration/deceleration for second-stage rapid traverse during positioning by optimum acceleration
6193	Time constant T_2 for bell-shaped acceleration/deceleration for third-stage rapid traverse during positioning by optimum acceleration
6194	Time constant T_2 for bell-shaped acceleration/deceleration for fourth-stage rapid traverse during positioning by optimum acceleration
6195	Time constant T_2 for bell-shaped acceleration/deceleration for fifth-stage rapid traverse during positioning by optimum acceleration
6196	Time constant T_2 for bell-shaped acceleration/deceleration for sixth-stage rapid traverse during positioning by optimum acceleration
6197	Time constant T_2 for bell-shaped acceleration/deceleration for seventh-stage rapid traverse during positioning by optimum acceleration

[Data type] Word axis

[Unit of data] ms

[Valid data range] 0 to 512

These parameters set time constant T_2 for bell-shaped acceleration/deceleration for the rapid traverse in each stage of positioning by optimum acceleration for each axis.

4.42 PARAMETERS OF SKIP FUNCTION

	#7	#6	#5	#4	#3	#2	#1	#0
6200	SKF	SRE	SLS	HSS	MIT		SK0	GSK
	SKF	SRE	SLS	HSS			SK0	

[Data type] Bit

GSK In skip cutting (G31), the skip signal SKIPP (bit 6 of G006) is:
 0 : Not used as a skip signal.
 1 : Used as a skip signal.

SK0 This parameter specifies whether the skip signal is made valid under the state of the skip signal SKIP (bit 7 of X004) and the multistage skip signals (bits 0 to 7 of X004) (for the T series only).
 0 : Skip signal is valid when these signals are 1.
 1 : Skip signal is valid when these signals are 0.

MIT In skip cutting (G31), the tool compensation measurement value direct input B signals +MIT1, -MIT1, +MIT2, and -MIT2 (bit 2 to 5 of X004) are :
 0 : Not used as skip signals.
 1 : Used as skip signals.

HSS 0 : The skip function does not use high-speed skip signals.
 1 : The skip function uses high-speed skip signals.

SLS 0 The multi-step skip function does not use high-speed skip signals while skip signals are input.
 1 : The multi-step skip function uses high-speed skip signals while skip signals are input.

SRE When a high-speed skip signal is used:
 0 : The signal is considered to be input at the rising edge (0 → 1).
 1 : The signal is considered to be input at the falling edge (1 → 0).

SKF Dry run, override, and automatic acceleration/deceleration for G31 skip command
 0 : Disabled
 1 : Enabled

	#7	#6	#5	#4	#3	#2	#1	#0
6201	SPE			IGX	TSA	TSE	SEB	SEA
	SPE		CSE	IGX	TSA	TSE	SEB	SEA

[Data type] Bit

SEA When a high speed skip signal goes on while the skip function is used, acceleration/deceleration and servo delay are:
 0 : Ignored.
 1 : Considered and compensated (type A).

SEB When a high speed skip signal goes on while the skip function is used, acceleration/deceleration and servo delay are:
 0 : Ignored.
 1 : Considered and compensated (type B).

NOTE

There are two types of compensation: Types A and B. With the skip function, the current position is stored in the CNC according to the skip signal. However, the current position stored in the CNC contains servo delay. The machine position is therefore deviated by the servo delay. The deviation can be obtained from the position deviation of the servo and the error generated due to feedrate acceleration/deceleration performed by the CNC. If the deviation can be compensated, it is not necessary to include the servo delay in measurement errors. The deviation can be compensated with the following two types by the parameter as follows:

- (1) Type A: The deviation is the value calculated from the cutting time constant and servo time constant (loop gain).
- (2) Type B: The deviation is the error due to acceleration/deceleration and the position deviation when the skip signal goes on.

TSE When the torque limit skip function (G31 P99/98) is used, the skip position held in a system variable is:

- 0 : Position that is offset considering the delay (positional deviation) incurred by the servo system.
- 1 : Position that does not reflect the delay incurred by the servo system.

NOTE

The torque limit skip function stores the current position in the CNC when the torque limit arrival signal is turned on. However, the current position in the CNC includes a servo system delay, so that the position is shifted from the machine position by an amount corresponding to the servo system delay. The value of this shift can be determined from the servo system positional deviation. When TSE is set to 0, a skip position is determined by subtracting the positional deviation from the current position. When TSE is set to 1, the current position (including the servo system delay) is used as the skip position, without considering any shift or position deviation.

TSA When the torque limit skip function (G31 P99/98) is used, torque limit arrival monitoring is performed for:

- 0 : All axes.
- 1 : Only those axes that are specified in the block containing the G31 command.

IGX When the high-speed skip function is used, SKIP (bit 7 of X004), SKIPP (bit 6 of G006), and +MIT1 to -MIT2 (bits 2 to 5 of X004) are:

- 0 : Enabled as skip signals.
- 1 : Disabled as skip signals.

NOTE

- 1 SKIPP (bit 6 of G006) and +MIT1 to –MIT2 (bits 2 to 5 of X004) are enabled only when bit 0 (GSK) of parameter No.6200 is set to 1 and bit 3 (MIT) of parameter No.6200 is set to 1. Note also that these signals are enabled only for the T series.
- 2 The skip signals for the multistage skip function (SKIP, SKIP2 to SKIP8) can also be disabled.

- CSE** For continuous high-speed skip command G31 P90, high-speed skip signals are :
- 0 : Effective at either a rising or falling edge (depending on the setting of bit 6 (SRE) of parameter 6200)
 - 1 : Effective for both the rising and falling edges
- SPE** For the skip function (G31), the skip signal (bit 7 of X004) is:
- 0 : Disabled.
 - 1 : Enabled.

	#7	#6	#5	#4	#3	#2	#1	#0
6202	1S8	1S7	1S6	1S5	1S4	1S3	1S2	1S1
6203	2S8	2S7	2S6	2S5	2S4	2S3	2S2	2S1
6204	3S8	3S7	3S6	3S5	3S4	3S3	3S2	3S1
6205	4S8	4S7	4S6	4S5	4S4	4S3	4S2	4S1
6206	DS8	DS7	DS6	DS5	DS4	DS3	DS2	DS1

[Data type] Bit

1S1 to 1S8 Specify which high-speed skip signal is enabled when the G31 skip command is issued. The bits correspond to the following signals:

- 1S1 — HDI0
- 1S2 — HDI1
- 1S3 — HDI2
- 1S4 — HDI3
- 1S5 — HDI4
- 1S6 — HDI5
- 1S7 — HDI6
- 1S8 — HDI7

1S1 to 1S8, 2S1 to 2S8, 3S1 to 3S8, 4S1 to 4S8, DS1 to DS8

Specify which skip signal is enabled when the skip command (G31, or G31P1 to G31P4) and the dwell command (G04, G04Q1 to G04Q4) are issued with the multi-step skip function.

The following table shows the correspondence between the bits, input signals, and commands.

The setting of the bits have the following meaning :

- 0 : The skip signal corresponding to the bit is disabled.
- 1 : The skip signal corresponding to the bit is enabled.

High-speed skip function	
Command	G31
Input signal	
HDI0	1S1
HDI1	1S2
HDI2	1S3
HDI3	1S4
HDI4	1S5
HDI5	1S6
HDI6	1S7
HDI7	1S8

Multi-step skip function					
Command	G31 G31P1 G04Q1	G31P2 G04Q2	G31P2 G04Q2	G31P4 G04Q4	G04
Input signal					
SKIP/HDI0	1S1	2S1	3S1	4S1	DS1
SKIP2/HDI1	1S2	2S2	3S2	4S2	DS2
SKIP3/HDI2	1S3	2S3	3S3	4S3	DS3
SKIP4/HDI3	1S4	2S4	3S4	4S4	DS4
SKIP5/HDI4	1S5	2S5	3S5	4S5	DS5
SKIP6/HDI5	1S6	2S6	3S6	4S6	DS6
SKIP7/HDI6	1S7	2S7	3S7	4S7	DS7
SKIP8/HDI7	1S8	2S8	3S8	4S8	DS8

NOTE

HDI0 to HDI7 are high-speed skip signals.

	#7	#6	#5	#4	#3	#2	#1	#0
6208								
	9S8	9S7	9S6	9S5	9S4	9S3	9S2	9S1

[Data type] Bit

9S1 to 9S8 Specify valid high-speed skip signals for high-speed skip command G31P90. The bits correspond to signals as follows:

- 9S1 — HDI0
- 9S2 — HDI1
- 9S3 — HDI2
- 9S4 — HDI3
- 9S5 — HDI4
- 9S6 — HDI5
- 9S7 — HDI6
- 9S8 — HDI7

Set each bit as follows:

- 0 : The corresponding skip signal is invalid.
- 1 : The corresponding skip signal is valid.

	#7	#6	#5	#4	#3	#2	#1	#0
6210							ROS	
							ROS	CS3

[Data type] Bit

CS3 As the continuous high-speed skip command:

0 : G31 P90 is used.

1 : G31.9 is used.

With G31 P90, when a high-speed skip signal is input, the absolute coordinates are stored in custom macro variables #5061 through #5068. When the next high-speed skip signal is input, these variables are updated. With G31.9, when a high-speed skip signal is input, the absolute coordinates are sequentially stored in the custom macro variables specified in the G31.9 block.

ROS When the skip position goes beyond the roll-over range, the values of system variables #5061 through #5068 indicating the skip signal position:

0 : Are not rolled over.

1 : Are rolled over similar to the absolute coordinates.

	#7	#6	#5	#4	#3	#2	#1	#0
6215								CST

[Data type] Bit axis

CST For the Cs contour controlled axis, the torque limit skip function is:

0 : Disabled.

1 : Enabled.

The torque limit skip function uses load detection signals LDT1/F045, F049, F196, and F266 for the serial spindle to perform operation for the Cs contour controlled axis. Set the load detection level in parameter No. 4026.

NOTE

This parameter is valid only when the target axis is a Cs contour controlled axis.

When this parameter is set to 1 and the target axis is in the torque limit state in Cs mode, neither in-position check nor excessive error check at stop is performed.

6220	
	Period during which input is ignored for continuous high-speed skip signal

[Data type] Byte type

[Unit of data] 8 ms

[Valid data range] 3 to 127 (\times 8 ms)

If a value that falls outside this range is specified, 3 (\times 8 ms) is assumed. This parameter specifies the period that must elapse between a high-speed skip signal being input and input of the next high-speed skip signal being enabled, for the continuous high-speed skip function. This parameter is used to ignore chattering in skip signals.

NOTE

If a value that falls outside the range is specified, 3 (24 ms) is assumed.

4.43 PARAMETERS OF AUTOMATIC TOOL COMPENSATION (T SERIES) AND AUTOMATIC TOOL LENGTH COMPENSATION (M SERIES)

	#7	#6	#5	#4	#3	#2	#1	#0
6240								AE0

[Data type] Bit

AE0 Measurement position arrival is assumed when the automatic tool compensation signals XAE and ZAE (bits 0 and 1 of X004) (T system) or the automatic tool length measurement signals XAE, YAE, and ZAE (bits 0, 1, and 2 of X004) (M system) are:

0 : 1

1 : 0

6241	Feedrate during measurement of automatic tool compensation
	Feedrate during measurement of automatic tool length compensation

[Data type] Word

Increment system	Unit of data	Valid data range	
		IS-A, IS-B	IS-C
Millimeter machine	1 mm/min	6 to 15000	6 to 12000
Inch machine	0.1 inch/min	6 to 6000	6 to 4800

This parameter sets the feedrate during measurement of automatic tool compensation (T series) and automatic tool length compensation (M series).

6251	γ value on X axis during automatic tool compensation
	γ value during automatic tool length automatic compensation

6252	γ value on Z axis during automatic tool compensation

[Data type] 2-word

[Unit of data]

Increment system	IS-A	IS-B	IS-C	Unit
Millimeter machine	0.01	0.001	0.0001	mm
Inch machine	0.001	0.0001	0.00001	inch

[Valid data range] 1 to 99999999

These parameters set the ϵ value during automatic tool compensation (T series) or tool length automatic compensation (M series).

NOTE

Set a radius value irrespective of whether the diameter programming or the radius programming is specified.

6254	ε value on X axis during automatic tool compensation
	ε value during automatic tool length automatic compensation
6255	ε value on Z axis during automatic tool compensation

[Data type] 2-word

[Unit of data]

Increment system	IS-A	IS-B	IS-C	Unit
Millimeter machine	0.01	0.001	0.0001	mm
Inch machine	0.001	0.0001	0.00001	inch

[Valid data range] 1 to 99999999

These parameters set the ε value during automatic tool compensation (T series) or automatic tool length offset (M series).

NOTE

Set a radius value irrespective of whether the diameter programming or the radius programming is specified.

4.44 PARAMETERS OF EXTERNAL DATA INPUT/OUTPUT

	#7	#6	#5	#4	#3	#2	#1	#0
6300	EEX			ESR	ESC			

[Data type] Bit

ESC When a reset is input between input of the external data input read signal ESTB and execution of a search, the external program number search function:

0 : Performs a search.

1 : Does not perform a search.

ESR External program number search

0 : Disabled

1 : Enabled

EEX PMC EXIN function

0 : Conventional specifications

1 : Extended specifications

If you want to handle data unavailable with the PMC/EXIN command according to the conventional specifications, such as an 8-digit program number, in an external program number search, set this bit to 1.

To use this function for multipath control, the setting for the first path (main) is used. The EXIN specifications cannot be changed for each path. For details of EXIN and how to change ladder software, refer to the PMC specifications and other manuals.

4.45 PARAMETERS OF FINE TORQUE SENSING

	#7	#6	#5	#4	#3	#2	#1	#0
6350	FTS			FTA	FTP	FTM	TQ2	TQ1

[Data type] Bit

TQ2, TQ1 These parameters set the buffering interval for the fine torque sensing function.

TQ2	TQ1	Interval
0	0	8 ms
0	1	16 ms
1	0	32 ms
1	1	Disabled

FTM By the fine torque sensing function, model machining is:
0 : Not monitored.
1 : Monitored.

FTP By the fine torque sensing function, absolute coordinates are:
0 : Not monitored.
1 : Monitored.

FTA The detection level in the torque monitor screen is:
0 : Not associated with the threshold value for an abnormal load detection alarm (parameter No. 2104 (servo) or 4341 (spindle)).
1 : Associated with it.

When this bit is set to 1 and soft key [END] is pressed after the detection level is changed on the torque monitor screen, the detection level is reflected in parameter No. 2104 or 4341.

FTS As spindle data for fine torque sensing:
0 : Disturbance load torque data is used.
1 : All torque data (data for the load meter) is used.

6360	Target axis 1 for fine torque sensing
6361	Target axis 2 for fine torque sensing
6362	Target axis 3 for fine torque sensing
6363	Target axis 4 for fine torque sensing

[Data type] Byte

[Valid data range] -4 to 8

These parameters set the numbers of target controlled axes for fine torque sensing.

Set 1 to 8 for a servo axis and -1 to -4 for a spindle axis.

If a value of 0 is set for target axis 1, no fine torque sensing is performed. When the number of target axes is N, use parameters for target axes 1 to N.

Example)

Parameter	Setting
Target axis 1	1
Target axis 2	2
Target axis 3	0
Target axis 4	3

According to the above settings, sensing is performed only for the first and second axes, and is not performed for the third axis.

4.46

PARAMETERS OF
RETRACING BY THE
MANUAL HANDLE

6400	#7	#6	#5	#4	#3	#2	#1	#0
				HMP	HM8	HM5	HFW	HRP

[Data type] Bit

HRP With the retrace function by the manual handle, the rapid traverse rate is clamped, assuming that:

0 : An override of 10% is used.

1 : An override of 100% is used.

HFW With the retrace function by manual handle, program execution can be performed:

0 : In both forward and backward directions.

1 : Only in the forward direction.

HM8, HM5

HM8	HM5	M code group setting
0	0	Standard (20 groups of four)
0	1	16 groups of five
1	0	10 groups of eight

These parameters set the number of M code groups and the number of M codes in each group.

(See explanations of parameters Nos. 6411 to 6490.)

When 16 groups of five are used, the meanings of parameters are changed as follows:

Group A No.6411(1) to No.6415(5)

Group B No.6416(1) to No.6420(5)

:

Group P No.6486(1) to No.6490(5)

When 10 groups of eight are used, they are changed as follows:

Group A No.6411(1) to No.6418(8)

Group B No.6419(1) to No.6426(8)

:

Group J No.6483(1) to No.6490(8)

HMP When reverse or backward movement is disabled for a path:

0 : Reverse or backward movement is not disabled for other paths.

1 : Reverse or backward movement is also disabled for other paths.

6410	Travel distance per pulse generated from the manual pulse generator for the retrace function by the manual handle

[Data type] Byte

[Unit of data] 1%

[Valid data range] 0 to 100

This parameter sets the travel distance per pulse generated from the manual pulse generator for the retrace function by the manual handle.

This function moves (or dwells) the tool by ([this parameter setting] × [handle magnification])/[pulse of manual pulse generator]).

6411	M code (1) in group A for backward movement by the retrace function by the manual handle
6412	M code (2) in group A for backward movement by the retrace function by the manual handle
6413	M code (3) in group A for backward movement by the retrace function by the manual handle
6414	M code (4) in group A for backward movement by the retrace function by the manual handle
6415	M code (1) in group B for backward movement by the retrace function by the manual handle
6416	M code (2) in group B for backward movement by the retrace function by the manual handle
6417	M code (3) in group B for backward movement by the retrace function by the manual handle
6418	M code (4) in group B for backward movement by the retrace function by the manual handle
6419	M code (1) in group C for backward movement by the retrace function by the manual handle
6420	M code (2) in group C for backward movement by the retrace function by the manual handle
6421	M code (3) in group C for backward movement by the retrace function by the manual handle
6422	M code (4) in group C for backward movement by the retrace function by the manual handle

6423	M code (1) in group D for backward movement by the retrace function by the manual handle
6424	M code (2) in group D for backward movement by the retrace function by the manual handle
6425	M code (3) in group D for backward movement by the retrace function by the manual handle
6426	M code (4) in group D for backward movement by the retrace function by the manual handle
6427	M code (1) in group E for backward movement by the retrace function by the manual handle
6428	M code (2) in group E for backward movement by the retrace function by the manual handle
6429	M code (3) in group E for backward movement by the retrace function by the manual handle
6430	M code (4) in group E for backward movement by the retrace function by the manual handle
6431	M code (1) in group F for backward movement by the retrace function by the manual handle
6432	M code (2) in group F for backward movement by the retrace function by the manual handle
6433	M code (3) in group F for backward movement by the retrace function by the manual handle
6434	M code (4) in group F for backward movement by the retrace function by the manual handle

6435	M code (1) in group G for backward movement by the retrace function by the manual handle
6436	M code (2) in group G for backward movement by the retrace function by the manual handle
6437	M code (3) in group G for backward movement by the retrace function by the manual handle
6438	M code (4) in group G for backward movement by the retrace function by the manual handle
6439	M code (1) in group H for backward movement by the retrace function by the manual handle
6440	M code (2) in group H for backward movement by the retrace function by the manual handle
6441	M code (3) in group H for backward movement by the retrace function by the manual handle
6442	M code (4) in group H for backward movement by the retrace function by the manual handle
6443	M code (1) in group I for backward movement by the retrace function by the manual handle
6444	M code (2) in group I for backward movement by the retrace function by the manual handle
6445	M code (3) in group I for backward movement by the retrace function by the manual handle
6446	M code (4) in group I for backward movement by the retrace function by the manual handle

6447	M code (1) in group J for backward movement by the retrace function by the manual handle
6448	M code (2) in group J for backward movement by the retrace function by the manual handle
6449	M code (3) in group J for backward movement by the retrace function by the manual handle
6450	M code (4) in group J for backward movement by the retrace function by the manual handle
6451	M code (1) in group K for backward movement by the retrace function by the manual handle
6452	M code (2) in group K for backward movement by the retrace function by the manual handle
6453	M code (3) in group K for backward movement by the retrace function by the manual handle
6454	M code (4) in group K for backward movement by the retrace function by the manual handle
6455	M code (1) in group L for backward movement by the retrace function by the manual handle
6456	M code (2) in group L for backward movement by the retrace function by the manual handle
6457	M code (3) in group L for backward movement by the retrace function by the manual handle
6458	M code (4) in group L for backward movement by the retrace function by the manual handle

6459	M code (1) in group M for backward movement by the retrace function by the manual handle
6460	M code (2) in group M for backward movement by the retrace function by the manual handle
6461	M code (3) in group M for backward movement by the retrace function by the manual handle
6462	M code (4) in group M for backward movement by the retrace function by the manual handle
6463	M code (1) in group N for backward movement by the retrace function by the manual handle
6464	M code (2) in group N for backward movement by the retrace function by the manual handle
6465	M code (3) in group N for backward movement by the retrace function by the manual handle
6466	M code (4) in group N for backward movement by the retrace function by the manual handle
6467	M code (1) in group O for backward movement by the retrace function by the manual handle
6468	M code (2) in group O for backward movement by the retrace function by the manual handle
6469	M code (3) in group O for backward movement by the retrace function by the manual handle
6470	M code (4) in group O for backward movement by the retrace function by the manual handle

6471	M code (1) in group P for backward movement by the retrace function by the manual handle
6472	M code (2) in group P for backward movement by the retrace function by the manual handle
6473	M code (3) in group P for backward movement by the retrace function by the manual handle
6474	M code (4) in group P for backward movement by the retrace function by the manual handle
6475	M code (1) in group Q for backward movement by the retrace function by the manual handle
6476	M code (2) in group Q for backward movement by the retrace function by the manual handle
6477	M code (3) in group Q for backward movement by the retrace function by the manual handle
6478	M code (4) in group Q for backward movement by the retrace function by the manual handle
6479	M code (1) in group R for backward movement by the retrace function by the manual handle
6480	M code (2) in group R for backward movement by the retrace function by the manual handle
6481	M code (3) in group R for backward movement by the retrace function by the manual handle
6482	M code (4) in group R for backward movement by the retrace function by the manual handle

6483	M code (1) in group S for backward movement by the retrace function by the manual handle
6484	M code (2) in group S for backward movement by the retrace function by the manual handle
6485	M code (3) in group S for backward movement by the retrace function by the manual handle
6486	M code (4) in group S for backward movement by the retrace function by the manual handle
6487	M code (1) in group T for backward movement by the retrace function by the manual handle
6488	M code (2) in group T for backward movement by the retrace function by the manual handle
6489	M code (3) in group T for backward movement by the retrace function by the manual handle
6490	M code (4) in group T for backward movement by the retrace function by the manual handle

[Data type] Word

[Unit of data] 0 to 9999

These parameters set the M codes in each group for backward movement by the retrace function by the manual handle.

For backward movement for an M code, the modal M code in the same group set by the parameter is output. The first M code in each group is set as the default at a reset.

When the number of M codes in a group is 3 or less, set the parameter corresponding to an unused M code to 0.

(For backward movement for “M0”, “M0” is output regardless of which M code is set for the parameter.)

For an M code which is not set in any group by any of the above parameters, the M code for forward movement is output.

NOTE

The names of the above parameters Nos. 6411 to 6490 indicate those when 20 groups of four M codes are used for convenience of explanation.

The actual numbers of groups and of M codes in each group are determined according to the settings of bits 3 (HM8) and 2 (HM5) of parameter No. 6400. Also see the explanation of those parameters when setting the above parameters.

4.47 PARAMETERS OF GRAPHIC DISPLAY

4.47.1

Parameters of Graphic Display/Dynamic Graphic Display

6500	#7	#6	#5	#4	#3	#2	#1	#0
		NZM			DPA	GUL	SPC	GRL
			DPO					

[Data type] Bit

- GRL** Graphic display (2-path control)
 0 : Path 1 is displayed on the left, and path 2 is displayed on the right.
 1 : Path 1 is displayed on the right, and path 2 is displayed on the left.
- SPC** Graphic display (2-path control) is done
 0 : on two spindles and two tool posts
 1 : on one spindle and two tool posts
- GUL** 0 : The positions of X1- and X2-axes are not replaced with each other in the coordinate system specified with parameter 6509.
 1 : The positions of X1- and X2-axes are replaced with each other in the coordinate system specified with parameter 6509.

NOTE

This bit is for two-path control.

- DPA** Current position display on the graphic display screen
 0 : Displays the actual position to ensure tool nose radius compensation
 1 : Displays the programmed position
- DPO** Current position on the solid drawing (machining profile drawing) or tool path drawing screen
 0 : Not appear
 1 : Appears
- NZM** 0 : The screen image is not enlarged by specifying the center of the screen and magnification. (Screen image enlargement by a conventional method is enabled.)
 1 : The screen image is enlarged by specifying the center of the screen and magnification. (Screen image enlargement by the conventional method is disabled.)

6501	#7	#6	#5	#4	#3	#2	#1	#0
			CSR					
			CSR	FIM	RID	3PL	TLC	ORG

[Data type] Bit

- ORG** Movement when coordinate system is altered during drawing
 0 : Draws in the same coordinate system
 1 : Draws in the new coordinate system (only for the path drawing)
- TLC** In solid drawing
 0 : Not compensate the tool length
 1 : Compensates the tool length
- 3PL** Tri-plane drawing in solid drawing
 0 : Drawn by the first angle projection
 1 : Drawn by the third angle projection

- RID** In solid drawing
 0 : Draws a plane without edges.
 1 : Draws a plane with edges.
- FIM** Machining profile drawing in solid drawing
 0 : Displayed in the coarse mode
 1 : Displayed in the fine mode
- CSR** While the screen image is enlarged, the shape of the graphic cursor is:
 0 : A square. (■)
 1 : An X. (X)

	#7	#6	#5	#4	#3	#2	#1	#0
6503						CYG		
							MST	

[Data type] Bit

- MST** In check drawing (animated simulation) using the dynamic graphic display function, the M, S, and T code commands in the program are:
 0 : Ignored.
 1 : Output to the machine in the same way as in normal operation.

- CYG** CY-axis drawing coordinate system setting
 0 : The CY-axis animated simulation coordinate system is not set.
 1 : The CY-axis animated simulation coordinate system is set.

When this parameter is set to “1”, parameter No. 6510 is invalid.

When bit 1 (SPC) of parameter No. 6500 is set to “1”, this parameter is invalid.

6509	Coordinate system for drawing a single spindle (2-path control)

[Data type] Byte

[Valid data range] 0 to 7 and 10 to 17 (However, 0 to 7 are the same settings as 10 to 17.)

This parameter sets the coordinate system for drawing a single spindle (bit 1 of parameter 6500 = 1) for 2-path control.

The following shows the relationship between the settings and the drawing coordinate systems:

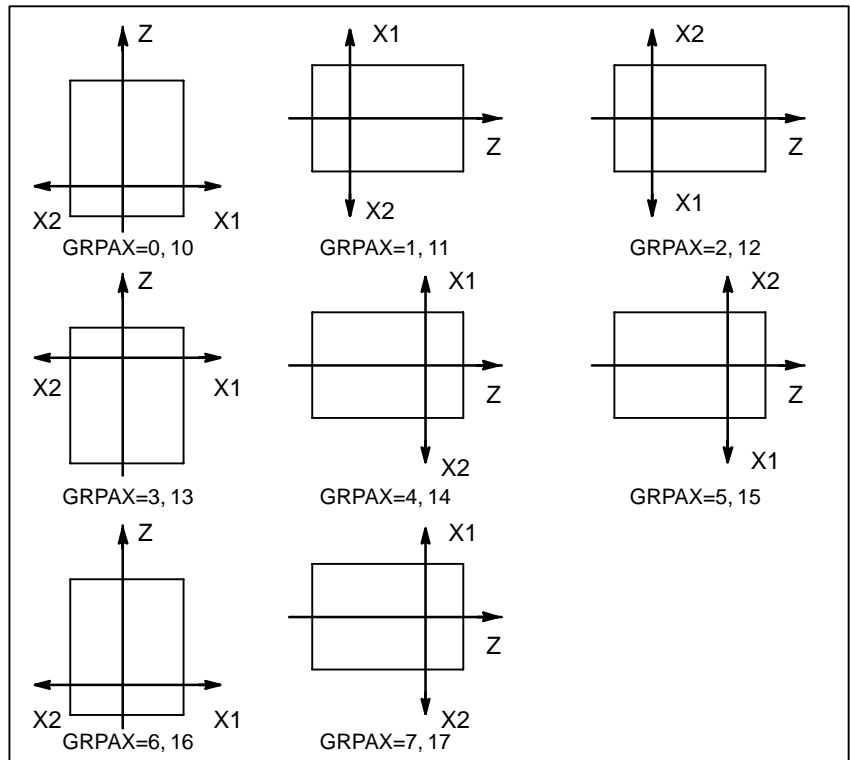

6510	Drawing coordinate system
------	---------------------------

[Data type] Byte
[Valid data range] 0 to 7

This parameter specifies the drawing coordinate system for the graphic function.

The following show the relationship between the set values and the drawing coordinate systems.

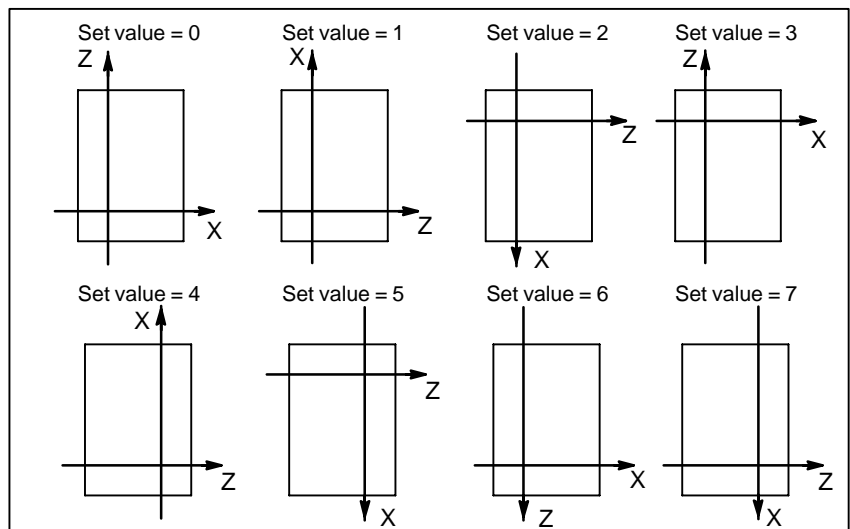

NOTE

This parameter is specified for each tool post in the 2-path control. A different drawing coordinate system can be selected for each tool post.

6511	
	Right margin in solid drawing
6512	
	Left margin in solid drawing
6513	
	Upper margin in solid drawing
6514	
	Lower margin in solid drawing

[Data type] Word

[Unit of data] Dot

These parameters set the machining profile drawing position in margins. The unit is a dot.

Parameter No.	Margin area	Standard set value			
		DPO(No.6500#5)=0		DPO(No.6500#5)=1	
		7.2"LCD 8.4"LCD	9.5"LCD 10.4"LCD	7.2"LCD 8.4"LCD	9.5"LCD 10.4"LCD
6511	Right	0	0	200	100
6512	Left	0	0	0	0
6513	Upper	25	32	25	32
6514	Lower	0	10	0	10

DPO is set in bit 5 (DPO) of parameter No. 6500.

6515	
	Change in cross-section position in tri-plane drawing

[Data type] Byte

[Unit of data] Dot

[Valid data range] 0 to 10

This parameter sets the change in the cross-section position when a soft key is continuously pressed in tri-plane drawing. When zero is specified, it is set to 1.

6520	
	C-axis number for dynamic graphic display

[Data type] Byte

[Valid data range] 0, 1 to number of controlled axes

This parameter sets a C-axis number for dynamic graphic display. When 0 or a value greater than the number of controlled axes is specified with this parameter, the third axis is assumed.

4.47.2**Parameters of Graphic Color**

6561	Standard color data for graphic color number 1
6562	Standard color data for graphic color number 2
6563	Standard color data for graphic color number 3
6564	Standard color data for graphic color number 4
6565	Standard color data for graphic color number 5
6566	Standard color data for graphic color number 6
6567	Standard color data for graphic color number 7
6568	Standard color data for graphic color number 8
6569	Standard color data for graphic color number 9
6570	Standard color data for graphic color number 10
6571	Standard color data for graphic color number 11
6572	Standard color data for graphic color number 12
6573	Standard color data for graphic color number 13
6574	Standard color data for graphic color number 14
6575	Standard color data for graphic color number 15
6581	Standard color data for character color number 1
6582	Standard color data for character color number 2
6583	Standard color data for character color number 3
6584	Standard color data for character color number 4
6585	Standard color data for character color number 5
6586	Standard color data for character color number 6
6587	Standard color data for character color number 7
6588	Standard color data for character color number 8
6589	Standard color data for character color number 9
6590	Standard color data for character color number 10
6591	Standard color data for character color number 11
6592	Standard color data for character color number 12
6593	Standard color data for character color number 13
6594	Standard color data for character color number 14
6595	Standard color data for character color number 15

[Data type] 2–word

[Unit of data] rr gg bb: 6–digit number (rr: Red gg: Green bb: Blue)

When a number of less than six digits is set, the system assumes that 0 has been specified for the unspecified higher digit(s).

[Valid data range] Data of each color: 00 to 15 (same value as the tone level data on the color setting screen)

When a value of more than 15 is set, the system assumes that 15 has been specified.

Example: Set 10203 in this parameter when the color tone levels are as follows:

Red: 1 Green: 2 Blue: 3

NOTE

To set the color of the VGA display, use the color setting screen. Note that the color changes when the settings of parameters No.6561 through No.6595 are modified.

4.48 PARAMETERS OF DISPLAYING OPERATION TIME AND NUMBER OF PARTS

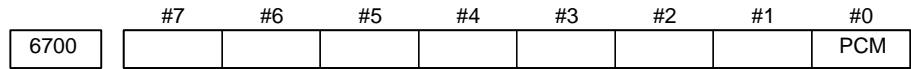

[Data type] Bit

PCM M code that counts the total number of machined parts and the number of machined parts
 0 : M02, or M30, or an M code specified by parameter No.6710
 1 : Only M code specified by parameter No.6710

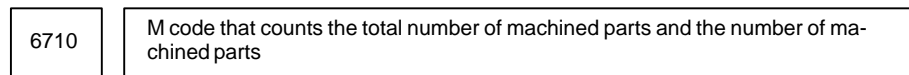

[Data type] Byte

[Valid data range] 0 to 255 except 98 and 99

The total number of machined parts and the number of machined parts are counted (+1) when the M code set is executed.

NOTE
 Set value 0 is invalid (the number of parts is not counted for M00). Data 98 and 99 cannot be set.

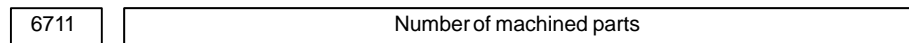

Setting entry is acceptable.

[Data type] 2-word

[Unit of data] One piece

[Valid data range] 0 to 99999999

The number of machined parts is counted (+1) together with the total number of machined parts when the M02, M30, or a M code specified by parameter No.6710 is executed.

NOTE
 The number of parts is not counted for M02, M03, when bit 0 (PCM) of parameter No. 6700 is set to 1.

6712	Total number of machined parts
------	--------------------------------

Setting entry is acceptable.

[Data type] 2-word

[Unit of data] One piece

[Valid data range] 0 to 99999999

This parameter sets the total number of machined parts.

The total number of machined parts is counted (+1) when M02, M30, or an M code specified by parameter No.6710 is executed.

NOTE

The number of parts is not counted for M02, M03, when bit 0 (PCM) of parameter No. 6700 is set to 1.

6713	Number of required parts
------	--------------------------

Setting entry is acceptable.

[Data type] Word

[Unit of data] One piece

[Valid data range] 0 to 9999

This parameter sets the number of required machined parts.

Required parts finish signal PRTSF is output to PMC when the number of machined parts reaches the number of required parts. The number of parts is regarded as infinity when the number of required parts is zero. The PRTSF signal is then not output.

6750	Integrated value of power-on period
------	-------------------------------------

Setting entry is acceptable.

[Data type] 2-word

[Unit of data] One min

[Valid data range] 0 to 99999999

This parameter displays the integrated value of power-on period.

6751	Operation time (integrated value of time during automatic operation) I
------	--

Setting entry is acceptable.

[Data type] 2-word

[Unit of data] One ms

[Valid data range] 0 to 60000

6752

Operation time (integrated value of time during automatic operation) II

Setting entry is acceptable.

[Data type] 2-word**[Unit of data]** One min**[Valid data range]** 0 to 99999999

This parameter displays the integrated value of time during automatic operation (neither stop nor hold time included).

The actual time accumulated during operation is the sum of this parameter No. 6751 and parameter No. 6752.

6753

Integrated value of cutting time I

Setting entry is acceptable.

[Data type] 2-word**[Unit of data]** One ms**[Valid data range]** 1 to 60000

6754

Integrated value of cutting time II

Setting entry is acceptable.

[Data type] 2-word**[Unit of data]** One min**[Valid data range]** 0 to 99999999

This parameter displays the integrated value of a cutting time that is performed in cutting feed such as linear interpolation (G01) and circular interpolation (G02 or G03).

The actual time accumulated during cutting is the sum of this parameter No. 6753 and parameter No. 6754.

6755

Integrated value of general-purpose integrating meter drive signal (TMRON) ON time I

Setting entry is acceptable.

[Data type] 2-word**[Unit of data]** One ms**[Valid data range]** 0 to 60000

6756	Integrated value of general-purpose integrating meter drive signal (TMRON) ON time II
------	--

Setting entry is acceptable.

[Data type] 2-word

[Unit of data] One min

[Valid data range] 0 to 99999999

This parameter displays the integrated value of a time while input signal TMRON from PMC is on.

The actual integrated time is the sum of this parameter No. 6755 and parameter No. 6756.

6757	Operation time (integrated value of one automatic operation time) I
------	---

Setting entry is acceptable.

[Data type] 2-word

[Unit of data] One ms

[Valid data range] 0 to 60000

6758	Operation time (integrated value of one automatic operation time) II
------	--

Setting entry is acceptable.

[Data type] 2-word

[Unit of data] One min

[Valid data range] 0 to 99999999

This parameter displays the one automatic operation drive time (neither stop nor hold state included). The actual time accumulated during operating is the sum of this parameter No. 6757 and parameter No. 6758. The operation time is automatically preset to 0 during the power-on sequence and the cycle start from the reset state.

4.49 PARAMETERS OF TOOL LIFE MANAGEMENT

6800	#7	#6	#5	#4	#3	#2	#1	#0
	M6T	IGI	SNG	GRS	SIG	LTM	GS2	GS1

[Data type] Bit

GS1, GS2 This parameter sets the combination of the number of tool life groups which can be entered, and the number of tools which can be entered per group as shown in the table below.

GS2	GS1	M series		T series	
		Group count	Tool count	Group count	Tool count
0	0	1 to 16 1 to 64	1 to 16 1 to 32	1 to 16 1 to 16	1 to 16 1 to 32
0	1	1 to 32 1 to 128	1 to 8 1 to 16	1 to 32 1 to 32	1 to 8 1 to 16
1	0	1 to 64 1 to 256	1 to 4 1 to 8	1 to 64 1 to 64	1 to 4 1 to 8
1	1	1 to 128 1 to 512	1 to 2 1 to 4	1 to 16 1 to 128	1 to 16 1 to 4

The values on the lower row in the table apply when for the M series, the 512-tool-life-management-group option is provided, and for the T series, the 128-tool-life-management-group option is provided.

LTM Tool life

0 : Specified by the number of times
1 : Specified by time

SIG Group number is

0 : Not input using the tool group signal during tool skip (The current group is specified.)
1 : Input using the tool group signal during tool skip

GRS Tool exchange reset signal

0 : Clears only the execution data of a specified group
1 : Clears the execution data of all entered groups

SNG Input of the tool skip signal when a tool that is not considered tool life management is selected.

0 : Skips the tool of the group used last or of the specified group (using SIG, #3 of parameter No.6800).
1 : Ignores a tool skip signal

IGI Tool back number

0 : Not ignored
1 : Ignored

M6T T code in the same block as M06

0 : Judged as a back number
1 : Judged as a next tool group command

	#7	#6	#5	#4	#3	#2	#1	#0
6801		EXG	E1S				TSM	
	M6E	EXT	E1S		EMD	LFV		

[Data type] Bit

- TSM** When a tool takes several tool numbers, life is counted in tool life management:
0 : For each of the same tool numbers.
1 : For each tool.
- LFV** Specifies whether life count override is enabled or disabled when the extended tool life management function is used.
0 : Disabled
1 : Enabled
- EMD** An asterisk (*) indicating that a tool has been expired is displayed,
0 : When the next tool is selected
1 : When the tool life is expired
- E1S** When the life of a tool is measured in time-based units:
0 : The life is counted every four seconds.
1 : The life is counted every second. (The maximum life is 1075 (minutes).)

NOTE

This parameter is valid when bit 2 (LTM) of parameter No.6800 is set to 1.

- EXT** Specifies whether the extended tool life management function is used.
0 : Not used
1 : Used
- EXG** Tool life management data registration by G10 (T series) is:
0 : Performed after the data for all tool groups has been cleared.
1 : Performed by adding/changing or deleting the data for a specified group.

NOTE

When EXG = 1, address P in the block including G10 can be used to specify whether data is to be added/changed or deleted (P1: add/change, P2: delete). When P is not specified, the data for all tool groups is cleared before the tool life management data is registered.

- M6E** When a T code is specified in the same block as M06
0 : The T code is processed as a return number or as a group number selected next. Either is set by parameter M6T No.6800#7.
1 : The tool group life is counted immediately.

	#7	#6	#5	#4	#3	#2	#1	#0
6802								T99
		TSK	TGN	ARL	GRP	E17	TCO	T99

[Data type] Bit

T99 If a tool group whose life has expired is found to exist when M99 is executed in the main program:
 0 : The tool change signal is not output.
 1 : The tool change signal is output.

TCO When function code 171 or 172 (tool life management data write) of the PMC window function is specified, tool data of a tool in the currently selected group that is currently not in use:
 0 : Cannot be cleared.
 1 : Can be cleared.

E17 When function code 171 or 172 (tool life management data write) of the PMC window function is specified to clear tool life management data of the tool currently in use in the currently selected group:
 0 : The tool data is not cleared and operation terminates normally.
 1 : The tool data is not cleared and completion code 13 is output.

GRP As management data for the tool life arrival notice signal (TLCHB):
 0 : Parameters Nos. 6844 and 6845 are used.
 1 : The value set for each group with the extended tool life management function is used.

By setting the remaining life until new tool selection for each group, the signal (TLCHB) is output when the value obtained by subtracting the tool use count (COUNT) from the life setting (LIFE) reaches the value (remaining life) set for each group.

ARL The tool life arrival notice signal (TLCHB) of tool life management is:
 0 : Output for each tool.
 1 : Output for the last tool in a group.

This parameter is valid only when bit 3 of parameter No. 6802 is set to 1.

TGN In tool life management B, the arbitrary group number set function is:
 0 : Not used.
 1 : Used.

TSK When the life is specified by time and the last tool in a group is skipped in tool life management:
 0 : The count for the last tool indicates the life value.
 1 : The count for the last tool is not changed.

	#7	#6	#5	#4	#3	#2	#1	#0
6803							LFE	LGR
							LFE	

NOTE

After this parameter has been set, the power must be turned off then on again for the setting to become effective.

[Data type] Bit

- LGR** When the tool life management function is used, a tool life type is:
 0 : Chosen based on the LTM parameter (bit 2 of parameter No.6800) for all groups.
 1 : Set to either count or duration on a group-by-group basis.

When LGR is set to 1, the specification of address Q is added to the G10 (tool life management data setting) command format. As shown in the example below, specify the tool life of each group as either a count or a duration. If address Q is omitted for a group, the specification of the LTM parameter (bit 2 of parameter No.6800) applies to the group.

Example: When the LTM parameter (bit 2 of parameter No.6800) is set to 0

```
G10 L3 ;
P1 L10 Q1 ; (Q1: The life of group 1 is specified as a count.)
:
P2 L20 Q2 ; (Q2: The life of group 2 is specified as a duration.)
:
P3 L20 ;
(Omission of Q: The life of group 3 is specified as a count.)
:
G11 ;
M30 ;
%
```

- LFE** When a tool life is specified by count:
 0 : A count value from 0 to 9999 can be specified.
 1 : A count value from 0 to 65535 can be specified.

	#7	#6	#5	#4	#3	#2	#1	#0
6804							TC1	
						ETE	TC1	E10

[Data type] Bit

- E10** When the life of a tool is specified by time:
 0 : The life is counted every four seconds.
 1 : The life is counted every ten seconds.
- TC1** During automatic operation, preset of the tool life counter is:
 0 : Disabled.
 1 : Enabled.
- ETE** In extended tool life management, as the mark indicating that the life of the last tool in a group has expired:
 0 : "@" is also used.
 1 : "*" is used.

6810	
	Tool life management ignored number

[Data type] Word

[Valid data range] 0 to 9999

This parameter sets the tool life management ignored number.

When the set value is subtracted from a T code, a remainder is used as the tool group number of tool life management when a value exceeding the set value is specified in the T code.

6811	Tool life count restart M code

[Data type] Byte

[Valid data range] 0 to 255 (not including 01, 02, 30, 98, and 99)

When zero is specified, it is ignored.

When the life is specified by the number of times, the tool exchange signal is output when a tool life count restart M code is specified if tool life of at least one tool group is expired. A tool in life is selected in the specified group when a T code command (tool group command) is specified after the tool life count restart M code is specified. A tool life counter is then incremented by one.

When the life is specified by time, a tool in life is selected in the specified group when a T code command (tool group command) is specified after the tool life count restart M code is specified.

6844	
	Remaining tool life (use count)

[Data type] Word

[Unit of data] Count

[Valid data range] 0 to 9999

This parameter sets a remaining tool life (use count) used to output the tool life arrival notice signal when the tool life is specified as a use count.

NOTE

- 1 When the remaining life (use count) of a selected tool reaches the value specified with parameter No.6844, tool life arrival notice signal TLCHB is output to the PMC.
- 2 If a value greater than the life of a tool is specified with parameter No.6844, the tool life arrival notice signal is not output.

6845	
	Remaining tool life (use duration)

[Data type] 2-word

[Unit of data] min

[Valid data range] 0 to 4300

This parameter sets the remaining tool life (use duration), used to output the tool life arrival notice signal when the tool life is specified as a use duration.

NOTE

- 1 When the remaining life (use duration) of a selected tool reaches the value specified in parameter No.6845, tool life arrival notice signal TLCHB is output to the PMC. The tool life management function allows the user to specify a tool life either as a use duration or use count for each tool group. For a group whose life is specified as a use count, parameter No.6844 is used. For a group whose life is specified as a use time, parameter No.6845 is used.
- 2 If a value greater than the life of a tool is specified with parameter No.6845, the tool life arrival notice signal is not output.

4.50 PARAMETERS OF POSITION SWITCH FUNCTIONS

	#7	#6	#5	#4	#3	#2	#1	#0
6901					PSF	PCM	EPS	IGP

[Data type] Bit

IGP During follow-up for the absolute position detector, position switch signals are:

0 : Output

1 : Not output

EPS The number of position switches is:

0 : Not increased.

1 : Increased.

PCM Position switch signals are output:

0 : Without considering acceleration/deceleration and servo delay.

1 : With considering acceleration/deceleration and servo delay.

PSF In high-precision contour control mode (M series), AI contour control mode (M series), AI nano-contour control mode (M series), or look-ahead control mode, position switches are:

0 : Not used.

1 : Used.

6910	Axis corresponding to the first position switch
6911	Axis corresponding to the second position switch
6912	Axis corresponding to the third position switch
6913	Axis corresponding to the fourth position switch
6914	Axis corresponding to the fifth position switch
6915	Axis corresponding to the sixth position switch
6916	Axis corresponding to the seventh position switch
6917	Axis corresponding to the eighth position switch
6918	Axis corresponding to the ninth position switch
6919	Axis corresponding to the tenth position switch
6920	Axis corresponding to the eleventh position switch
6921	Axis corresponding to the twelfth position switch
6922	Axis corresponding to the thirteenth position switch
6923	Axis corresponding to the fourteenth position switch
6924	Axis corresponding to the fifteenth position switch
6925	Axis corresponding to the sixteenth position switch

[Data type] Byte

[Valid data range] 0 to Number of controlled axes

These parameters sequentially specify the numbers of the controlled axes corresponding to the 1st through 16th position switch functions. The corresponding position switch signal is output to the PMC when the machine coordinate of the corresponding axis is within the range set in parameters.

NOTE

Set 0 for the number corresponding to a position switch which is not to be used.

6930	Maximum operation range of the first position switch
6931	Maximum operation range of the second position switch
6932	Maximum operation range of the third position switch
6933	Maximum operation range of the fourth position switch
6934	Maximum operation range of the fifth position switch
6935	Maximum operation range of the sixth position switch
6936	Maximum operation range of the seventh position switch
6937	Maximum operation range of the eighth position switch
6938	Maximum operation range of the ninth position switch
6939	Maximum operation range of the tenth position switch
6940	Maximum operation range of the eleventh position switch
6941	Maximum operation range of the twelfth position switch
6942	Maximum operation range of the thirteenth position switch
6943	Maximum operation range of the fourteenth position switch
6944	Maximum operation range of the fifteenth position switch
6945	Maximum operation range of the sixteenth position switch

[Data type] 2-word

[Unit of data]

Increment system	IS-A	IS-B	IS-C	Unit
Metric machine	0.01	0.001	0.0001	mm
Inch machine	0.001	0.0001	0.00001	inch
Rotation axis	0.01	0.001	0.0001	deg

[Valid data range] -99999999 to 99999999

These parameters sequentially set the maximum operation ranges of the 1st through 16th position switches.

6950	Minimum operation range of the first position switch
6951	Minimum operation range of the second position switch
6952	Minimum operation range of the third position switch
6953	Minimum operation range of the fourth position switch
6954	Minimum operation range of the fifth position switch
6955	Minimum operation range of the sixth position switch
6956	Minimum operation range of the seventh position switch
6957	Minimum operation range of the eighth position switch
6958	Minimum operation range of the ninth position switch
6959	Minimum operation range of the tenth position switch
6960	Minimum operation range of the eleventh position switch
6961	Minimum operation range of the twelfth position switch
6962	Minimum operation range of the thirteenth position switch
6963	Minimum operation range of the fourteenth position switch
6964	Minimum operation range of the fifteenth position switch
6965	Minimum operation range of the sixteenth position switch

[Data type] 2-word

[Unit of data]

Increment system	IS-A	IS-B	IS-C	Unit
Metric machine	0.01	0.001	0.0001	mm
Inch machine	0.001	0.0001	0.00001	inch
Rotation axis	0.01	0.001	0.0001	deg

[Valid data range] -99999999 to 99999999

These parameters sequentially set the minimum operation ranges of the 1st through 16th position switches.

4.51 PARAMETERS OF MANUAL OPERATION AND AUTOMATIC OPERATION

	#7	#6	#5	#4	#3	#2	#1	#0
7001	MFM				JSP	JST		MIN

[Data type] Bit

MIN The manual intervention and return function is:

- 0 : Disabled.
- 1 : Enabled.

JST In manual numerical specification, the STL signal indicating that automatic operation is being started is:

- 0 : Not output.
- 1 : Output.

JSP For the manual numeric command function, spindle control by the CNC is:

- 0 : Not enabled.
- 1 : Enabled.

MFM For the manual linear or circular interpolation function, modifying a value specified with a command during jog feed in the guidance direction (approach direction):

- 0 : Immediately starts moving according to the new value.
- 1 : Stops moving.

	#7	#6	#5	#4	#3	#2	#1	#0
7002					JBF		JSF	JMF
					JBF	JTF	JSF	JMF

[Data type] Bit

JMF In manual numerical specification, M function specification is:

- 0 : Allowed.
- 1 : Not allowed.

JSF In manual numerical specification, S function specification is:

- 0 : Allowed.
- 1 : Not allowed.

JTF In manual numerical specification, T function specification is:

- 0 : Allowed.
- 1 : Not allowed.

JBF In manual numerical specification, B function specification is:

- 0 : Allowed.
- 1 : Not allowed.

	#7	#6	#5	#4	#3	#2	#1	#0
7010								JMVx

[Data type] Bit axis

JMVx In manual numerical specification, axis movement specification is:

- 0 : Allowed.
- 1 : Not allowed. (When the command is specified, a warning message is displayed, and the command is not executed.)

7015	Least command increment setting for jog feed
------	--

[Data type] Word

[Unit of data]

Increment system	IS-A	IS-B	IS-C	Unit
Metric machine	0.01	0.001	0.0001	mm
Inch machine	0.001	0.0001	0.00001	inch
Rotation axis	0.01	0.001	0.0001	deg

[Valid data range] 0 to 10000

This parameter sets the least command increment for jog feed when PMC signal JGUNIT <bit 0 of G0023> is set to 1. If the setting of this parameter is 0, a value of 1 is recognized.

	#7	#6	#5	#4	#3	#2	#1	#0
7050		MI1	MI0					RV1

NOTE
After setting this parameter, turn off the power. Then, turn the power back on to enable the setting.

[Data type] Bit

- RV1** When the tool moves backwards after feed hold during forward feed with the retrace function:
 0 : The block is split at the feed hold position and stored.
 1 : The block is stored without being split.

Command block in program
 -----*----->

If the tool moves backwards after feed hold at position indicated with *

When RV1 = 0
 The block is split into two blocks and stored.

----->----->

When RV1 = 1
 The block is stored as is.

----->

MI0, MI1 Set a batch pass quantity in AI control mode.

MI1	MI0	Batch pass quantity
0	0	1
0	1	2

	#7	#6	#5	#4	#3	#2	#1	#0
7051								
					ACR			

[Data type] Bit

ACR When rigid tapping is specified in AI contour control mode, the mode is:
 0 : Not turned off.
 1 : Turned off.

When the serial spindle does not support look-ahead control of rigid tapping, AI contour control mode must be turned off in rigid tapping.

Setting this parameter and satisfying the following conditions can automatically turn AI contour control mode off only during execution of rigid tapping when rigid tapping is specified in AI contour control mode.

Conditions

- To specify rigid mode, use “the method for specifying M29 S**** prior to the tapping command.”
 If a method other than the above is used, P/S alarm No. 5110 is issued.
- The interval between M29 (rigid mode specification M code) and the completion signal (FIN) must be at least 32 msec.
- The rigid mode cancel command and cutting feed move command cannot be specified simultaneously. If they are specified simultaneously, P/S alarm No. 5110 is issued.
 (Additional information: The rigid mode cancel command and rapid traverse move command can be specified in the same block.)
- Set bit 2 (CRG) of parameter No. 5200 to 0.
 (This setting specifies that rigid tapping mode is canceled when the rigid tapping signal RGTAP is set to “0”.)

	#7	#6	#5	#4	#3	#2	#1	#0
7052								
								NMI

NOTE

After this parameter has been set, the power must be turned off.

[Data type] Bit

NMI In AI contour control mode, batch pass for each axis is:
 0 : Enabled.
 1 : Disabled.

NOTE

For a PMC-based controlled axis or Cs axis, set 1 for this parameter.

	#7	#6	#5	#4	#3	#2	#1	#0
7053								
								NAN

NOTE

When this parameter has been set, the power must be turned off before operation is continued.

[Data type] Bit

NAN G5.1Q1 specifies:

- 0 : AI nano-contour control
- 1 : AI contour control

	#7	#6	#5	#4	#3	#2	#1	#0
7054								
			AIL		AZR		AIR	HPL

[Data type] Bit

HPL If HPCC mode is specified in AI contour control mode and a command unavailable in HPCC mode is found, the NC processes the command:

- 0 : In normal mode.
- 1 : In AI contour control mode.

AIR In AI contour control mode, the rapid traverse type is:

- 0 : Linear interpolation type.
- 1 : According to the setting of bit 1 (LRP) of parameter No. 1401.

AZR In AI contour control mode, the G27, G28, G30, G30.1, and G53 commands are executed:

- 0 : In normal mode. (Look-ahead feed forward is valid.)
- 1 : In AI contour control mode.

AIL When non-linear type positioning is specified in AI contour control mode and an axis-by-axis interlock signal is input:

- 0 : The tool stops along all axes.
- 1 : The setting of bit 4 (XIF) of parameter No. 1002 is used.

	#7	#6	#5	#4	#3	#2	#1	#0
7055								
						ALZ	AF1	ACO

[Data type] Bit

ACO In AI contour control mode:

0 : Automatic corner override and changing both internal and external circular feedrates are disabled. (Current specifications)

1 : Automatic corner override and changing the internal circular feedrate are enabled, and whether to enable changing the external circular feedrate depends on the setting of bit 2 (COV) of parameter No. 1602.

AF1 During one-digit F code feed in AI contour control mode, changing the feedrate by the manual handle is:

0 : Disabled.

1 : Enabled.

ALZ If no reference position has been established and G28 is specified in AI contour control mode:

0 : P/S alarm No. 090 is issued.

1 : AI contour control mode is turned off and the command is executed.

4.52 PARAMETERS OF MANUAL HANDLE FEED, HANDLE INTERRUPTION AND HANDLE FEED IN TOOL AXIAL DIRECTION

	#7	#6	#5	#4	#3	#2	#1	#0
7100				HPF	HCL	IHD	THD	JHD

[Data type] Bit

JHD Manual handle feed in JOG feed mode or incremental feed in the manual handle feed
 0 : Invalid
 1 : Valid

	When JHD:=0		When JHD:=1	
	JOG feed mode	Manual handle feed mode	JOG feed mode	Manual handle feed mode
JOG feed	○	×	○	×
Manual handle feed	×	○	○	○
Incremental feed	×	×	×	○

THD Manual pulse generator in TEACH IN JOG mode
 0 : Invalid
 1 : Valid

IHD The travel increment for manual handle interrupt is:
 0 : Output unit, and acceleration/deceleration after interpolation is disabled.
 1 : Input unit, and acceleration/deceleration after interpolation is enabled.

HCL The clearing of handle interruption amount display by soft key [CAN] operation is:
 0 : Disabled.
 1 : Enabled.

HPF When a manual handle feed exceeding the rapid traverse rate is issued,
 0 : The rate is clamped at the rapid traverse rate, and the handle pulses corresponding to the excess are ignored. (The graduations of the manual pulse generator may not agree with the distance the machine has traveled.)
 1 : The rate is clamped at the rapid traverse rate, and the handle pulses corresponding to the excess are not ignored, but stored in the CNC. (If the rotation of the manual pulse generator is stopped, the machine moves by the distance corresponding to the pulses preserved in the CNC, then stops.)

	#7	#6	#5	#4	#3	#2	#1	#0
7102								HNGx

[Data type] Bit axis

HNGx Axis movement direction for rotation direction of manual pulse generator
 0 : Same in direction
 1 : Reverse in direction

	#7	#6	#5	#4	#3	#2	#1	#0
7103				IBH	HIT	HNT	RHD	

[Data type] Bit

RHD By a reset, the amount of manual handle interruption is:
 0 : Not canceled.
 1 : Canceled.

NOTE

This parameter is valid when bit 2 (IHD) of parameter No. 7100 is set to 1.

HNT The manual handle feed/incremental feed magnification is:
 0 : Multiplied by 1.
 1 : Multiplied by 10.

HIT The manual handle interruption magnification is:
 0 : Multiplied by 1.
 1 : Multiplied by 10.

IBH Manual handle feed for the β servo unit using an I/O link is:
 0 : Disabled.
 1 : Enabled.

	#7	#6	#5	#4	#3	#2	#1	#0
7104			HHI					
			HHI	3D2	3D1	CXC		TLX

[Data type] Bit

TLX When the tool axis direction handle feed function when tool axis direction handle feed is used, this parameter selects a tool axis direction when the rotation axes for the three basic axes in the basic coordinate system are positioned to the machine zero point:
 0 : Z-axis direction
 1 : X-axis direction

CXC Tool axis direction handle feed is performed with:
 0 : 5-axis machine.
 1 : 4-axis machine.

3D1 When handle feed is along (or across) the tool axis, the coordinate of the first rotation axis is:
 0 : Machine coordinate that exists when tool axis direction handle feed (or radial tool axis handle feed) mode is selected, or when a reset occurs.
 1 : Value set in parameter No.7144.

3D2 When handle feed is along (or across) the tool axis, the coordinate of the second rotation axis is:
 0 : Machine coordinate that exists when tool axis direction handle feed (or radial tool axis handle feed) mode is selected, or when a reset occurs.
 1 : Value set in parameter No.7145.

HHI Manual handle interrupt during high-speed machining is:
 0 : Disabled.
 1 : Enabled.

7110	Number of manual pulse generators used
------	--

[Data type] Byte

[Valid data range] 1 or 2 (T series), 3 (M series)

This parameter sets the number of manual pulse generators.

7113	Manual handle feed magnification m
------	------------------------------------

[Data type] Word

[Unit of data] One time

[Valid data range] 1 to 127

This parameter sets the magnification when manual handle feed movement selection signal MP2 is set to 1.

7114	Manual handle feed magnification n
------	------------------------------------

[Data type] Word

[Unit of data] One time

[Valid data range] 1 to 1000

This parameter sets the magnification when manual handle feed movement selection signals MP1 and MP2 are set to 1.

Movement selection signal		Movement (Manual handle feed)
MP2	MP1	
0	0	Least input increment × 1
0	1	Least input increment × 10
1	0	Least input increment × m
1	1	Least input increment × n

7117	Allowable number of pulses that can be accumulated during manual handle feed
------	--

[Data type] 2-Word

[Unit of data] Pulses

[Valid data range] 0 to 99999999

If manual handle feed is specified such that the rapid traverse rate will be exceeded momentarily, those pulses received from the manual pulse generator that exceed the rapid traverse rate are accumulated rather than canceled. This parameter sets the maximum number of pulses which can be accumulated in such a case.

NOTE

If the specification of manual handle feed is such that the rapid traverse rate will be exceeded, for example, when the manual pulse generator is rotated at high speed with a large magnification such as $\times 100$, the axial feedrate is clamped at the rapid traverse rate and those pulses received from the manual pulse generator that exceed the rapid traverse rate are ignored. In such a case, therefore, the scale on the manual pulse generator may differ from the actual amount of travel. If such a difference is not acceptable, this parameter can be set to temporarily accumulate the excess pulses in the CNC, rather than ignoring them, up to the specified maximum (pulses in excess of the set maximum are ignored). The accumulated pulses are output and converted to a move command once the feedrate falls below the rapid traverse rate by reducing the rotational speed of the manual pulse generator or stopping its rotation altogether. Note, however, that if the maximum number of pulses to be accumulated is too large, stopping the rotation of the manual pulse generator does not stop feeding until the tool moves by an amount corresponding to the pulses accumulated in the CNC.

7120

Axis configuration for using the tool axis direction handle feed when tool axis direction handle feed function

[Data type] Byte

[Valid data range] 1 to 4

When using the tool axis direction handle feed function, suppose that the rotation axes for the three basic axes X, Y, and Z in the basic coordinate system are axes A, B, and C, respectively. Suppose also that the Z-axis represents the tool axis direction when the rotation axes are positioned to the machine zero point. Then, depending on the axis configuration of the machine, four types are available. For a 4-axis machine, types (1) and (2) are available.

- (1) A-C axis type
- (2) B-C axis type
- (3) A-B axis (A-axis master) type
- (4) A-B axis (B-axis master) type

This parameter selects a type. Values of 1 to 4 are assigned to these types, in order, from top to bottom. When the X-axis represents the tool axis direction, the above types are changed to B-A axis type, C-A axis type, B-C axis (B-axis master) type, and B-C axis (C-axis master) type.

7121	
	Axis selection in tool axis direction handle feed mode

[Data type] Byte

[Valid data range] 1 to number of controlled axes

This parameter sets an axis number for the manual handle feed axis selection signal for the first manual pulse generator to enable tool axis direction handle feed mode. When the value set in this parameter matches the value of the manual handle feed axis selection signal, tool axis direction handle feed mode is enabled.

7141	
	Axis selection in the X direction for the radial tool axis handle feed

7142	
	Axis selection in the Y direction for the radial tool axis handle feed

[Data type] Byte

[Valid data range] 1 to 8

These parameters specify the axis selection signal for the first manual pulse generator used to enable the radial tool axis handle feed. When the setting of these parameters matches the manual handle feed axis selection signal, radial tool axis handle feed mode is enabled.

7144	
	Coordinate of the first rotation axis for tool axis direction handle feed and radial tool axis handle feed

7145	
	Coordinate of the second rotation axis for tool axis handle feed and radial tool axis handle feed

[Data type] 2-word

[Unit of data] 0.001 degrees

[Valid data range] -360000 to 360000

These parameters specify the coordinates (rotation degrees) of the first and second rotation axes used when parameters 3D1 and 3D2 (bits 3 and 4 of parameter No.7104) are 1. When parameter CXC (bit 2 of parameter No.7104) is 1, however, the coordinate of the second rotation axis is assumed to be 0 regardless of the value of 3D2 or this parameter.

4.53 PARAMETERS OF MANUAL LINE AND ARC FUNCTIONS

7160

Approach handle clamp feedrate

[Data type] 2-word

[Unit of data, Valid data range]

Increment system	Unit of data	Valid data range	
		IS-A, IS-B	IS-C
Metric machine	1 mm/min	0 to 15000	0 to 12000
Inch machine	0.1 inch/min	0 to 6000	0 to 4800
Rotation axis	1 deg/min	0 to 15000	0 to 12000

When the setting is 0, the feedrate is not clamped.

7161

Guidance handle clamp feedrate

[Data type] 2-word

[Unit of data, Valid data range]

Increment system	Unit of data	Valid data range	
		IS-A, IS-B	IS-C
Metric machine	1 mm/min	0 to 15000	0 to 12000
Inch machine	0.1 inch/min	0 to 6000	0 to 4800
Rotation axis	1 deg/min	0 to 15000	0 to 12000

When the setting is 0, the feedrate is not clamped.

4.54 PARAMETERS OF REFERENCE POSITION SETTING WITH MECHANICAL STOPPER

7181

First withdrawal distance in reference position setting with mechanical stopper

[Data type] 2-word axis

[Unit of data]

Increment system	IS-A	IS-B	IS-C	Unit
Millimeter machine	0.01	0.001	0.0001	mm
Inch machine	0.001	0.0001	0.00001	inch

[Valid data range] -99999999 to 99999999

When the reference position setting with mechanical stopper is used, this parameter sets a distance an axis, along which withdrawal is performed after the mechanical stopper is hit (distance from the mechanical stopper to the withdrawal point).

NOTE

Set the same direction as that set in bit 5 (ZMIx) of parameter No. 1006. Cycle operation cannot be started if the opposite direction is set.

7182

Second withdrawal distance in reference position setting with mechanical stopper

[Data type] 2-word axis

[Unit of data]

Increment system	IS-A	IS-B	IS-C	Unit
Millimeter machine	0.01	0.001	0.0001	mm
Inch machine	0.001	0.0001	0.00001	inch

[Valid data range] -99999999 to 99999999

When the reference position setting with mechanical stopper is used, this parameter sets a distance an axis, along which withdrawal is performed after the mechanical stopper is hit (distance from the mechanical stopper to the withdrawal point).

NOTE

Set the same direction as that set in bit 5 (ZMIx) of parameter No. 1006. Cycle operation cannot be started if the opposite direction is set.

7183

First butting feedrate in reference position setting with mechanical stopper

[Data type] Word axis**[Unit of data and valid range]**

Increment system	Unit of data	Valid data range	
		IS-A, IS-B	IS-C
Millimeter machine	1 mm/min	30 to 15000	30 to 12000
Inch machine	0.1 inch/min	30 to 6000	30 to 4800

When the reference position setting with mechanical stopper is used, this parameter sets the feedrate first used to hit the stopper on an axis.

7184

Second butting feedrate in reference position setting with mechanical stopper

[Data type] Word axis**[Unit of data and valid range]**

Increment system	Unit of data	Valid data range	
		IS-A, IS-B	IS-C
Millimeter machine	1 mm/min	30 to 15000	30 to 12000
Inch machine	0.1 inch/min	30 to 6000	30 to 4800

When the reference position setting with mechanical stopper is used, this parameter sets the feedrate used to hit the stopper on an axis for a second time.

7185

Withdrawal feedrate (common to the first and second butting operations) in reference position setting with mechanical stopper

[Data type] Word axis**[Unit of data and valid range]**

Increment system	Unit of data	Valid data range	
		IS-A, IS-B	IS-C
Millimeter machine	1 mm/min	30 to 15000	30 to 12000
Inch machine	0.1 inch/min	30 to 6000	30 to 4800

When the reference position setting with mechanical stopper is used, this parameter sets the feedrate used for withdrawal along an axis after the mechanical stopper has been hit.

7186

Torque limit value in reference position setting with mechanical stopper

[Data type] Byte axes**[Unit of data]** %**[Valid data range]** 0 to 100

This parameter sets a torque limit value in reference position setting with mechanical stopper

NOTE

When 0 is set in this parameter, 100% is assumed.

4.55 PARAMETERS OF SOFTWARE OPERATOR'S PANEL

	#7	#6	#5	#4	#3	#2	#1	#0
7200		OP7	OP6	OP5	OP4	OP3	OP2	OP1

[Data type] Bit

- OP1** Mode selection on software operator's panel
0 : Not performed
1 : Performed
- OP2** JOG feed axis select and JOG rapid traverse buttons on software operator's panel
0 : Not performed
1 : Performed
- OP3** Manual pulse generator's axis select and manual pulse generator's magnification switches on software operator's panel
0 : Not performed
1 : Performed
- OP4** JOG speed override and rapid traverse override switches on software operator's panel
0 : Not performed
1 : Performed
- OP5** Optional block skip, single block, machine lock, and dry run switches on software operator's panel
0 : Not performed
1 : Performed
- OP6** Protect key on software operator's panel
0 : Not performed
1 : Performed
- OP7** Feed hold on software operator's panel
0 : Not performed
1 : Performed

	#7	#6	#5	#4	#3	#2	#1	#0
7201								JPC

[Data type] Bit

- JPC** For the name of a general-purpose switch function on the software operator's panel, the use of full-size characters is:
0 : Not allowed.
1 : Allowed.

7210	Job-movement axis and its direction on software operator's panel [↑]
7211	Job-movement axis and its direction on software operator's panel [↓]
7212	Job-movement axis and its direction on software operator's panel [→]
7213	Job-movement axis and its direction on software operator's panel [←]
7214	Job-movement axis and its direction on software operator's panel [↗]
7215	Job-movement axis and its direction on software operator's panel [↖]
7216	Job-movement axis and its direction on software operator's panel [↘]
7217	Job-movement axis and its direction on software operator's panel [↙]

[Data type] Byte

[Valid data range] 0 to 8

On software operator's panel, set a feed axis corresponding to an arrow key on the MDI panel when jog feed is performed.

Set value	Feed axis and direction
0	Not moved
1	First axis, positive direction
2	First axis, negative direction
3	Second axis, positive direction
4	Second axis, negative direction
5	Third axis, positive direction
6	Third axis, negative direction
7	Fourth axis, positive direction
8	Fourth axis, negative direction

Arrow keys on the MDI panel

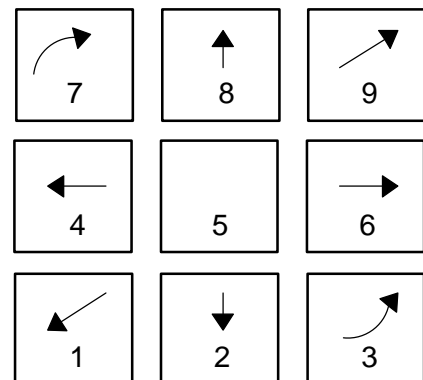

Example

Under X, Y, and Z axis configuration, to set arrow keys to feed the axes in the direction specified as follows, set the parameters to the values given below. [8 ↑] to the positive direction of the Z axis, [2 ↓] to the negative direction of the Z axis, [6 →] to the positive direction of the X axis [4 ←] to the negative direction of the X axis, [1 ↖] to the positive direction of the Y axis, [9 ↗] to the negative direction of the Y axis

Parameter No.7210 = 5 (Z axis, positive direction)

Parameter No.7211 = 6 (Z axis, negative direction)

Parameter No.7212 = 1 (X axis, positive direction)

Parameter No.7213 = 2 (X axis, negative direction)

Parameter No.7214 = 3 (Y axis, positive direction)

Parameter No.7215 = 4 (Y axis, negative direction)

Parameter No.7216 = 0 (Not used)

Parameter No.7217 = 0 (Not used)

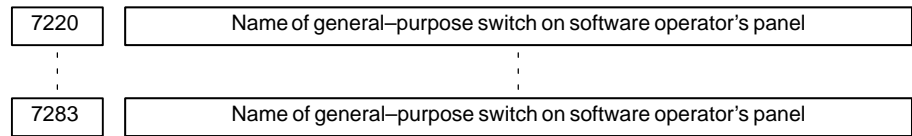

[Data type] Byte

Example

These parameters set the names of the general-purpose switches (SIGNAL 1 through SIGNAL 8) on the software operator's panel as described below.

OPERATOR'S PANEL		O1234	N5678
SIGNAL1	: OFF	ON	
SIGNAL2	: OFF	ON	
SIGNAL3	: OFF	ON	
SIGNAL4	: OFF	ON	
SIGNAL5	: OFF	ON	
SIGNAL6	: OFF	ON	
SIGNAL7	: OFF	ON	
SIGNAL8	: OFF	ON	

These names are set using character codes that are displayed in parameter Nos. 7220 to 7283.

Parameter No.7220:

Sets the character code (083) corresponding to S of SIGNAL 1.

Parameter No.7221:

Sets the character code (073) corresponding to I of SIGNAL 1.

Parameter No.7222:

Sets the character code (071) corresponding to G of SIGNAL 1.

Parameter No.7223:

Sets the character code (078) corresponding to N of SIGNAL 1.

Parameter No.7224:

Sets the character code (065) corresponding to A of SIGNAL 1.

Parameter No.7225:

Sets the character code (076) corresponding to L of SIGNAL 1.

Parameter No.7226:

Sets the character code (032) corresponding to (space) of SIGNAL 1.

Parameter No.7227:

Sets the character code (049) corresponding to 1 of SIGNAL 1.

Parameter Nos. 7228 to 7235:

Set the character codes of SIGNAL 2 shown in the figure above.

Parameter Nos. 7236 to 7243:

Set the character codes of SIGNAL 3 shown in the figure above.

Parameter Nos. 7244 to 7251:

Set the character codes of SIGNAL 4 shown in the figure above.

Parameter Nos. 7252 to 7259:

Set the character codes of SIGNAL 5 shown in the figure above.

Parameter Nos. 7260 to 7267:

Set the character codes of SIGNAL 6 shown in the figure above.

Parameter Nos. 7268 to 7275:

Set the character codes of SIGNAL 7 shown in the figure above.

Parameter Nos. 7276 to 7283:

Set the character codes of SIGNAL 8 shown in the figure above.

The character codes are shown in Appendix A CHARACTER CODE LIST.

7284	Name of general-purpose switch on software operator's panel (extended)
7285	Name of general-purpose switch on software operator's panel (extended)
7286	Name of general-purpose switch on software operator's panel (extended)
:	:
7299	Name of general-purpose switch on software operator's panel (extended)
7352	Name of general-purpose switch on software operator's panel (extended)
7353	Name of general-purpose switch on software operator's panel (extended)
7354	Name of general-purpose switch on software operator's panel (extended)
:	:
7399	Name of general-purpose switch on software operator's panel (extended)

[Data type] Byte

Set the names of the general-purpose switches (SIGNAL 9 to SIGNAL 16) on the software operator's panel, as described below.

OPERATOR'S PANEL		O1234 N5678	
SIGNAL1	:	OFF	ON
SIGNAL2	:	OFF	ON
SIGNAL3	:	OFF	ON
SIGNAL4	:	OFF	ON
SIGNAL5	:	OFF	ON
SIGNAL6	:	OFF	ON
SIGNAL7	:	OFF	ON
SIGNAL8	:	OFF	ON

These names are set using the character codes displayed in parameters No.7284 through No.7299, and parameters No.7352 through No.7399.

Parameter No.7284:

Set the character code (083) corresponding to S of SIGNAL 9.

Parameter No.7285:

Set the character code (073) corresponding to I of SIGNAL 9.

Parameter No.7286:

Set the character code (071) corresponding to G of SIGNAL 9.

Parameter No.7287:

Set the character code (078) corresponding to N of SIGNAL 9.

Parameter No.7288:

Set the character code (065) corresponding to A of SIGNAL 9.

Parameter No.7289:

Set the character code (076) corresponding to L of SIGNAL 9.

Parameter No.7290:

Set the character code (032) corresponding to (space) of SIGNAL 9.

Parameter No.7291:

Set the character code (057) corresponding to 9 of SIGNAL 9.

Similarly, set character codes as shown below.

Parameter No.7292 to No.7299: Set character codes for SIGNAL 10, shown above.

Parameter No.7352 to No.7359: Set character codes for SIGNAL 11, shown above.

Parameter No.7360 to No.7367: Set character codes for SIGNAL 12, shown above.

Parameter No.7368 to No.7375: Set character codes for SIGNAL 13, shown above.

Parameter No.7376 to No.7383: Set character codes for SIGNAL 14, shown above.

Parameter No.7384 to No.7391: Set character codes for SIGNAL 15, shown above.

Parameter No.7392 to No.7399: Set character codes for SIGNAL 16, shown above.

The character codes are shown in the character code correspondence table in Appendix A.

4.56 PARAMETERS OF PROGRAM RESTART

	#7	#6	#5	#4	#3	#2	#1	#0
7300	MOU	MOA						
	MOU	MOA			SJG			

[Data type] Bit

SJG Return feedrate in program restart operation
 0 : Dry run feedrate
 1 : Jog feedrate

MOA In program restart operation, before movement to a machining restart point after restart block search:
 0 : The last M, S, T, and B codes are output.
 1 : All M codes and the last S, T, and B codes are output.

NOTE

This parameter is enabled when the MOU parameter is set to 1.

MOU In program restart operation, before movement to a machining restart point after restart block search:
 0 : The M, S, T, and B codes are not output.
 1 : The last M, S, T, and B codes are output.

7310	Movement sequence to program restart position
------	---

Setting entry is accepted.

[Data type] Byte

[Valid data range] 1 to No.of controlled axes

This parameter sets the axis sequence when the machine moves to the restart point by dry run after a program is restarted.

[Example]

The machine moves to the restart point in the order of the fourth, first, second, and third axes one at a time when the first axis = 2, the second axis = 3, the third axis = 4, and the fourth axis = 1 are set.

4.57 PARAMETERS OF HIGH-SPEED MACHINING (HIGH-SPEED CYCLE MACHINING/HIGH- SPEED REMOTE BUFFER)

	#7	#6	#5	#4	#3	#2	#1	#0
7501	IPC	IT2	IT1	IT0				CSP
	IPC	IT2	IT1	IT0				

[Data type] Bit

CSP Cs contouring control function dedicated to a piston lathe is
0 : Not used.
1 : Used.

IT0, IT1, IT2

IT2	IT1	IT0	Interpolation of G05 data (ms)
0	0	0	8
0	0	1	2
0	1	0	4
0	1	1	1
1	0	0	16

IPC

0 : The system does not monitor whether a distribution process is stopped while high-speed machining (G05) is performed with high-speed remote buffer A or B or in a high-speed cycle.
1 : The system monitors whether a distribution process is stopped while high-speed machining (G05) is performed with high-speed remote buffer A or B or in a high-speed cycle.
(P/S alarms 179 and 000 are simultaneously issued if the distribution process is stopped. In this case, the power must be turned off then on again.)

NOTE

The distribution process stops, when the host cannot send data with the high-speed remotebuffer by the specified time.

	#7	#6	#5	#4	#3	#2	#1	#0
7502			LC2	LC1	L8M		PMX	
			LC2	LC1	L8M		PMX	SUP

[Data type] Bit

SUP In high-speed remote buffering and high-speed machining:
0 : Acceleration/deceleration control is not applied.
1 : Acceleration/deceleration control is applied.

PMX A PMC axis control command in high-speed cycle machining (G05) is:
0 : Ignored.
1 : Executed.

L8M In high-speed cycle machining (G05) with an interpolation period of 8 ms, digital servo learning control is:
 0 : Not applied.
 1 : Applied.

LC1, LC2 The servo learning function of the high-speed cycle machining retract function is enabled or disabled as indicated below.

LC2	LC1	Description
0	0	Disables the servo learning function, after which retract operation starts.
0	1	Disables the servo learning function upon the completion of retract operation.
1	0	Disables the servo learning function upon the completion of a retract cycle.

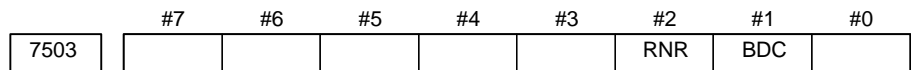

[Data type] Bit

BDC In high-speed binary operation, the deceleration function is:
 0 : Disabled.
 1 : Enabled.

RNR In the reset status after retract operation by the retract function in a high-speed remote buffer:
 0 : The reset signal RST <bit 1 of F0001> is set to 1.
 1 : The reset signal RST <bit 1 of F0001> is set to 0.

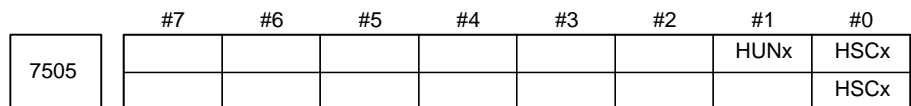

NOTE

After setting this parameter, the power must be tuned off then on again.

[Data type] Bit axis

HSCx Specifies whether each axis is used for high-speed distribution in a high-speed cycle or with a high-speed remote buffer.
 0 : Not used for high-speed distribution.
 1 : Used for high-speed distribution

HUNx Specifies whether the unit of data to be distributed during machining a high-speed cycle is tentimes the least input increment.
 0 : The unit of data is the same as the least input increment.
 1 : The unit of data is ten times the least input increment.

NOTE

This parameter is used when a data item to be distributed exceeds a word in terms of the least input increment or the maximum travel speed.

The data to be distributed for machining in a high-speed cycle for the axes in which this parameter HUNX = 1 is set. Therefore, set a value one tenth the value to be distributed for machining in a high-speed cycle along the specified axes.

7510

Maximum number of simultaneously controlled axes when G05 is specified during high-speed cycle machining/No.of controlled axes in high-speed remote buffer

[Data type] Word

[Valid data range] 1 to 16

This parameter sets the maximum number of simultaneous control axes when G05 is specified during high-speed cycle machining or sets the number of control axes in a high-speed remote buffer.

In addition, this parameter is also used to set the maximum number of simultaneous control axes used during high-speed, high-precision machining controlled by the RISC.

7514

Retract direction and retract feedrate in high-speed cycle machining retract operation

[Data type] 2-word axis

[Units of data], [Valid data range]

Increment system	Units of data	Valid data range	
		IS-A, IS-B	IS-C
Metric input	1mm/min	-30 to -240000 30 to 240000	-30 to -100000 30 to 100000
Inch input	0.1inch/min	-30 to -96000 30 to 96000	-30 to -48000 30 to 48000

This parameter sets a retract direction and retract feedrate along each axis in a high-speed cycle machining retract operation. The retract direction is specified by a sign.

7515

Number of retract operation distributions in a high-speed cycle machining retract operation

[Data type] 2-word

[Unit of data] Number of distributions

[Valid data range] 0 to 99999999

This parameter sets the number of retract operation distributions in a high-speed cycle machining retract operation.

When the cycle currently being executed ends before the number of distributions specified in this parameter are performed, retract operation is terminated. When 0 is specified in this parameter, the number of retract operation distributions is assumed to be infinite. In this case, retract operation is performed until the cycle currently being executed ends.

7521

Retract time constant

[Data type] Word axis**[Unit of data]** m**[Valid data range]** 1 to 4000

This parameter sets the time constant for time-setting linear acceleration/deceleration used in retract operation during high-speed remote buffer operation for each axis. (Time constant for deceleration at stop)

NOTE

The time constant setting is shifted according to the data interpolation period during high-speed remote buffer operation.

- When the interpolation period is 8 ms, a multiple of 8 in ms is used as the time constant.
- When the interpolation period is 4 ms, a multiple of 4 in ms is used as the time constant.
- When the interpolation period is 2 ms, a multiple of 2 in ms is used as the time constant.
- When the interpolation period is less than 1 ms, the unit of the time constant is ms.

When the time constant setting is not a multiple of 8, 4, or 2, it is rounded up to the nearest multiple of 8, 4, or 2.

[Example] When the setting is 9:

- 1) When the interpolation period is 8 ms, the time constant is 16 ms.
- 2) When the interpolation period is 4 ms, the time constant is 12 ms.
- 3) When the interpolation period is 2 ms, the time constant is 10 ms.
- 4) When the interpolation period is less than 1 ms, the time constant is 9 ms.

7522

Retract amount

[Data type] 2-word axis**[Unit of data]**

Increment system	IS-A	IS-B	IS-C	Unit
Linear axis (millimeter input)	0.01	0.001	0.0001	mm
Linear axis (Inch input)	0.001	0.0001	0.00001	inch
Rotation axis	0.01	0.001	0.0001	deg

[Valid data range] -99999999 to 99999999

This parameter sets the amount of travel by retract operation during high-speed remote buffer operation for each axis.

7523

Retractfeedrate

[Data type] 2-word axis

[Unit of data, Valid data range]

Increment system	Unit of data	Valid data range	
		IS-A, IS-B	IS-C
Metric machine	1 mm/min	30 to 240000	30 to 100000
Inch machine	0.1 inch/min	30 to 96000	30 to 48000
Rotation axis	1 deg/min	30 to 240000	30 to 100000

This parameter sets the traverse feedrate in retract operation during high-speed remote buffer operation for each axis.

NOTE

The sum of the feedrate in high-speed remote buffer operation and that set in this parameter is limited according to the interpolation period. If the maximum feedrate listed in the following table is exceeded, P/S alarm No. 179 is issued.

Increment system	Unit of data	Interpolated time	Valid data range	
			IS-A, IS-B	IS-C
Metric machine	1 mm/min	16,8,4 ms	490000	49000
		2 ms	980000	98000
		1 ms	1960000	196000
		0.5 ms	3920000	392000
Inch machine	0.1 inch/min	16,8,4 ms	190000	19000
		2 ms	380000	38000
		1 ms	760000	76000
		0.5 ms	1530000	153000
Rotation axis	1 deg/min	16,8,4 ms	490000	49000
		2 ms	980000	98000
		1 ms	1960000	196000
		0.5 ms	3920000	392000

7524

Reference axis for retraction

[Data type] Byte**[Valid data range]** 0 to 6

In retract operation during high-speed remote buffer operation, when a reference axis passes through a fixed position in cyclic operation, deceleration can be started at the specified timing (position of the reference axis).

Set the number of a reference controlled axis in this parameter and the absolute coordinate position in parameter No. 7523. After the retract signal is input, deceleration starts when the reference axis passes through the specified absolute coordinate position.

0 : Deceleration starts immediately after the retract signal is input.
 1 to 6: Deceleration starts when the specified reference axis passes through the absolute position set in parameter No. 7525.

7525

Absolute coordinate position of the reference axis for retraction

[Data type] 2-word**[Unit of data]**

Increment system	IS-A	IS-B	IS-C	Unit
Linear axis (millimeter input)	0.01	0.001	0.0001	mm
Linear axis (Inch input)	0.001	0.0001	0.00001	inch
Rotation axis	0.01	0.001	0.0001	deg

[Valid data range] -99999999 to 99999999

In retract operation during high-speed remote buffer operation, when a reference axis passes through a fixed position in cyclic operation, deceleration can be started at the specified timing (position of the reference axis).

Set the number of a reference controlled axis in parameter No. 7524 and the absolute coordinate position in this parameter. After the retract signal is input, deceleration starts when the reference axis passes through the specified absolute coordinate position.

This parameter sets the absolute coordinate position.

4.58 PARAMETERS OF ROTARY TABLE DYNAMIC FIXTURE OFFSET

	#7	#6	#5	#4	#3	#2	#1	#0
7570							FK1	FTP

[Data type] Bit

FTP Fixture offset type setting

0 : Movement type

(The tool moves when the fixture offset changes.)

1 : Shift type

(The tool does not move when the fixture offset changes.)

FK1 When bit 7 (KEY) of parameter No. 3290 is set to 0, input of fixture offset data using MDI keys is:

0 : Disabled when signal KEY1 is set to 0 or enabled when the signal is set to 1.

(Same as for the input enable conditions for the tool offset value)

1 : Enabled when signal KEY1 is set to 0 or disabled when the signal is set to 1.

(Inverse of the input enable conditions for the tool offset value)

	#7	#6	#5	#4	#3	#2	#1	#0
7575								FAX

[Data type] Bit axis

FAX Axis-by-axis fixture offset is:

0 : Disabled.

1 : Enabled.

7580	Specification of a rotation axis for fixture offset (first group)
7581	Specification of linear axis 1 used for selecting a plane for fixture offset (first group)
7582	Specification of linear axis 2 used for selecting a plane for fixture offset (first group)
7583	Specification of a rotation axis for fixture offset (second group)
7584	Specification of linear axis 1 used for selecting a plane for fixture offset (second group)
7585	Specification of linear axis 2 used for selecting a plane for fixture offset (second group)
7586	Specification of a rotation axis for fixture offset (third group)

7587	Specification of linear axis 1 used for selecting a plane for fixture offset (third group)
7588	Specification of linear axis 2 used for selecting a plane for fixture offset (third group)

[Data type] Byte

[Valid data range] 1 to Number of controlled axis

These parameters specify rotation axes for fixture offset and pairs of linear axes for selecting a rotation plane. Specify a pair of linear axes so that rotation from the positive direction of linear axis 1 to the positive direction is in the normal direction of the rotation axis.

Up to three groups of a rotation axis setting and two linear axis settings can be specified. The fixture offset value is calculated first for the rotation axis in the first group. Then, for the second and third groups, the fixture value is sequentially calculated using the previous calculation result. When you do not need the third group, set 0 for the rotation axis.

4.59 PARAMETERS OF POLYGON TURNING

	#7	#6	#5	#4	#3	#2	#1	#0
7600	PLZ							

[Data type] Bit

PLZ Synchronous axis using G28 command

- 0: Returns to the reference position in the same sequence as the manual reference position return.
- 1: Returns to the reference position by positioning at a rapid traverse. The synchronous axis returns to the reference position in the same sequence as the manual reference position return when no return-to-reference position is performed after the power is turned on.

	#7	#6	#5	#4	#3	#2	#1	#0
7602			COF	HST	HSL	HDR	SNG	MNG

[Data type] Bit

- MNG** The rotational direction of the master axis in the spindle-spindle polygon turning mode is:
 - 0 : Not reversed.
 - 1 : Reversed.
- SNG** The rotational direction of the polygon synchronization axis in the spindle-spindle polygon turning mode is:
 - 0 : Not reversed.
 - 1 : Reversed.
- HDR** When phase control is exercised in spindle-spindle polygon turning mode (COF = 0), the phase shift direction is:
 - 0 : Not reversed for phase synchronization.
 - 1 : Reversed for phase synchronization.

NOTE

Use MNG, SNG, and HDR when the specified rotational direction of the master axis or polygon synchronization axis, or the specified phase shift direction is to be reversed in spindle-spindle polygon turning mode.

- HSL** When phase control is exercised in spindle-spindle polygon turning mode (COF = 0), this parameter selects the spindle that is subject to a phase shift operation for phase synchronization:
 - 0 : The polygon synchronization axis (second spindle) is selected.
 - 1 : The master axis (first spindle) is selected.
- HST** When phase control is applied in spindle-spindle polygon turning mode (COF = 0), and spindle-spindle polygon turning mode is specified:
 - 0 : Spindle-spindle polygon turning mode is entered with the current spindle speed maintained.
 - 1 : Spindle-spindle polygon turning mode is entered after the spindle is stopped.

NOTE

This parameter can be used, for example, when single-rotation signal detection cannot be guaranteed at an arbitrary feedrate because a separate detector is installed to detect the spindle single-rotation signal, as when a built-in spindle is used. (When bit 7 of parameter No.4016 for the serial spindle is set to 1, together with this parameter, a single-rotation signal detection position in spindle-spindle polygon turning mode is guaranteed.)

COF In spindle-spindle polygon turning mode, phase control is:
 0 : Used.
 1 : Not used.

NOTE

When the use of phase control is not selected, the steady state is reached in a shorter time because phase synchronization control is not applied. Once steady rotation is achieved, however, polygonal turning must be completed without changing the steady state. (If the rotation is stopped, or the rotational speed altered, polygonal turning is disabled because of the inevitable phase shift.) Even when this parameter is set to 1, an R command (phase position command) in a block containing G51.2 is ignored ; no alarm is issued.

	#7	#6	#5	#4	#3	#2	#1	#0
7603	PST		RDG			SBR	QDR	RPL

[Data type] Bit

- RPL** Upon reset, spindle-spindle polygon turning mode is:
 0 : Released.
 1 : Not released.
- QDR** The rotational direction of the polygon synchronization axis:
 0 : Depends on the sign (+/-) of a specified value for Q.
 1 : Depends on the rotational direction of the first spindle. (If - is specified for Q, P/S alarm No.218 is issued.)
- SBR** For spindle synchronization, speed ratio control is:
 0 : Disabled.
 1 : Enabled.

NOTE

The spindle synchronization option is needed. Parameter Nos. 7635 and 7636 also need be set up.

RDG On the diagnosis screen No.476, for spindle-spindle polygon phase command value (R), displays:
 0 : The specified value (in the increment system for the rotation axis).
 1 : The actual number of shift pulses.

NOTE

A phase command is specified in address R, in units of degrees. For control, the actual shift amount is converted to a number of pulses according to the conversion formula: 360 degrees = 4096 pulses. This parameter switches the display of a specified value to that of a converted value.

PST The polygon spindle stop signal *PLSST (bit 0 of G038) is:
 0 : Not used.
 1 : Used.

7610	Control axis number of tool rotation axis for polygon turning

[Data type] Byte

[Valid data range] 1, 2, 3, . . . number of control axes

This parameter sets the control axis number of a rotation tool axis used for polygon turning.

7620	Movement of tool rotation axis per revolution

[Data type] 2-word

Increment system	IS-A	IS-B	IS-C	Unit
Rotation axis	0.01	0.001	0.0001	deg

[Valid data range] 1 to 9999999

This parameter sets the movement of a tool rotation axis per revolution.

7621	Maximum allowable speed for the tool rotation axis (polygon synchronization axis)

[Data type] Word

[Unit of data] rpm

[Valid data range] For polygonal turning using servo motors:

$$0 \text{ to } 1.2 \times 10^8$$

set value of the parameter No.7620

For polygon turning with two spindles:

Set a value between 0 and 32767, but which does not exceed the maximum allowable speed, as determined by the performance of the second spindle and other mechanical factors.

This parameter sets the maximum allowable speed of the tool rotation axis (polygon synchronization axis).

If the speed of the tool rotation axis (polygon synchronization axis) exceeds the specified maximum allowable speed during polygon turning, the speed is clamped at the maximum allowable speed. When the speed is clamped at a maximum allowable speed, however, synchronization between the spindle and tool rotation axis (polygon synchronization axis) is lost. And, when the speed is clamped, P/S alarm No.5018 is issued.

7631	Allowable spindle speed deviation level in spindle–spindle polygon turning

[Data type] Byte

[Unit of data] min^{-1}

[Valid data range] 0 to 255

[Standard setting value] 1 to 10

This parameter sets the allowable level of deviation between the actual speed and specified speed of each spindle in spindle–spindle polygon turning. The value set with this parameter is used for both the master axis and polygon synchronization axis.

7632	Steady state confirmation time duration in spindle polygon turning

[Data type] Word

[Unit of data] ms

[Valid data range] 0 to 32767

This parameter sets the duration required to confirm that both spindles have reached their specified speeds in spindle–spindle polygon turning. If the state where the speed of each spindle is within the range set with parameter No.7631, and has lasted at least for the duration specified with parameter No.7632, the spindle polygon speed arrival signal PSAR (bit 2 of F0063) is set to 1.

7635	Multiplier influencing the slave spindle speed

[Data type] Byte

[Unit of data] Slave spindle (min^{-1})/master spindle (min^{-1})

[Valid data range] 1 to 9

Set up a multiplier that will act on the distance through which the slave spindle is to move.

In speed ratio control, the relationship between the speeds of the spindles is:

(Slave spindle speed) = (master spindle speed) \times (setting of parameter No. 7635)

NOTE

The spindle synchronization option is needed.
It is valid when parameter SBR (bit 2 of parameter No. 7603) = 1.

7636	Upper limit of the slave spindle speed

[Data type] Word

[Unit of data] min^{-1}

[Valid data range] 1 to 19999

Specify a clamp speed for the slave spindle. If the slave spindle speed calculated from the master spindle speed exceeds the specified slave spindle clamp speed, the actual slave spindle speed is clamped at this clamp speed. At the same time, the master spindle speed is decreased to maintain a constant spindle rotation ratio.

NOTE

The spindle synchronization option is needed.
It is valid when parameter SBR (bit 2 of parameter No. 7603) = 1.

7640	Master axis in spindle–spindle polygon turning

7641	Slave axis in spindle–spindle polygon turning

[Data type] Byte

[Valid data range] 0, 1 to Number of spindles

These parameters set the master and slave axes in spindle–spindle polygon turning.

- Settings
- 1 : First spindle
 - 2 : Second spindle
 - 3 : Third spindle
 - 4 : Fourth spindle (only for the Series 16i)

NOTE

- 1 Spindle–spindle polygon turning is enabled only for serial spindles.
- 2 If the setting of either parameter is “0”, polygon turning is performed for the first and second spindles.

Any spindle in another path cannot be specified.

4.60 PARAMETERS OF THE EXTERNAL PULSE INPUT

7681	
	Setting 1 for the ratio of an axis shift amount to external pulses (M)

[Data type] Word

[Valid data range] 1 to 255

7682	
	Setting 2 for the ratio of an axis shift amount to external pulses (N)

[Data type] Word

[Valid data range] 1 to 1000

4.61 PARAMETERS OF THE HOBBING MACHINE AND SIMPLE ELECTRIC GEAR BOX (EGB)

	#7	#6	#5	#4	#3	#2	#1	#0
7700		DPS	RTO		MLT	HDR	CMS	HBR

[Data type] Bit

- HBR** 0 : Performing a reset cancels synchronization of the C-axis to the hob axis (G81).
1 : Performing a reset does not cancel synchronization of the C-axis to the hob axis (G81).
- CMS** 0 : The position manually set with a single rotation signal is canceled when a synchronization cancel command (G80, reset) is issued.
1 : The position manually set with a single rotation signal is not canceled when a synchronization cancel command (G80, reset) is issued.
- HDR** Setting of the direction for compensating a helical gear (1 is usually specified.)
- MLT** Unit of data for the magnification for compensating C-axis servo delay (parameter No.7714)
0 : 0.001
1 : 0.0001
- RTO** Gear ratio for the spindle and position coder specified in parameter No.3706
0 : Disabled (Always specify 0.)
1 : Enabled
- DPS** Display of actual spindle speed
0 : The hob-axis speed is displayed.
1 : The spindle speed is displayed.

	#7	#6	#5	#4	#3	#2	#1	#0
7701			DLY	JHD	LZE	SM3	SM2	SM1

[Data type] Bit

SM1, SM2, SM3

Specify the number of times a feedback pulse from the position coder is sampled when the hobbing machine function is used.

SM3	SM2	SM1	Number of times the pulse is sampled
0	0	0	4
0	0	1	1
0	1	0	2
0	1	1	16
1	0	0	32
1	1	0	4
1	1	1	4

- LZE** If L (number of hob threads) = 0 is specified at the start of EGB synchronization:
 0 : Synchronization is started, assuming that L = 1 is specified.
 1 : Synchronization is not started, assuming that L = 0 is specified.
 However, helical gear compensation is performed.
- JHD** While the C-axis and hob axis are synchronized with each other (in the G81 mode), jogging and handle feeds around the C-axis are
 0 : Disabled
 1 : Enabled
- DLY** Compensating C-axis servo delay with G84 is
 0 : Disabled
 1 : Enabled

	#7	#6	#5	#4	#3	#2	#1	#0
7702								
	PHD	PHS			ART			TDP

[Data type] Bit

- TDP** The specifiable number of teeth, T, of the simple electronic gearbox is:
 0 : 1 to 1000
 1 : 0.1 to 100 (1/10 of a specified value).

NOTE

In either case, a value from 1 to 1000 can be specified.

- ART** The retract function executed when an alarm is issued is:
 0 : Disabled.
 1 : Enabled.

When an alarm is issued, the tool is retracted at the specified feedrate by the specified amount of travel.
 (Parameters Nos. 7750 and 7751)

NOTE

If a servo alarm is issued for an axis along which the tool is not retracted, servo motor activation is kept until completion of retraction.

- PHS** When the G81/G80 block contains no R command:
 0 : Acceleration/deceleration is not performed at EGB synchronization start/cancellation.
 1 : Acceleration/deceleration is performed at EGB synchronization start/cancellation. After acceleration/deceleration at synchronization start, phase synchronization is automatically performed.
- PHD** Direction of movement for automatic EGB phase synchronization
 0 : Positive (+) direction
 1 : Negative (-) direction

	#7	#6	#5	#4	#3	#2	#1	#0
7703								
								ERV

[Data type] Bit

ERV During EGB synchronization, feed per revolution is performed:
 0 : For feedback pulses.
 1 : For pulses converted to the feedrate for the workpiece axis.

7709	
	Number of the axial feed axis for a helical gear

[Data type] Byte

[Valid range] 1 to the maximum number of controlled axes

This parameter sets the number of the axial feed axis for a helical gear. If the value out of the valid range is specified, 3 (the 3rd axis) is specified.

NOTE
 After setting this parameter, the power must be turned off then on again.

7710	
	Number of the axis synchronized with the hob axis

NOTE
 When this parameter is set, the power must be turned off before operation is continued.

[Data type] Byte

[Valid range] 1 to the maximum number of controlled axes

This parameter sets the number of the axis (workpiece) that is synchronized with the hob axis (cutter). If a value out of the valid range is specified, 4 (the 4th axis) is assumed.

7711	
	Gear ratio for the hob axis and position coder

[Data type] Byte

[Unit of data] 1 time

[Valid range] 1 to 20

This parameter sets the gear ratio for the hob axis and position coder.

7712	
	Time constant for C-axis acceleration/deceleration during rotation with the hob axis and C-axis synchronized with each other

[Data type] Word

[Unit of data] ms

[Valid range] 0 to 4000

This parameter sets the time constant for C-axis exponential acceleration/deceleration during rotation with the hob axis and C-axis synchronized with each other.

NOTE

Acceleration/deceleration is applied to G01, G83, or compensation of a helical gear with the time constant and FL speed for acceleration/deceleration during cutting feed (parameters 1622 and 1623).

7713	
	FL speed of C-axis acceleration/deceleration during rotation with the hob axis and C-axis synchronized each other

[Data type] Word

[Unit of data and valid range]

Unit of data	Valid range	
	IS-B	IS-C
1 deg/min	6 to 15000	6 to 12000

This parameter sets the FL speed of C-axis exponential acceleration/deceleration during rotation with the hob axis and C-axis synchronized with each other.

7714	
	Magnification2 for compensation of C-axis servo delay by G83

[Data type] Word

[Unit of data] 0.0001/0.001

[Valid range] 500 to 2000

This parameter sets the magnification for compensation of C-axis servo delay by G83.

7715	
	Magnification1 for compensation of C-axis servo delay by G83

[Data type] Word

[Unit of data] 0.0001/0.001

[Valid range] 500 to 2000

This parameter sets the magnification for compensation of C-axis servo delay by G83.

	#7	#6	#5	#4	#3	#2	#1	#0
7730								
								RTRx

[Data type] Bit axis

RTRx Specifies whether the retraction function is effective for each axis.
 0 : Retraction is disabled.
 1 : Retraction is enabled.

7740	Feedrate during retraction for each axis
------	--

[Data type] 2-word axis

[Unit of data and valid range]

Increment system	Unit of data	Valid range	
		IS-B	IS-C
Millimeter machine	1 mm/min	30 to 240000	30 to 100000
Inch machine	0.1 inch/min	30 to 96000	30 to 48000

This parameter sets the feedrate during retraction for each axis.

7741	Retracted distance for each axis
------	----------------------------------

[Data type] 2-word axis

Increment system	Unit of data	
	IS-B	IS-C
Millimeter input	0.001 mm	0.0001 mm
Inch input	0.0001 inch	0.00001 inch

[Valid range] -99999999 to 99999999

This parameter sets the retracted distance for each axis.

7750	
	Feedrate during retraction performed when an alarm is issued

[Data type] 2-word axis

[Unit of data, Valid data range]

Increment system	Unit of data	Valid data range	
		IS-B	IS-C
Millimeter machine	1 mm/min	30 to 240000	30 to 100000
Inch machine	0.1 inch/min	30 to 96000	30 to 48000

This parameter sets the feedrate during retraction performed when an alarm is issued. Whether to perform the retraction depends on the setting of bit 3 (ART) of parameter No. 7702.

7751	
	Amount of retraction performed when an alarm is issued

[Data type] 2-word axis

[Unit of data]

Increment system	Unit of data	
	IS-B	IS-C
Metric input	0.001 mm	0.0001 mm
Inch input	0.0001 inch	0.00001 inch

[Valid data range] -99999999 to 99999999

This parameter sets the amount of retraction performed when an alarm is issued. Whether to perform the retraction depends on the setting of bit 3 (ART) of parameter No. 7702.

7771	
	Number of EGB axis

NOTE

After setting this parameter, turn off the power. Then, turn the power back on to enable the setting.

[Data type] Byte

[Valid data range] 1 to the number of controlled axes

This parameter specifies the number of the EGB axis.

NOTE

- 1 You cannot specify four because the fourth axis is used as the workpiece axis.
- 2 Can not set same number that is used as the workpiece axis.

7772	
	Number of position detector pulses per rotation about tool axis

[Data type] 2-word

[Data unit] Detection unit

[Valid data range] 1 to 99999999

This parameter specifies the number of pulses per rotation about the tool axis (on the spindle side), for the position detector.

NOTE

Specify the number of feedback pulses per rotation about the tool axis for the position detector, considering the gear ratio with respect to the position coder.

7773	
	Number of position detector pulses per rotation about workpiece axis

[Data type] 2–word

[Data unit] Detection unit

[Valid data range] 1 to 99999999

This parameter specifies the number of pulses per rotation about the workpiece axis (on the fourth axis side), for the position detector.

[Example]

The number of feedback pulses for the position detector is 360000 for a rotation axis for which the detection unit is 0.001 deg.

7776	
	Feedrate during automatic phase synchronization for the workpiece axis by the automatic EGB phase synchronization function

[Data type] 2–word

[Unit of data, Valid data range]

Increment system	Unit of data	Valid data range	
		IS-B	IS-C
Rotation axis	1 deg/min	30 to 240000	6 to 100000

This parameter sets the feedrate during automatic phase synchronization for the workpiece axis by the automatic EGB phase synchronization function.

7777	
	Angle shifted from the spindle position (one–rotation signal position) the workpiece axis uses as the reference of phase synchronization by the automatic EGB phase synchronization function

[Data type] 2–word

[Unit of data]

Increment system	IS-B	IS-C	Unit
Rotation axis	0.001	0.0001	deg

[Valid data range] 0 to 3600000

This parameter sets the angle shifted from the spindle position (one–rotation signal position) the workpiece axis uses as the reference of phase synchronization by the automatic EGB phase synchronization function.

4.62 PARAMETERS OF ATTITUDE CONTROL

	#7	#6	#5	#4	#3	#2	#1	#0
7941				RNC	MIA		ATT	INT

[Data type] Bit

INT Interaction control is:

0 : Enabled.

1 : Disabled.

ATT Attitude control is:

0 : Enabled.

1 : Disabled.

MIA When attitude control B is used, G53 (machine coordinate system selection) operation is placed in:

0 : Tip fix mode.

1 : Independent axis mode.

RNC According to a rotation made on the α axis and β axis in manual reference position return operation, the X, Y, and Z coordinates (absolute) and relative coordinates are:

0 : Updated.

1 : Not updated.

	#7	#6	#5	#4	#3	#2	#1	#0
7942							PA5	PA4

[Data type] Bit

PA4 This parameter must be set when rotation about the α axis is performed:

0 : In the same direction as that of the basic attitude.

1 : In the direction opposite to that of the basic attitude.

PA5 This parameter must be set when rotation about the β axis is performed:

0 : In the same direction as that of the basic attitude.

1 : In the direction opposite to that of the basic attitude.

	#7	#6	#5	#4	#3	#2	#1	#0
7943								TGC

[Data type] Bit

TGC Interaction control on the α axis is exercised:

0 : With the polarity opposite to that of the β axis command.

1 : With the same polarity as that of the β axis command.

7950	
	α axis machine zero-degree point offset
7951	
	β axis machine zero-degree point offset

[Data type] 2-word

[Unit of data] 0.001 deg

[Valid data range] 0 to 360000 (Standard setting = 0)

These parameters set machine zero-degree point offset values for the α axis and β axis.

NOTE

Never set a value other than 0, 90000, 180000, or 270000.

7952	
	Upper limit on α axis machining speed
7953	
	Upper limit on β axis machining speed

[Data type] 2-word

[Unit of data] deg/min

[Valid data range] 6 to 15000

These parameters set the upper limits on the α axis and β axis machining speeds.

If the α axis or β axis speeds are greater than the values set in these parameters when attitude control is exercised in sync with move commands for the X-axis, Y-axis, and Z-axis, movement along the X-axis, Y-axis, and Z-axis is performed at feedrates determined from the α axis or β axis speeds, clamped to the specified upper limits.

When using interaction control, set the same value for the α axis or β axis.

7954	
	Length of the first arm
7955	
	Length of the second arm

[Data type] 2-word

[Unit of data] deg/min

[Valid data range] 0 to 500000

These parameters set the lengths of the first and second arms.

When using attitude control A (zero offset type nozzle), set 0 for these parameters.

7956	Number of α -axis interaction gears
7957	Number of β -axis interaction gears

[Data type] Byte

[Valid data range] 0 to 127

When the actual number of gears exceeds the valid data range, set the values obtained by dividing the number of α axis gears and the number of β axis gears by the greatest common measure of the two numbers.

Example: When the number of α axis gears is 300, and the number of β axis gears is 200

Set 3 for parameter No.7956, and 2 for parameter No.7957 because $300:200 = 3:2$.

From the number of α axis interaction gears and the number of β axis interaction gears, a β axis synchronous rotation compensation value is calculated, and a command based on the calculated value is automatically sent for the β axis.

$$\beta \text{ axis synchronous rotation compensation value} = \frac{(\alpha \text{ axis rotation amount}) \times (\text{number of } \beta \text{ axis synchronous rotation gears})}{(\text{number of } \alpha \text{ axis synchronous rotation gears})}$$

4.63 PARAMETERS OF AXIS CONTROL BY PMC

	#7	#6	#5	#4	#3	#2	#1	#0
8001	SKE	AUX	NCC		RDE	OVE		MLE

[Data type] Bit

MLE Whether all axis machine lock signal MLK is valid for PMC-controlled axes

0 : Valid

1 : Invalid

NOTE

Each-axis machine lock signals MLK1 to MLK8 are always valid, regardless of the setting of this parameter.

OVE Signals related to dry run and override used in PMC axis control

0: Same signals as those used for the CNC

(1) Feedrate override signals *FV0 to *FV7

(2) Override cancellation signal OVC

(3) Rapid traverse override signals ROV1 and ROV2

(4) Dry run signal DRN

(5) Rapid traverse selection signal RT

1: Signals specific to the PMC

(1) Feedrate override signals *FV0E to *FV7E

(2) Override cancellation signal OVCE

(3) Rapid traverse override signals ROV1E and ROV2E

(4) Dry run signal DRNE

(5) Rapid traverse selection signal RTE

RDE Whether dry run is valid for rapid traverse in PMC axis control

0 : Invalid

1 : Valid

NCC When a travel command is issued for a PMC-controlled axis (selected by a controlled-axis selection signal) according to the program:

0 : P/S alarm 139 is issued while the PMC controls the axis with an axis control command. While the PMC does not control the axis, a CNC command is enabled.

1 : P/S alarm 139 is issued unconditionally.

AUX The number of bytes for the code of an auxiliary function (12H) command to be output is

0 : 1 (0 to 255)

1 : 2 (0 to 65535)

SKE Skip signal during axis control by the PMC

0 : Uses the same signal SKIP (X004#7) as CNC.

1 : Uses dedicated axis control signal ESKIP (X004#6) used by the PMC.

NOTE

When SKE parameter is set to 1, this signal is valid at the side of 1st path in 2 path control. The SKIP <X013#7> signal is used the same signal as CNC at the side of 2nd path.

	#7	#6	#5	#4	#3	#2	#1	#0
8002	FR2	FR1	PF2	PF1	F10	SUE	DWE	RPD

[Data type] Bit

- RPD** Rapid traverse rate for PMC-controlled axes
 0 : Feedrate specified with parameter No.1420
 1 : Feedrate specified with the feedrate data in an axis control command
- DWE** Minimum time which can be specified in a dwell command in PMC axis control when the increment system is IS-C
 0 : 1 ms
 1 : 0.1 ms
- SUE** Whether acceleration/deceleration is performed for an axis that is synchronized with external pulses, for external pulse synchronization commands in PMC axis control
 0 : Performed (exponential acceleration/deceleration)
 1 : Not performed
- F10** Least increment for the feedrate for cutting feed (per minute) in PMC axis control

F10	Millimeter input	Inch input
0	1 mm/min	0.01 inch/min
1	10 mm/min	0.1 inch/min

- PF1, PF2** Set the the feedrate unit of feed per minute in PMC axis control

PF2	PF1	Feedrate unit
0	0	1/1
0	1	1/10
1	0	1/100
1	1	1/1000

- FR1, FR2** Set the feedrate unit for feed per rotation for an axis controlled by the PMC.

FR2	FR1	Millimeter input	Inch input
0	0	0.0001 mm/rev	0.000001 inch/rev
1	1		
0	1	0.001 mm/rev	0.00001 inch/rev
1	0	0.01 mm/rev	0.0001 inch/rev

	#7	#6	#5	#4	#3	#2	#1	#0
8003							PAX	PIM

NOTE
When this parameter is set, the power must be turned off before operation is continued.

[Data type] Bit

PIM Specifies whether to cause an inch/metric input to affect the linear axis that is subjected only to PMC axis control, as follows:

- 0: To affect.
- 1: Not to affect.

PAX When the number of CNC-controlled axes (parameter No. 1010) is set to 0:

- 0 : All axes are assumed to be CNC axes.
- 1 : All axes are assumed to be PMC axes.

	#7	#6	#5	#4	#3	#2	#1	#0
8004	NDI	NCI	DSL			JFM	NMT	CMV
	NDI	NCI	DSL	G8R	G8C	JFM	NMT	CMV

CMV When a move command and auxiliary function are specified from the CNC, and the system is awaiting the auxiliary function completion signal after completion of the specified axis movement:

- 0 : An alarm (No.130) is issued when an axis control command is issued from the PMC for the same axis.
- 1 : An axis control command, when issued from the PMC for the same axis, is executed.

NMT When a command is specified from the CNC for the axis on which the tool is moving according to axis control specification from the PMC:

- 0 : P/S alarm No.130 is issued.
- 1 : The command is executed without issuing an alarm, provided the command does not involve a movement on the axis.

JFM This parameter sets the units used to specify feedrate data when continuous feed is specified in axis control by the PMC.

Increment system	JFM	Millimeter input	Inch input	Rotation axis
IS-B	0	1 mm/min	0.01 inch/min	0.00023 rpm
	1	200 mm/min	2.00 inch/min	0.046 rpm
IS-C	0	0.1 mm/min	0.001 inch/min	0.000023 rpm
	1	20 mm/min	0.200 inch/min	0.0046 rpm

G8C Look-ahead control for the axes controlled by the PMC is:

- 0 : Disabled.
- 1 : Enabled.

NOTE
This parameter is valid for an axis for which bit 7 (NAHx) of parameter No.1819 is set to 0.

- G8R** Look-ahead control over axes controlled by the PMC is:
 0 : Enabled for cutting feed (disabled for rapid traverse).
 1 : Enabled for both cutting feed and rapid traverse.

NOTE

This parameter is valid for an axis for which bit 7 (NAHx) of parameter No.1819 is set to 0.

- DSL** If the selection of an axis is changed when PMC axis selection is disabled:
 0 : P/S alarm No.139 is issued.
 1 : The change is valid, and no alarm is issued for an unspecified system.
- NCI** In axis control by the PMC, a position check at the time of deceleration is:
 0 : Performed.
 1 : Not performed.
- NDI** For PMC axis control, when diameter programming is specified for a PMC-controlled axis:
 0 : The amount of travel and feedrate are each specified with a radius.
 1 : The amount of travel and feedrate are each specified with a diameter.

NOTE

NDI is valid for an axis for which diameter programming is specified (bit 3 (DIAx) of parameter No. 1006 is set to 1) when bit 1 (CDI) of parameter No. 8005 is set to 0.

	#7	#6	#5	#4	#3	#2	#1	#0
8005	MFD		IFV		DRR	R10	CDI	EDC

[Data type] Bit

- EDC** In PMC-based axis control, an external deceleration signal is:
 0 : Disabled.
 1 : Enabled.
- CDI** For PMC axis control, when diameter programming is specified for a PMC-controlled axis:
 0 : The amount of travel and feedrate are each specified with a radius.
 1 : The amount of travel is specified with a diameter while the feedrate is specified with a radius.

NOTE

- This parameter is valid when bit 3 (DIA) of parameter No.1006 is set to 1.
- When CDI is set to 1, bit 7 (NDI) of parameter No.8004 is disabled.

- R10** When the RPD parameter (bit 0 of parameter No.8002) is set to 1, the unit for specifying a rapid traverse rate for the PMC axis is:
 0 : 1 mm/min.
 1 : 10 mm/min.

DRR For cutting feed per rotation in PMC axis control, the dry run function is:
 0 : Disabled.
 1 : Enabled.

IFV Override for each group in PMC axis control is:
 0 : Disabled.
 1 : Enabled.

MFD Output by each auxiliary function of the PMC axis control function is:
 0 : Disabled.
 1 : Enabled.

	#7	#6	#5	#4	#3	#2	#1	#0
8006						IPA	EML	

[Data type] Bit

EML When bit 0 (MLE) of parameter No. 8001 is set to 1, for PMC axes:
 0 : The all axis machine lock signal and axis-by-axis machine lock signals are disabled.
 1 : The all axis machine lock signal is disabled and the axis-by-axis machine lock signals are enabled.

IPA For PMC-dedicated axes:
 0 : The in-position check is performed when no move command is issued for the PMC axis.
 1 : No in-position check is always performed.

	#7	#6	#5	#4	#3	#2	#1	#0
8008								MIRx

[Data type] Bit axis

MIRx When a PMC axis control command is issued in mirror image mode, the mirror image is:
 0 : Not considered.
 1 : Considered.

This parameter is valid when PMC signals MI1 to MI8 <bits 0 to 7 of G106> are set to “1” or bit 0 (MIRx) of parameter No. 0012 is set to “1”.

8010	Selection of the DI/DO group for each axis controlled by the PMC
------	--

[Data type] Byte axis

[Valid data range] 1 to 4

Specify the DI/DO group to be used to specify a command for each PMC-controlled axis.

Value	Description
1	DI/DO group A (G142 to G153) is used.
2	DI/DO group B (G154 to G165) is used.
3	DI/DO group C (G166 to G177) is used.
4	DI/DO group D (G178 to G189) is used.

8020

Low-speed feedrate at reference position return in axis control by PMC (FL)

[Data type] Word axis**[Unit of data, Valid data range]**

Increment system	Unit of data	Valid data range	
		IS-B	IS-C
Millimeter machine	1 mm/min	6 to 15000	6 to 12000
Inch machine	0.1 inch/min	6 to 6000	6 to 4800
Rotation axis	1 deg/min	6 to 15000	6 to 12000

This parameter specifies the low-speed feedrate at a reference position return on a PMC-controlled axis (FL).

NOTE

If 0 is specified, the value of parameter No. 1425 is used.

8021

Minimum speed of rapid traverse override in axis control by PMC (Fo)

[Data type] Word axis**[Unit of data, Valid data range]**

Increment system	Unit of data	Valid data range	
		IS-B	IS-C
Millimeter machine	1 mm/min	6 to 15000	6 to 12000
Inch machine	0.1 inch/min	6 to 6000	6 to 4800
Rotation axis	1 deg/min	6 to 15000	6 to 12000

This parameter specifies the minimum speed of rapid traverse override on a PMC-controlled axis (Fo).

8022

Upper-limit rate of feed per revolution during PMC axis control

[Data type] Word**[Unit of data]****[Valid data range]**

Increment system	Unit data	Valid data range	
		IS-B	IS-C
Millimeter machine	1 mm/min	6 to 15000	6 to 12000
Inch machine	0.1 inch/min	6 to 6000	6 to 4800
Rotation axis	1 deg/min	6 to 15000	6 to 12000

This parameter sets the upper limit rate of feed per revolution during PMC axis control.

NOTE

The upper limit specified for the first axis is valid for all axes. The specifications for the second and subsequent axes are ignored.

8028

Linear acceleration/deceleration time constant for speed commands for PMC axis control

[Data type] Word axis**[Unit of data]** ms/1000 min⁻¹**[Valid data range]** 0 to 32767

This parameter sets the time required for the servo motor rotation speed to increase or decrease by 1000 min⁻¹, for each axis, as a linear acceleration/deceleration time constant for speed commands for PMC axis control.

NOTE

If this parameter is set to 0, acceleration/deceleration control is not applied.

4.64 PARAMETERS OF TWO-PATH CONTROL

	#7	#6	#5	#4	#3	#2	#1	#0
8100		DSB	COF				IAL	RST
								RST

[Data type] Bit

- RST** Reset key on the MDI panel
 0 : Effective for both paths, or in the M series, for both machining and background drawing sides
 1 : Effective for a path selected by the path selection signal, or in the M series, for the background drawing side.
- IAL** When an alarm is raised in one tool post in the automatic operation mode,
 0 : The other path enters the feed hold state and stops.
 1 : The other path continues operation without stopping.
- COF** Tool post 1 and tool post 2 (under two-path control) use:
 0 : Their own tool compensation memories.
 1 : Common tool compensation memory.
- DSB** The special single block function (under two-path control) is:
 0 : Disabled.
 1 : Enabled.

8110	Waiting M code range (minimum value)
------	--------------------------------------

[Data type] 2-word

[Valid data range] 0 and 100 to 99999999

This parameter specifies the minimum value of the waiting M code.

The waiting M code range is specified using parameter 8110 (minimum value) and parameter 8111 (maximum value).

(parameter 8110) ≤ (waiting M code) ≤ (parameter 8111)

NOTE
 A value of 0 indicates that the waiting M code is not used.

8111	Waiting M code range (maximum value)
------	--------------------------------------

[Data type] 2-word

[Valid data range] 0 and 100 to 99999999

This parameter specifies the maximum value of the waiting M code.

4.65 PARAMETERS OF CHECKING INTERFERENCE BETWEEN TOOL POSTS (TWO-PATH CONTROL)

	#7	#6	#5	#4	#3	#2	#1	#0
8140			ZCL	IFE	IFM	ITO	TY1	TY0
				IFE	IFM			

[Data type] Bit

TY0, TY1 This parameter specifies the relationship between the coordinate systems of the two tool paths.

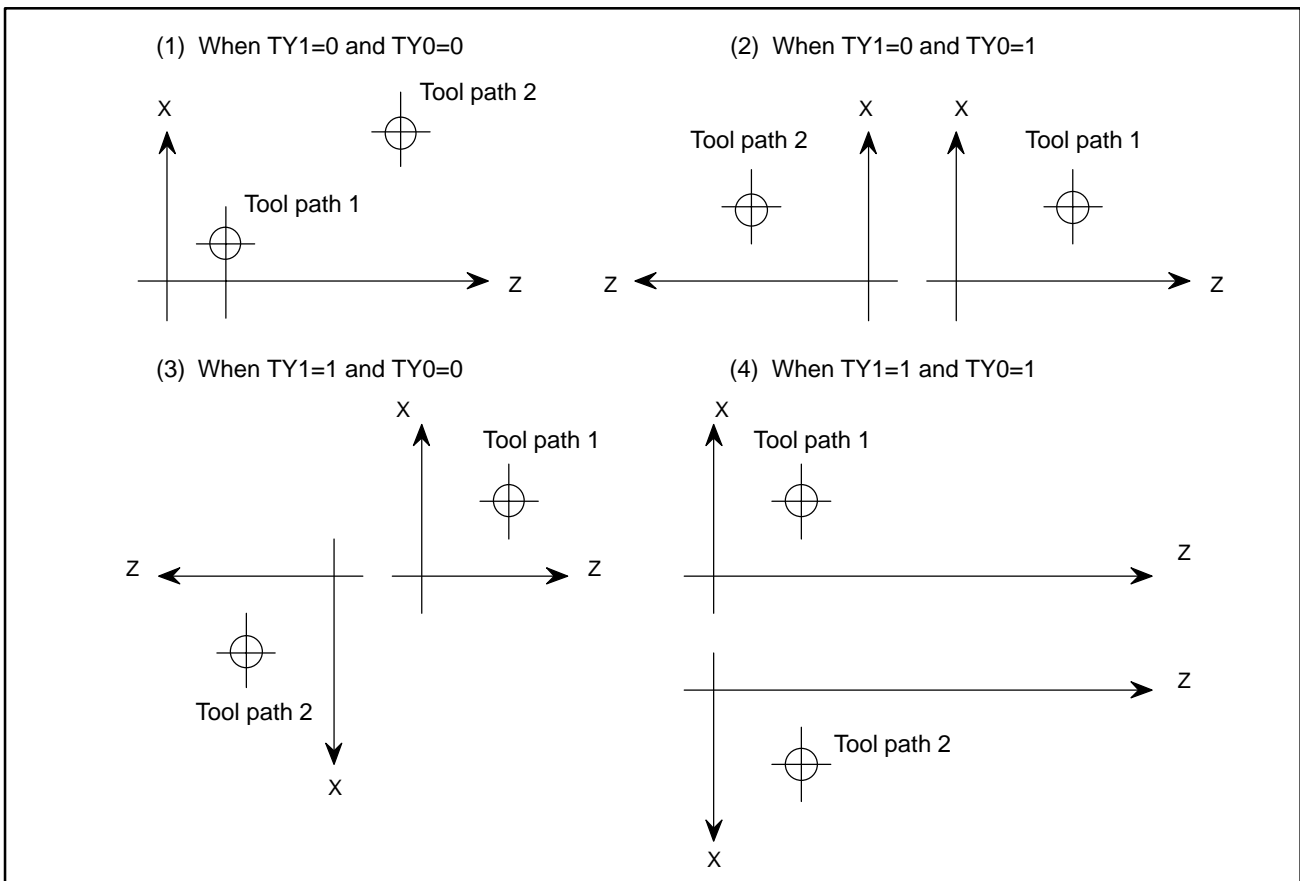

ITO When offset number 0 is specified by the T code,
 0 : Checking interference between tool posts is stopped until an offset number other than 0 is specified by the next T code.
 1 : Checking interference between tool posts is continued according to the previously specified offset number.

IFM In manual mode, a tool post interference check (T series) and inter-2-path interference check (M series) are:
 0 : Not performed.
 1 : Performed.

IFE A tool post interference check (T series) and inter-2-path interference check (M series) are:

- 0 : Performed.
- 1 : Not performed.

ZCL Specifies whether interference along the Z axis is checked while checking interference between tool posts.

- 0 : Checked
- 1 : Not checked (Only interference along the X axis is checked.)

8141	
	Distance along the X-axis from a path-1 reference point to a path-2 reference point

8142	
	Distance along the Y-axis from a path-1 reference point to a path-2 reference point

8143	
	Distance along the Z-axis from a path-1 reference point to a path-2 reference point

[Data type] 2-word

[Unit of data]

Increment system	IS-A	IS-B	IS-C	Units
Millimeter machine	0.01	0.001	0.0001	mm
Inch machine	0.001	0.0001	0.00001	inch
Rotation axis	0.01	0.001	0.0001	deg

[Valid data range] -99999999 to 99999999

8144	
	Interference check area figure data AI (BI)

8145	
	Interference check area figure data AJ (BJ)

8146	
	Interference check area figure data AK (BK)

8147	
	Interference check area figure data AX (BX)

8148	
	Interference check area figure data AY (BY)

8149	
	Interference check area figure data AZ (BZ)

[Data type] 2-word

[Unit of data]

Increment system	IS-A	IS-B	IS-C	Units
Millimeter machine	0.01	0.001	0.0001	mm
Inch machine	0.001	0.0001	0.00001	inch
Rotation axis	0.01	0.001	0.0001	deg

[Valid data range] -99999999 to 99999999

8151	Distance along the X axis between the reference positions of tool posts 1 and 2
8152	Distance along the Z axis between the reference positions of tool posts 1 and 2

[Data type] 2-word

[Unit of data]

Increment system	IS-B	IS-C	Unit
Millimeter machine	0.001	0.0001	mm
Inch machine	0.0001	0.00001	inch

[Valid data range] -99999999 to 99999999

Distance between tool posts is set in these parameters.

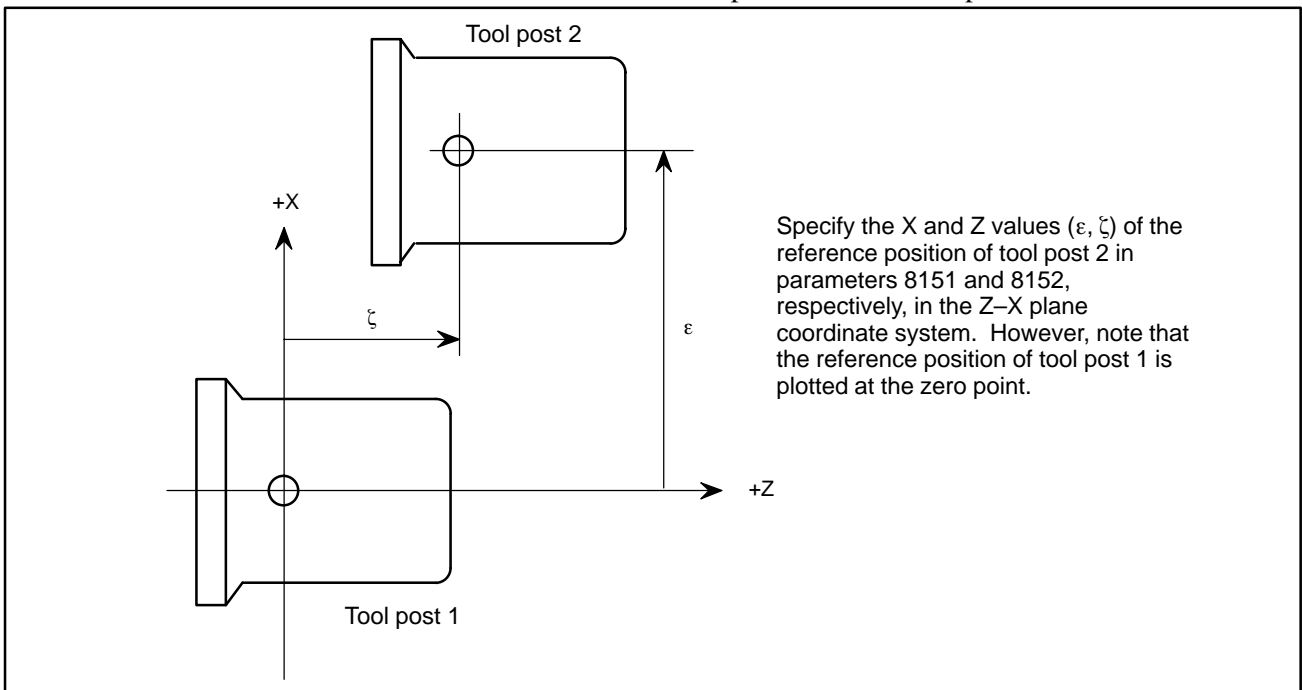

NOTE

After the parameter values are changed, perform manual reference position return for individual tool posts. Otherwise, data on the positional relationship between the tool posts stored in memory will not be updated to the new parameter values.

4.66 PARAMETERS OF PATH AXIS REASSIGNMENT

	#7	#6	#5	#4	#3	#2	#1	#0
8160	NRS	SPE	NCS			ZSI	XSI	MXC

[Data type] Bit

- MXC** During mixed control of the X- or Z-axis, measurement direct input function B for tool compensation performs calculation based on:
 0 : Machine coordinates for the path being controlled
 1 : Machine coordinates for another path subject to mixed control

NOTE

- 1 This parameter is valid for setting tool compensation values for the X- or Z axis and setting shift of the workpiece coordinate system for the Z-axis.
- 2 This parameter cannot be used when mixed control is applied to paths for which different minimum command increments (metric or inch) are specified.

- XSI** When $MXC = 1$, the machine coordinates along the X-axis for the other path subject to mixed control are fetched:
 0 : With the sign as is
 1 : With the sign inverted

- ZSI** When $MXC = 1$, machine coordinates along the Z-axis for the other path subject to mixed control are fetched:
 0 : With the sign as is
 1 : With the sign inverted

- NCS** If an overtravel alarm is issued for an axis under synchronous, composite, or superimposed control, synchronous, composite, or superimposed control is:
 0 : Released.
 1 : Not released.

If an overtravel alarm is issued for an axis under synchronous, composite, or superimposed control, the following operation is performed according to the setting of this parameter:

When NCS is set to 0 P/S alarm No. 255 may be issued together with the overtravel alarm. In this case, place the machine in the emergency stop state once, then release the alarm.

When NCS is set to 1 The machine decelerates, then stops with a delay of 8 msec in comparison with an ordinary overtravel alarm.

- SPE** The synchronization deviation is:
 0 : The difference between the positioning deviation of the master axis and that of the slave axis.
 1 : The difference between the positioning deviation of the master axis and that of the slave axis plus the acceleration/deceleration delay.

NOTE

When the master and slave axes have different acceleration/deceleration time constants, set 1.

- NRS** When the system is reset, synchronous, composite, or superimposed control is:
 0 : Released.
 1 : Not released.

	#7	#6	#5	#4	#3	#2	#1	#0
8161			CRZ	CMW			CZM	NMR

[Data type] Bit

- NMR** When an axis subject to mixed control is placed in servo-off state:
 0 : Mixed control is stopped.
 1 : Mixed control is not stopped, provided bit 0 (FUP) of parameter No.1819 is set to 1 to disable follow-up for the axis.

NOTE

Mixed control is not stopped only when bit 0 (FUP) of parameter No.1819 is set to 1. If follow-up is disabled with the follow-up signal (*FLWU <G007 bit 5> =1), mixed control is stopped.

- CZM** When two Cs contour axes are subject to mixed control, the function for mixing zero point return commands for Cs contour axes is:
 0 : Not used
 1 : Used
- CMW** When the function for mixing zero point return commands for Cs contour axes is used (CZM = 1) with the workpiece coordinate system set function, at completion of Cs zero point return, the coordinate system is set:
 0 : Based on the machine coordinate of the Cs contour axis on the same path.
 1 : Based on the machine coordinate of the Cs contour axis of the composite destination.
- CRZ** When the function for mixing zero point return commands for Cs contour axes is used (CZM = 1), for a positioning command for a CS contour axis immediately after composite control switching between Cs contour axes:
 0 : Normal positioning operation is performed.
 1 : Positioning operation including zero point return is performed.

	#7	#6	#5	#4	#3	#2	#1	#0
8162	MUMx	MCDx	MPSx	MPMx	OMRx	PKUx	SERx	SMRx

[Data type] Bit axis

SMRx Synchronous mirror-image control is:
 0 : Not applied. (The master and slave axes move in the same direction.)
 1 : Applied. (The master and slave axes move in opposite directions.)

SERx The synchronization deviation is:
 0 : Not detected.
 1 : Detected.

NOTE

When both master and slave axes move in synchronization, the positioning deviations of the corresponding axes are compared with each other. If the difference is greater than or equal to the value specified in parameter No.8181, an alarm occurs. When either axis is in the parking or machine-locked state, however, the synchronization deviation is not detected.

PKUx In the parking state,
 0 : The absolute, relative, and machine coordinates are not updated.
 1 : The absolute and relative coordinates are updated. The machine coordinates are not updated.

OMRx Superimposed mirror-image control is:
 0 : Not applied. (The superimposed pulse is simply added.)
 1 : Applied. (The inverted superimposed pulse is added.)

MPMx When composite control is started, the workpiece coordinate system is:
 0 : Not set automatically.
 1 : Set automatically.

NOTE

When the workpiece coordinate system is automatically set at the start of composite control, it is calculated from the following: Current machine coordinates and the workpiece coordinates at the reference point of each axis (parameter No.8184).

MPSx When composite control is terminated, the workpiece coordinate system is:
 0 : Not set automatically.
 1 : Set automatically.

NOTE

When the workpiece coordinate system is automatically set at the end of composite control, it is calculated from the following: Current machine coordinates and the workpiece coordinates at the reference point of each axis under composite control (parameter No.1250)

MCDx The axes to be replaced with each other under composite control have the coordinate systems placed:
 0 : In the same direction. Simple composite control is applied. (The axes of paths 1 and 2 move in the same direction.)
 1 : In opposite directions. Mirror-image composite control is applied. (The axes of paths 1 and 2 move in opposite directions.)
 This parameter determines the direction in which an axis moves. The parameter is also used to automatically set the coordinate system when composite control is started or terminated.

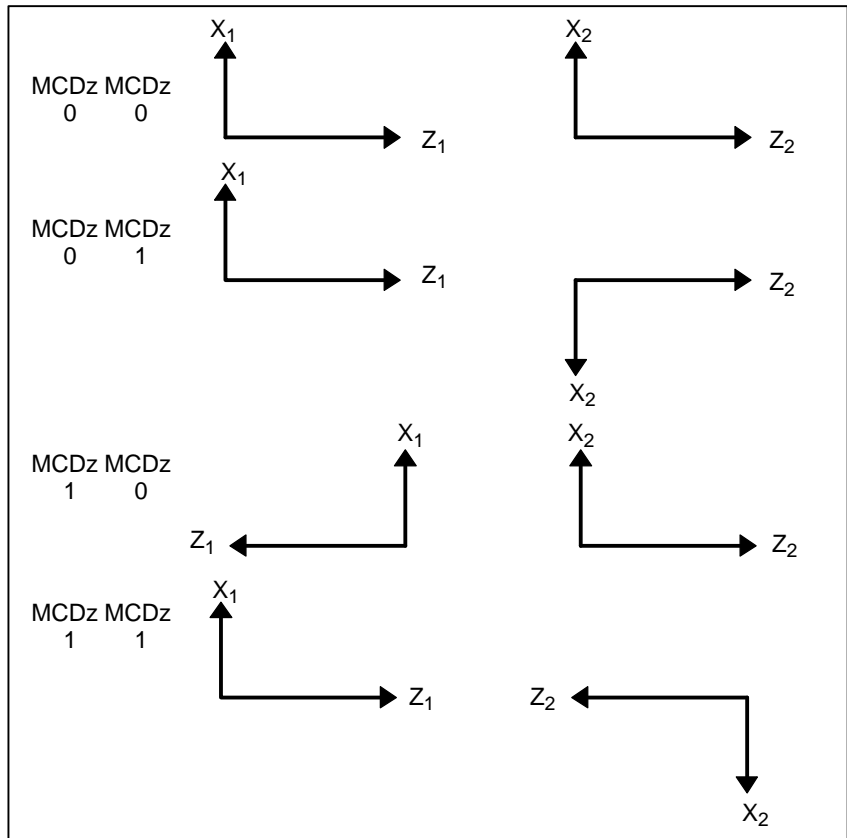

MUMx In mixed control, a move command for the axis:
 0 : Can be specified.
 1 : Cannot be specified.

NOTE
 Upon the execution of a move command along an axis for which MUMx is set to 1 during mixed control, alarm P/S No.226 is issued.

	#7	#6	#5	#4	#3	#2	#1	#0
8163	NUMx			SCDx	SCMx	SPSx	SPMx	MDXx

NOTE

Set the parameters SPMx, SPSx, SCMx, and SCDx for the master axis. These settings are referenced during automatic workpiece coordinate setting for the master axis at the start of synchronous control.

[Data type] Bit axis

MDXx In mixed control, the current position (absolute/relative coordinates) display indicates:

0 : Coordinates in the local system.

1 : Coordinates in the other system under mixed control.

SPMx When synchronous control is started, automatic workpiece coordinate system setting for the master axis is

0 : Not Performed.

1 : Performed.

NOTE

When a workpiece coordinate system is automatically set at the start of synchronous control, the workpiece coordinate system is calculated from the current machine coordinates and the workpiece coordinates of each axis at the reference position set in parameter No.8185.

SPSx When synchronous control terminates, automatic workpiece coordinate system setting for the master axis is:

0 : Not performed.

1 : Performed.

NOTE

When a workpiece coordinate system is automatically set at the end of synchronous control, the workpiece coordinate system is calculated from the current machine coordinates and the workpiece coordinates for each axis at the reference position set in parameter No.1250.

SCMx When workpiece coordinates are calculated in synchronous control:

0 : The workpiece coordinates are calculated from the machine coordinates of the slave axis.

1 : The workpiece coordinates are calculated from the machine coordinates of the master axis and slave axis.

SCDx The positive (+) directions of the master axis and slave axis in the coordinate system in synchronous control are:

0 : Identical.

1 : Opposite.

NUMx When neither synchronous control nor mixed control is applied, a move command for the axis is:

0 : Not disabled.

1 : Disabled.

NOTE

If a move command is specified for an axis with NUMx set to 1 when neither synchronous control nor mixed control is applied, P/S alarm No.226 is issued.

	#7	#6	#5	#4	#3	#2	#1	#0
8164		SOKx	OPSx	SPNx	MCEx	MCSx	MWEx	MWSx

[Data type] Bit axis

MWSx In automatic workpiece coordinate system setting, performed when composite control is started, a workpiece shift and position offset are:
 0 : Not considered.
 1 : Considered.

NOTE

MWSx is enabled when (bit 4 (MPMx) of parameter No.8162) is set to 1.

MWEx In automatic workpiece coordinate system setting, performed when composite control is canceled, a workpiece shift and position offset are:
 0 : Not considered.
 1 : Considered.

NOTE

MWEx is enabled when (bit 5 (MPSx) of parameter No.8162) is set to 1.

MCSx In automatic workpiece coordinate system setting, performed when composite control is started:
 0 : A workpiece coordinate system is automatically set in the same way as normal.
 1 : The coordinate system of the other path subject to axis recombination is used.

NOTE

MCSx is enabled when (bit 4 (MPMx) of parameter No.8162) is set to 1.

MCEx In automatic workpiece coordinate system setting, performed when composite control is canceled:
 0 : A workpiece coordinate system is automatically set in the same way as normal.
 1 : The coordinate system of the other path subject to axis recombination is used.

NOTE

MCEx is enabled when (bit 5 (MPSx) of parameter No.8162) is set to 1.

- SPNx** The workpiece coordinate and relative coordinate of a slave axis subject to synchronous control is:
 0 : Updated.
 1 : Not updated.
- OPSx** When superimposed control is canceled, control in which an amount of movement along a master axis subject to superimposed control is added to the workpiece coordinate of a slave axis is:
 0 : Not applied.
 1 : Applied.
- SOKx** If a master axis subject to superimposed control is also subject to synchronous control:
 0 : An alarm is issued when superimposed control is started during synchronous control.
 1 : No alarm is issued when superimposed control is started during synchronous control.

NOTE

- 1 MWSx and MWEx are mutually exclusive, so that only one of these parameters must be selected. Similarly, MCSx and MCEx are mutually exclusive, so that only one of these parameters must be selected.
- 2 Specify these parameters for the axis of each path subject to each control function.

	#7	#6	#5	#4	#3	#2	#1	#0
8165							SVF	SIC

NOTE

When this parameter has been set, the power must be turned off before operation is continued.

[Data type] Bit

- SIC** One-path superimposed control is:
 0 : Disabled.
 1 : Enabled.
- SVF** In synchronous or composite control, for an axis under synchronous or composite control on the other path, the feed-forward function and the cutting feed and rapid traverse switching function are:
 0 : Disabled.
 1 : Enabled.

	#7	#6	#5	#4	#3	#2	#1	#0
8166						OVL	MIX	SYN

NOTE
 When this parameter has been set, the power must be turned off before operation is continued.

[Data type] Bit

SYN Three-path synchronous control is:
 0 : Enabled.
 1 : Disabled.

MIX Three-path composite control is:
 0 : Enabled.
 1 : Disabled.

OVL Three-path superimposed control is:
 0 : Enabled.
 1 : Disabled.

8180	Master axis with which an axis is synchronized under synchronous control

[Data type] Byte axis

[Valid data range] 1, 2, 3, ... to the maximum number of control axes, or 201, 202, 203, ... to 200 plus the maximum number of control axes

This parameter specifies the number of the master axis with which an axis is synchronized. When zero is specified, the axis does not become a slave axis and is not synchronized with another axis. When an identical number is specified in two or more axes, one master axis has two or more slave axes.

- Exercising synchronous control between two paths
 In the parameter of a slave axis, specify the axis number of the master axis with which the slave axis is to be synchronized.
 Setting: 1 to 8
 The value specified here must not exceed the maximum number of control axes.

(Example 1) Synchronizing the Z₂-axis with the Z₁-axis

Path 1	Path 2
Parameter No.8180x 0	Parameter No.8180x 0
Parameter No.8180z 0	Parameter No.8180z 2
Parameter No.8180c 0	
Parameter No.8180y 0	

- Exercising synchronous control in a path
 In the parameter of a slave axis, specify 200 plus the number of the master axis with which the slave axis is to be synchronized.
 Setting: 201 to 208
 The value specified here must not exceed 200 plus the maximum number of control axes.

(Example 2) Synchronizing the Y₁-axis with the Z₁-axis

	Tool post 1	Tool post 2
Parameter No.8180x	0	Parameter No.8180x 0
Parameter No.8180z	0	Parameter No.8180z 0
Parameter No.8180c	0	
Parameter No.8180y	202	

8181	Synchronization error limit of each axis (Synchronous or composite control)
------	---

[Data type] 2-word axis

[Unit of data] Unit of detection

[Valid data range] 0 to 32767

When the synchronization deviation detected (SERx of Bit #1 parameter No.8162 is set to 1), this parameter specifies the limit of the difference between the positioning deviation of the slave axis and that of the master axis. Set this parameter to the slave axis.

8182	Display of the synchronization error of an axis (synchronous or composite control)
------	--

[Data type] 2-word axis

[Unit of data] Unit of detection

[Valid data range] 0 or more

When the synchronization deviation is detected (SERx of Bit #1 parameter No.8162 is set to 1), this parameter specifies the difference between the positioning deviation of the slave axis and that of the master axis. (The value is used for diagnosis.) The deviation is displayed on the slave side

The parameter is only of display. It should not be set.

The difference between the positioning deviation is:

(Positioning deviation of the master axis) \pm (Positioning deviation of the slave axis)

↑
 Plus for a mirror-image synchronization command
 Minus for a simple synchronization command

NOTE

Parameter No.8182 is only for display. It cannot be set value.

8183	Axis under composite control in path 1 corresponding to an axis of path 2
------	---

[Data type] Byte axis

[Valid data range] 1, 2, 3, ... to the maximum number of control axes

This parameter specifies an axis of path 1 to be placed under composite control with each axis of path 2. The value specified here must not exceed the maximum number of axes that can be used in path 1. When zero is specified, control of the axis is not replaced under composite control. An identical number can be specified in two or more axes, but composite control cannot be exercised for all of them at a time.

NOTE

Specify this parameter only for path 2.

(Example 1)

Exercising composite control to replace the X₁-axis with the X₂-axis

Tool post 1	Tool post 2
Parameter No.8183x 0	Parameter No.8183x 1
Parameter No.8183z 0	Parameter No.8183z 0
Parameter No.8183c 0	
Parameter No.8183y 0	

(Example 2)

Exercising composite control to replace the Y₁-axis with the X₂-axis

Tool post 1	Tool post 2
Parameter No.8183x 0	Parameter No.8183x 4
Parameter No.8183z 0	Parameter No.8183z 0
Parameter No.8183c 0	
Parameter No.8183y 0	

8184	Coordinates of the reference point of an axis on the coordinate system of another axis under composite control
------	--

[Data type] 2-word axis

[Unit of data]

Increment system	IS-A	IS-B	IS-C	Unit
Millimeter machine	0.01	0.001	0.0001	mm
Inch machine	0.001	0.0001	0.00001	inch
Rotation axis	0.01	0.001	0.0001	deg

[Valid range] -99999999 to 99999999

This parameter specifies the coordinates of the reference point of an axis on the coordinate system of another axis under composite control. The parameter is validated when MPMx of bit 4 parameter No.8162 is set to 1.

Example

Exercising composite control to replace the X1-axis with the X2-axis

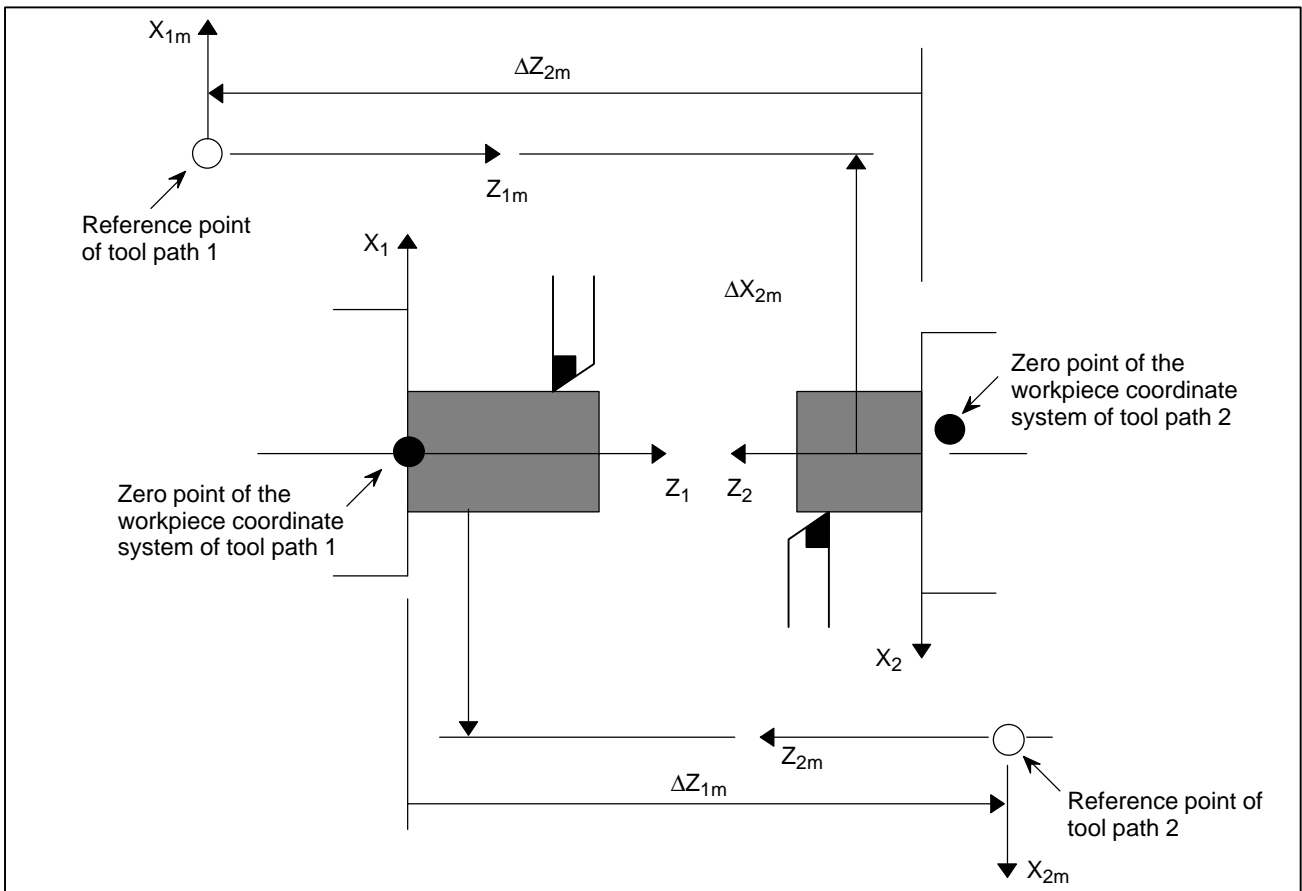

$(\Delta X_{1m}, \Delta Z_{1m})$ are the coordinates of the reference point of tool path 2 on the workpiece coordinate system of tool post 1. $(\Delta X_{2m}, \Delta Z_{2m})$ are the coordinates of the reference point of tool post 1 on the workpiece coordinate system of tool path 2.

ΔX_{1m} is specified for the X-axis of tool post 1 and ΔX_{2m} for the X-axis of tool post 2.

If bit 4 of parameter No.8162 MPMx is set to 1 when composite control is started, the workpiece coordinate system satisfying the following conditions is specified:

$$\mathbf{X}_1 = (\text{Value specified for the X-axis of tool post 1}) \pm (\text{Machine coordinate of X}_2)$$

↑
 Plus when parameter No.8162 MCDx of tool post 1 is set to 0
 Minus when parameter No.8162 MCDx of tool post 1 is set to 1

$$\mathbf{X}_2 = (\text{Value specified for the X-axis of tool post 2}) \pm (\text{Machine coordinate of X}_1)$$

↑
 Plus when parameter No.8162 MCDx of tool post 2 is set to 0
 Minus when parameter No.8162 MCDx of tool post 2 is set to 1

If bit 5 of parameter No.8162 MPSx is set to 1 when composite control is terminated, the workpiece coordinate system satisfying the following conditions is specified:

X_1 = Parameter No.1250 of tool post 1 + Machine coordinate of X_1

X_2 = Parameter No.1250 of tool post 2 + Machine coordinate of X_2

8185	Workpiece coordinates on each axis at the reference position
------	--

[Data type] 2-word axis

[Unit of data]

Increment system	IS-A	IS-B	IS-C	Unit
Millimeter machine	0.01	0.001	0.0001	mm
Inch machine	0.001	0.0001	0.00001	inch
Rotation axis	0.01	0.001	0.0001	deg

[Valid data range] -99999999 to 99999999

This parameter sets the workpiece coordinates on each master axis, subject to synchronous control, when the master and slave axes are at the reference position. This parameter is enabled when SPMx of bit 1 parameter No.8163 is set to 1. Set this parameter for the master axis.

8186	Master axis under superimposed control
------	--

[Data type] Byte axis

[Valid range] 1, 2, 3, ... to number of control axes

This parameter specifies the axis number of the master axis under superimposed control.

When zero is specified, the axis does not become a slave axis under superimposed control and the move pulse of another axis is not superimposed.

8190	Rapid traverse rate of an axis under superimposed control
------	---

[Data type] 2-word axis

[Unit of data]

[Valid data range]

Increment system	Unit of data	Valid data range	
		IS-A, IS-B	IS-C
Millimeter machine	1 mm/min	30 to 240000	30 to 100000
Inch machine	0.1 inch/min	30 to 96000	30 to 48000
Rotation axis	1 deg/min	30 to 240000	30 to 100000

Set a rapid traverse rate for each of the axes when the rapid traverse override of the axes (master and slave axes) under superimposed control is 100%.

8191	F0 velocity of rapid traverse override of an axis under superimposed control

[Data type] Word axis

[Unit of data]	Increment system	Unit of data	Valid data range	
			IS-A, IS-B	IS-C
[Valid data range]	Millimeter machine	1 mm/min	6 to 15000	6 to 12000
	Inch machine	0.1 inch/min	6 to 6000	6 to 4800
	Rotation axis	1 deg/min	6 to 15000	6 to 12000

This parameter specifies the maximum cutting feedrate for an axis under superimposed control.

8192	Linear acceleration/deceleration time constant in rapid traverse of an axis under superimposed control

[Data type] Word axis

[Unit of data] ms

[Valid range] 0 to 4000

This parameter specifies the linear acceleration/deceleration time constant in rapid traverse for each of the axes (master and slave axes) under superimposed control.

8193	Maximum cutting feedrate under superimposed control

[Data type] 2 words

[Unit of data and valid range]

Increment system	Unit of data	Valid range	
		IS-A, IS-B	IS-C
Millimeter machine	1 mm/min	30 to 240000	30 to 100000
Inch machine	0.1 inch/min	30 to 96000	30 to 48000
Rotation axis	1 deg/min	30 to 240000	30 to 100000

This parameter specifies the maximum cutting feedrate under superimposed control.

4.67 PARAMETERS OF ANGULAR AXIS CONTROL

	#7	#6	#5	#4	#3	#2	#1	#0
8200					AZP	AZR		AAC

NOTE

When this parameter is set, the power must be turned off before operation is continued.

[Data type] Bit

AAC

- 0 : Does not perform angular axis control.
- 1 : Performs inclined axis control.

AZR

- 0 : The machine tool is moved along the Cartesian axis during manual reference position return along the slanted axis under angular axis control.
- 1 : The machine tool is not moved along the Cartesian axis during manual reference position return along the slanted axis under angular axis control.

- AZP** When an angular axis moves, the reference position return completion signal for the Cartesian axis, ZPx <F094, F096, F098, F100, or F116>, is:
- 0 : Not cleared.
 - 1 : Cleared.

	#7	#6	#5	#4	#3	#2	#1	#0
8201	ADG					AO3	AO2	AOT

[Data type] Bit

- AOT** When angular axis control is enabled, the values indicating the area for stored stroke check 1 (parameters Nos. 1320 and 1321) are treated as:
- 0 : Coordinates in the angular coordinate system.
 - 1 : Coordinates in the Cartesian coordinate system.
- AO2** When angular axis control is enabled, the values indicating the area for stored stroke check 2 (parameters Nos. 1322 and 1323) are treated as:
- 0 : Coordinates in the angular coordinate system.
 - 1 : Coordinates in the Cartesian coordinate system.
- AO3** When angular axis control is enabled, the values indicating the area for stored stroke check 3 (parameters Nos. 1324 and 1325) are treated as:
- 0 : Coordinates in the angular coordinate system.
 - 1 : Coordinates in the Cartesian coordinate system.
- ADG** The contents of diagnostic data Nos. 306 and 307 are:
- 0 : Not swapped. The angular axis and Cartesian axis are displayed in this order.
 - 1 : Swapped. The Cartesian axis and angular axis are displayed in this order.

8210

Inclination angle for angular axis control

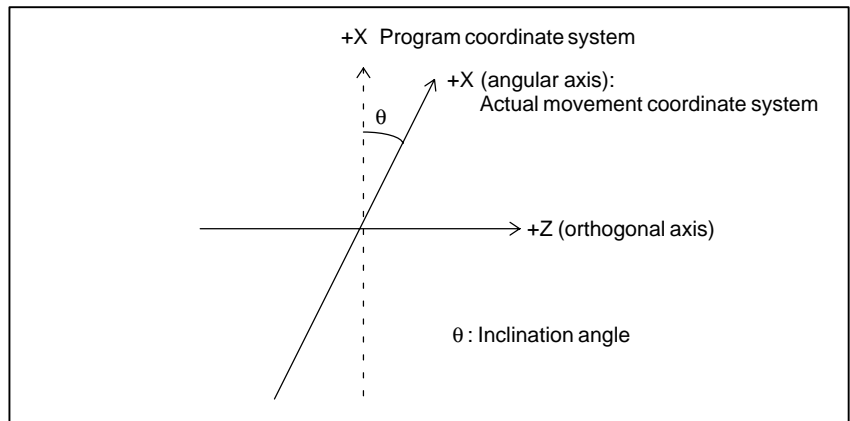
[Data type] 2 words**[Unit of data]** 0.001 degree**[Valid data range]** 20000 to 60000

8211

Axis number of a slanted axis subject to slanted axis control

8212

Axis number of a Cartesian axis subject to slanted axis control

[Data type] Word**[Unit of data]** Number**[Valid data range]** 1 to number of controlled axes

These parameters set the axis numbers of a slanted axis and Cartesian axis subject to slanted axis control.

4.68 PARAMETERS OF B-AXIS CONTROL

	#7	#6	#5	#4	#3	#2	#1	#0
8240	MST	ABS	SOV	TEM	REF			

[Data type] Bit

- REF** Reference position return operation by G28:
 0 : Always uses deceleration dogs in the same way as a manual reference position return operation.
 1 : Uses deceleration dogs when a reference position has not yet been set, but is performed by rapid traverse when a reference position has already been set (in the same way as an ordinary G28 command).
- TEM** When an offset movement is made in a block containing a T code:
 0 : M code and MF are output before a movement along an axis.
 1 : M code and MF are output after a movement along an axis.
- SOV** A G110 block:
 0 : Overlaps the next block.
 1 : Does not overlap the next block.
- ABS** The B-axis command is:
 0 : An incremental command.
 1 : An absolute command.
- MST** When an M code for starting a movement along the B-axis is specified:
 0 : Operation is started after a ready notice using the FIN signal is received.
 1 : Operation is started without waiting for a ready notice.

	#7	#6	#5	#4	#3	#2	#1	#0
8241						MDF	MDG	FXC

[Data type] Bit

- FXC** In canned cycle G84:
 0 : The spindle is rotated clockwise or counterclockwise after M05 is output.
 1 : The spindle is rotated clockwise or counterclockwise without first outputting M05.
- MDG** The initial continuous-state value for starting B-axis operation command registration is:
 0 : G00 mode (rapid traverse).
 1 : G01 mode (cutting feed).
- MDF** The initial continuous-state value for starting B-axis operation command registration is:
 0 : G98 (feed per minute).
 1 : G99 (feed per rotation).

	#7	#6	#5	#4	#3	#2	#1	#0
8242							BPF	COF

[Data type] Bit

COF For tool post 1 and tool post 2 (under two-path control):

- 0 : A separate B-axis offset value is set.
- 1 : A common B-axis offset value is set.

BPF For feed per revolution with the B-axis control function, the parameters for the unit of PMC feedrate data specification, FR1 and FR2 (bits 6 and 7 of parameter No. 8002) are:

- 0 : Valid.
- 1 : Invalid.

8250	Axis number used for B-axis control

[Data type] Byte

[Valid data range] 1 to number of controlled axes (in one-path control)
 11 to ((number of controlled axes for path 1) + 10), or
 21 to ((number of controlled axes for path 2) + 20) (in two-path control)

This parameter sets which axis is to be used for B-axis control.

In one-path control, set the controlled axis number of a selected B-axis.

In two-path control, set the axis number, used for B-axis control on path 1, added to 10 when a path 1 axis is used.

Set an axis number, used for B-axis control on path 2, added to 20 when a path 2 axis is used.

Example of setting:

- (1) For one-path control

When the fourth axis is controlled as the B-axis, set 4 in this parameter. Furthermore, specify a DI/DO number to be used for the fourth axis in parameter No.8010.
- (2) For two-path control
 - (a) When B-axis control is applied to path 1 only

When the fourth axis of path 1 is controlled as the B-axis, set 14 with this parameter. Furthermore, specify the DI/DO number to be used for the fourth axis with parameter No.8010 for path 1.
 - (b) When B-axis control is applied to path 2 only

When the fourth axis on path 2 is controlled as the B-axis, set 24 with this parameter. Furthermore, specify a DI/DO number to be used for the fourth axis in parameter No.8010 for path 2.
 - (c) When B-axis control is applied separately to path 1 and path 2

Make the settings described in (a) and (b) above.
 - (d) When B-axis control is simultaneously applied to both path 1 and path 2

When the fourth axis for path 1 is controlled as the common B-axis, set 14 with this parameter for both path 1 and path 2. Furthermore, specify a DI/DO number to be used for the fourth axis in parameter No.8010 for path 1.

8251	M code (G101) for specifying the start of first program operation
8252	M code (G102) for specifying the start of second program operation
8253	M code (G103) for specifying the start of third program operation

[Data type] 2-word

[Valid data range] 6 to 99999999

These parameters set M codes for starting previously registered B-axis operation programs. M codes (such as M30, M98, and M99), already used for other purposes, cannot be set.

8257	T code number for tool offset cancellation
------	--

[Data type] Byte

[Valid data range] 0 to 90

This parameter sets a T code number for tool offset cancellation. When a T code from (setting + 1) to (setting + 9) is specified, tool offset is specified.

8258	Clearance, used in canned cycle G83, for the B-axis
------	---

[Data type] 2-word

[Valid data range] 0 to 99999999

[Unit of data]

Increment system	IS-B	IS-C	Unit
Millimeter input	0.001	0.0001	mm
Inch input	0.0001	0.00001	inch

This parameter sets the clearance used for peck drilling cycle G83.

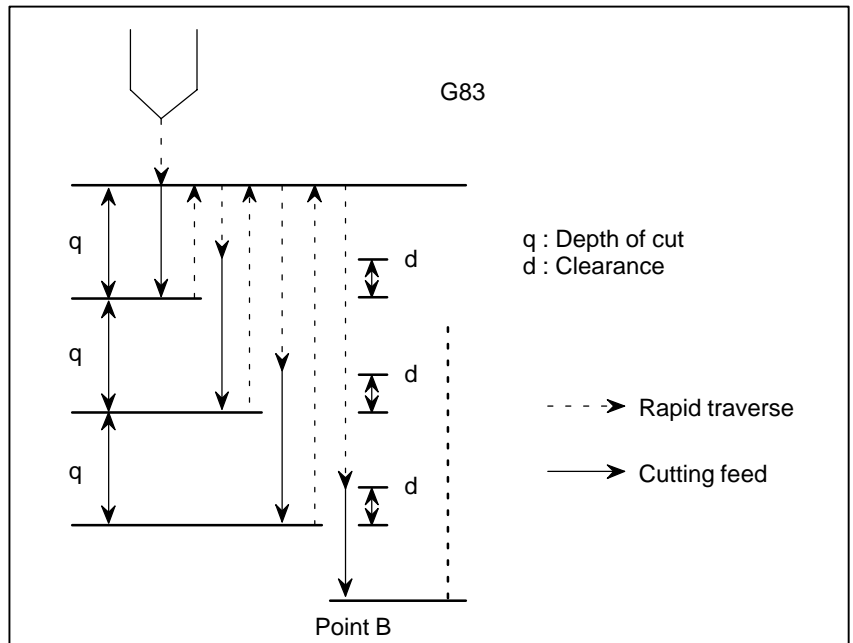

4.69 PARAMETERS OF SIMPLE SYNCHRONOUS CONTROL

	#7	#6	#5	#4	#3	#2	#1	#0
8301								
	SOF		SYE	SYA				

[Data type] Bit

SYA In the servo-off state in simple synchronous control, the limit of the difference between the positioning deviation of the master axis and that of the slave axis is:

- 0 : Not checked.
- 1 : Checked.

SYE During execution of synchronization, the limit of the difference between positioning deviations (parameter No. 8313 or 8323) is:

- 0 : Checked.
- 1 : Not checked.

SOF The synchronization function in simple synchronous control (one pair) is:

- 0 : Not used.
- 1 : Used.

	#7	#6	#5	#4	#3	#2	#1	#0
8302								
	SMA				SSE		ATS	ATE

NOTE

When this parameter is set, the power must be turned off before operation is continued.

[Data type] Bit

ATE Automatic setting of grid positioning for simplified synchronous control one pair is:

- 0 : Disabled
- 1 : Enabled

ATS Automatic setting of grid positioning for simplified synchronous control one pair is:

- 0 : Not started
- 1 : Started

NOTE

- 1 When the bits are set to 1, parameter No.8316 and bit 4 (APZx) of parameter No.1815 for the master and slave axes are set to 0.
- 2 These bits are automatically set to 0 once grid positioning has been completed.

SSE In simple synchronization control, the external machine coordinate system shift function for the slave axis is:

- 0 : Not used.
- 1 : Used.

For axes under simple synchronization control, when the external machine coordinate system shift is performed for the master axis, it can also be performed for the slave axis simultaneously.

NOTE

The simple synchronous signal must be manipulated. Carefully turn the simple synchronous signal on and off because the machine may move at that time.

SMA When bit 4x (APZx) of parameter No. 1015 is turned off for one axis under simple synchronous control, APZx for the other axis under simple synchronous control is:

0 : Not turned off.

1 : Turned off.

When an axis for which the simple synchronous axis parameter is set is under simple synchronous control, the simple synchronous signal is turned on for the axis.

	#7	#6	#5	#4	#3	#2	#1	#0
8303								
	SOFx						ATSx	ATEx

NOTE

After this parameter has been set, the power must be turned off then on again for the setting to become effective.

[Data type] Bit axis

ATEx In simple synchronous control, automatic setting for grid positioning is:
0 : Disabled.

1 : Enabled.

ATSx In simple synchronous control, automatic setting for grid positioning is:
0 : Not started.

1 : Started.

NOTE

When starting automatic setting for grid positioning, set ATSx to 1. Upon the completion of setting, ATSx is automatically set to 0.

SOFx In simple synchronous control, the synchronization function is:

0 : Not used.

1 : Used.

NOTE

Set this parameter on the master axis side.

	#7	#6	#5	#4	#3	#2	#1	#0
8304								
								USD

[Data type] Bit axis

USD In simple synchronous control, the uni-directional synchronization function uses:

0 : Axis of which machine coordinate is larger as the reference.

1 : Axis of which machine coordinate is smaller as the reference.

NOTE

Set this parameter (USD) to the same value for both the master and slave axes.

	#7	#6	#5	#4	#3	#2	#1	#0
8305								
							USE	USC

[Data type] Bit

USC In simple synchronous control, the uni-directional synchronization function is:

0 : Not used.

1 : Used.

NOTE

This parameter is valid only when bit 7 (SOF) of parameter No. 8301 or bit 7 (SOFx) of parameter No. 8303 is set to 1.

USE In simple synchronous control, after emergency stop, the uni-directional synchronization function is:

0 : Used.

1 : Not used.

NOTE

This parameter is valid only when bit 7 (SOF) of parameter No. 8301 or bit 7 (SOFx) of parameter No. 8303 is set to 1.

8311

Axis number of master axis in synchronous control

NOTE

When this parameter is set, the power must be turned off before operation is continued.

[Data type] Byte axis

<For the T Series>

Select a master axis and slave axis in simple synchronous control. Set a master axis number with a slave axis. For the parameters for the first axis through the fourth axis of parameter No.8311, set the following:

Units digit of the parameter for the first axis →

Set the axis number of a master axis for the first axis.

Tens digit of the parameter for the first axis →

Set the axis number of a master axis for the second axis.

Units digit of the parameter for the second axis →

Set the axis number of a master axis for the third axis.

Tens digit of the parameter for the second axis →

Set the axis number of a master axis for the fourth axis.

Units digit of the parameter for the third axis →

Set the axis number of a master axis for the fifth axis.

Tens digit of the parameter for the third axis →

Set the axis number of a master axis for the sixth axis.

Units digit of the parameter for the fourth axis →

Set the axis number of a master axis for the seventh axis.

Tens digit of the parameter for the fourth axis →

Set the axis number of a master axis for the eighth axis.

Number	Tens digit	Units digit
First axis	Second axis	First axis
Second axis	Fourth axis	Third axis
Third axis	Sixth axis	Fifth axis
Fourth axis	Eighth axis	Seventh axis

Note that the axis number settings are as follows:

0 → First axis, 1 → Second axis, 2 → Third axis, 3 → Fourth axis

Example: If the master and slave axes are assigned as the third and fourth axes, respectively, set up as follows:

No. 8311 First: 00
 Second: 20
 Third: 00
 Fourth: 00

NOTE

For an axis for which 0 is set, the first axis serves as the master axis. So, when the control signal for the axis is set to 1, the first axis serves as a master axis, and synchronous control is exercised.

<For the M Series>

[Valid data range] 0, 1 to Number of controlled axes

Select a master axis and slave axis in simple synchronous control. Set a master axis number with the slave axis side. The axis number settings are: 1 → First axis, 2 → Second axis, 3 → Third axis, 4 → Fourth axis. Up to four pairs can be specified.

Example1: Simple synchronous control is exercised with one pair.

When using the first axis (X-axis) as the master axis, and the third axis (Z-axis) as the slave axis, set parameter No.8311 as follows:

Parameter No. 8311 X (first axis) = 0
 Y (second axis) = 0
 Z (third axis) = 1
 A (fourth axis) = 0

Example2: Simple synchronous control is exercised with three pairs.

Assume that the following three pairs are to be used:

The master axis is the first axis, while a slave axis is the sixth axis.

The master axis is the second axis, while a slave axis is the fifth axis.

The master axis is the third axis, while a slave axis is the fourth axis.

For this specification, set this parameter as follows:

Parameter No.8311 X (First axis) = 0
 Y (Second axis) = 0
 Z (Third axis) = 0
 (Fourth axis) = 3
 (Fifth axis) = 2
 (Sixth axis) = 1

NOTE

The axis number of a master axis must always be smaller than the corresponding slave axis number. Multiple slave axes cannot be assigned to a master axis.

8312	Enabling/disabling mirror image in synchronous control
------	--

[Data type] Byte axis

[Valid data range] -127 to +128

This parameter sets the mirror image function. When 100 or a greater value is set with this parameter, the mirror image function is applied to synchronous control. Set this parameter to the slave axis.

Example

To establish reversed synchronization when using the third axis as the master axis and the fourth axis as the slave axis, set parameter No.8311 and parameter No.8312 as follows:

Parameter No.8311 (first axis) = 0
 Parameter No.8311 (second axis) = 20
 Parameter No.8311 (third axis) = 0
 Parameter No.8311 (fourth axis) = 0
 Parameter No.8312 (first axis) = 0
 Parameter No.8312 (second axis) = 0
 Parameter No.8312 (third axis) = 0
 Parameter No.8312 (fourth axis) = 100

8313	
	Limit of the difference between the amount of positioning deviation of the master and slave axes (Synchronous control one pair)

[Data type] Word

[Unit of data] Detection unit

[Valid data range] 0 to 32767

Set the limit of the difference between the amount of positioning deviation of the master and slave (fourth) axes. If the difference between them exceeds the limit assigned to the parameter, the P/S alarm (No.213) is activated.

8314	
	Maximum error in synchronization error check

[Data type] Word axis

[Unit of data]

Increment system	IS-A	IS-B	IS-C	Units
Millimeter machine	0.01	0.001	0.0001	mm
Inch machine	0.001	0.0001	0.00001	inch
Rotation axis	0.01	0.001	0.0001	deg

[Valid data range] 0 to 32767

The machine coordinates on a master axis and slave axis are monitored. If a difference (synchronization error) which is greater than the value specified in this parameter is detected, a servo alarm (No.407) is generated, and the machine is stopped.

Set this parameter with a master axis. When 0 is set in this parameter, no synchronization error check is made.

8315	
	Maximum compensation value for synchronization (Synchronous control one pair)

NOTE

When this parameter is set, the power must be turned off before operation is continued.

[Data type] Word axis

[Unit of data] Unit used for the detection

[Valid data range] 0 to 32767

This parameter sets the maximum compensation value for synchronization. When a compensation value greater than the value set in this parameter is used, servo alarm No.410 of slave axis is issued.

8316	
	Difference between reference counters for master and slave axes (Synchronous control one pair)

NOTE

When this parameter is set, the power must be turned off before operation is continued.

[Data type] 2-word

[Data unit] Detection unit

[Valid data range] -99999999 to 99999999

This parameter indicates the difference between the values in the reference counter for the master axis and that for the slave axis.

NOTE

Once grid positioning has been completed, the difference between the reference counters is automatically set in this parameter. At this time, bit 1 (ATS) of parameter No.8302 is set to 0.

8317	
	Torque difference alarm detection time (Synchronous control one pair)

[Data type] Word

[Data unit] ms

[Valid data range] 0 to 4000 (When 0 is set, 512 ms is assumed.)

This parameter specifies the period between the servo preparation completion signal (SA <F000 bit 6>) being set to 1 and the check of the torque difference alarm being started, for the torque difference alarm detection function.

The set value is rounded up to the nearest a multiple of 16 ms.

[Example]

When 100 is specified, 112 ms is assumed.

8318	Detection timer for the limit of the difference between the positioning deviation of the master axis and that of the slave axis
------	---

[Data type] Word

[Unit of data] 8m

[Valid data range] 0 to 1000

This parameter sets the time from the output of a compensation pulse to the slave axis to the start of the check of the limit of the difference between the positioning deviation of the master axis and that of the slave axis by the synchronization function. The setting is also used for the check of an excessive error at stop.

NOTE

If a value greater than 1000 is set, a value of 1000 is assumed.

8323	Maximum allowable difference between master axis and slave axis positional deviations
------	---

[Data type] Word axis

[Unit of data] Detection unit

[Valid data range] 0 to 32767

This parameter sets the maximum allowable difference between the master axis and slave axis position deviations. If a positional deviation difference exceeds the value specified in this parameter, an alarm (No.213) is issued.

Set this parameter with a master axis. If 0 is specified in this parameter, no position deviation difference check is made.

8325	Maximum compensation value for synchronization
------	--

[Data type] Word axis

[Unit of data] Detection unit

[Valid data range] 0 to 32767

This parameter sets the maximum compensation value for synchronization. If a compensation value exceeds the value specified with this parameter, a servo alarm (No.407) is issued.

Specify a master axis for this parameter. To enable this parameter, set the SOFx parameter (bit 7 of parameter No.8303) to 1.

8326	
	Difference between master axis and slave axis reference counters

[Data type] 2-word axis

[Unit of data] Detection unit

[Valid data range] -99999999 to 99999999

The difference between the master axis reference counter and slave axis reference counter (master axis and slave axis grid shift) is automatically set when automatic setting for grid positioning is performed. Then, the difference is transferred together with an ordinary grid shift value to the servo system when the power is turned on.

This parameter is set with a master axis.

8327	
	Torque difference alarm detection timer

[Data type] Word axis

[Unit of data] ms

[Valid data range] 0 to 4000

This parameter sets a time from the servo preparation completion signal, SA (F000#6), being set to 1 until torque difference alarm detection is started in simple synchronous control. A fraction of less than 16 msec is rounded up.

Example: Setting = 100: The specification of 112 msec is assumed.

Set this parameter with a master axis. If 0 is set in this parameter, the specification of 512 msec is assumed.

4.70 PARAMETERS OF CHECK TERMINATION

8341

Program number subject to check termination

[Data type] Word

[Valid data range] 0 to 9999

This parameter sets the program number, including a sequence number, subject to sequence number check termination. Parameter No.8342 is used to set a sequence number subject to check termination.

NOTE

A program number can also be set on the setting screen. If a program number is set on the setting screen, the value of the parameter is changed accordingly.

8342

Sequence number subject to check termination

[Data type] 2-word

[Valid data range] 0 to 9999

This parameter sets the sequence number subject to sequence number check termination.

If the block containing the sequence number set with this parameter is executed while the program set with parameter No.8341 is being executed, a single block stop occurs after the block is executed. At this time, the setting is automatically set to -1. Upon power-up, the setting is automatically set to 0.

NOTE

A sequence number can also be set by using the setting screen. If a sequence number is set on the setting screen, the value of the parameter is changed accordingly.

8343

Program number where collation is to be stopped (when an 8-digit program number is used)

[Data type] 2-word

[Valid data range] 0 to 99999999

When a sequence number check is to be stopped, this parameter sets the program number to which a sequence number where the check is to be stopped belongs. Set a stop sequence number in parameter No.8342.

4.71 PARAMETERS OF CHOPPING

	#7	#6	#5	#4	#3	#2	#1	#0
8360								
	CHF					CVC		ROV

[Data type] Bit

ROV For the chopping function, a rapid traverse override for a section from the current position to the R point is determined as follows:

0 : A chopping override is enabled.

1 : An ordinary rapid traverse override is enabled.

CVC The feedrate along the chopping axis is changed:

0 : At the upper or lower dead point immediately after the feedrate change command is issued.

1 : At the upper dead point immediately after the feedrate change command is issued.

CHF On the chopping screen, the chopping speed can:

0 : Be set.

1 : Not be set.

	#7	#6	#5	#4	#3	#2	#1	#0
8361								
								CMX

[Data type] Bit

CMX When the amount of shortage at the lower dead point becomes smaller than the value set in parameter No. 8378, clamping at the maximum chopping feedrate:

0 : Continues.

1 : Is not performed.

NOTE

Because clamping at the maximum chopping feedrate is not performed, the final chopping feedrate may exceed the maximum chopping feedrate.

8370	
	Chopping axis

[Data type] Byte

[Valid data range] 1 to the number of controlled axes

This parameter specifies which servo axis the chopping axis corresponds to.

8371	
	Chopping reference point (R point)
8372	
	Chopping upper dead point
8373	
	Chopping lower dead point

[Data type] 2-word

[Valid data range]

Increment system	IS-A	IS-B	IS-C	Unit
Metric machine	0.01	0.001	0.0001	mm
Inch machine	0.001	0.0001	0.00001	inch
Rotation axis	0.01	0.001	0.0001	deg

[Valid data range] -99999999 to 99999999

The data set in these parameters are absolute coordinates.

8374	
	Chopping speed

[Data type] 2-word

[Unit of data]

Increment system	Unit
Linear axis (metric input)	1.00 mm/min
Linear axis (inch input)	0.01 inch/min

Valid data range : For IS-A and -B, 240000 mm/min or 9600 inches/min
For IS-C, 100000 mm/min or 4800 inches/min

8375	
	Maximum chopping feedrate

[Data type] 2-word

[Unit of data]

[Valid data range]

Increment system	Unit of data	Valid data range	
		IS-A, IS-B	IS-C
Metric machine	1 mm/min	30 to 240000	30 to 100000
Inch machine	0.1 inch/min	30 to 96000	30 to 48000
Rotation axis	1 deg/min	30 to 240000	30 to 100000

The chopping speed is clamped at a value specified in this parameter. When the parameter is 0, no chopping operation occurs.

8376	
	Chopping compensation scaling factor

[Data type] Byte

[Unit of data] %

[Valid data range] 0 to 100

This parameter specifies a scaling factor used to multiply the compensation value for a servo delay or acceleration/deceleration delay in an chopping operation. When this parameter is 0, servo delay compensation will not be applied.

8377	
	Compensation start tolerance

[Data type] Word

[Unit of data]

Increment system	IS-A	IS-B	IS-C	Unit
Metric machine	0.01	0.001	0.0001	mm
Inch machine	0.001	0.0001	0.00001	inch
Rotation axis	0.01	0.001	0.0001	deg

[Valid data range] 0 to 32767

Compensation is applied when the difference between an amount of shortage at the upper dead point and that at the lower dead point is less than the value specified in this parameter. In other words, this parameter is used to enable compensation after the chopping operation settles. When the parameter is 0, compensation will not be applied.

8378	
	Amount of an error permissible for starting increase in speed

[Data type] 2-word

[Unit of data]

Increment system	IS-A	IS-B	IS-C	Unit
Metric machine	0.01	0.001	0.0001	mm
Inch machine	0.001	0.0001	0.00001	inch
Rotation axis	0.01	0.001	0.0001	deg

[Valid data range] 0 to 99999999

This parameter sets the amount of an error permissible for starting increase in speed.

When the amount of shortage at the lower dead point becomes smaller than the value set in this parameter, clamping at the maximum chopping feedrate is not performed.

4.72 PARAMETERS OF HIGH-SPEED HIGH-PRECISION CONTOUR CONTROL BY RISC (M SERIES)

4.72.1

Parameters of Acceleration and Deceleration before Interpolation

8400	
	Parameter1 for determining a linear acceleration/deceleration before interpolation

[Data type] 2-word
[Unit of data]
[Valid range]

Increment system	Unit	Valid range	
		IS-B	IS-C
Millimeter machine	1 mm/min	10 to 240000	1 to 24000
Inch machine	0.1 inch/min	10 to 240000	1 to 24000
Rotation axis	1 deg/min	10 to 240000	1 to 24000

This parameter determines a linear acceleration and deceleration before interpolation. Usually, set the maximum cutting speed (parameter No.1422).

8401	
	Parameter2 for determining a linear acceleration/deceleration before interpolation

[Data type] Word
[Unit of data] ms
[Valid range] 0 to 4000

This parameter specifies the time required until the speed specified in parameter 1 is achieved.

When the bell-shaped acceleration/deceleration before interpolation is used, the data specified in parameter 1 and parameter 2 determines the maximum acceleration of bell-shaped acceleration/deceleration before look ahead interpolation.

NOTE

The function for linear acceleration/deceleration before interpolation is canceled when either parameter No.8400 or 8401 is set to 0.

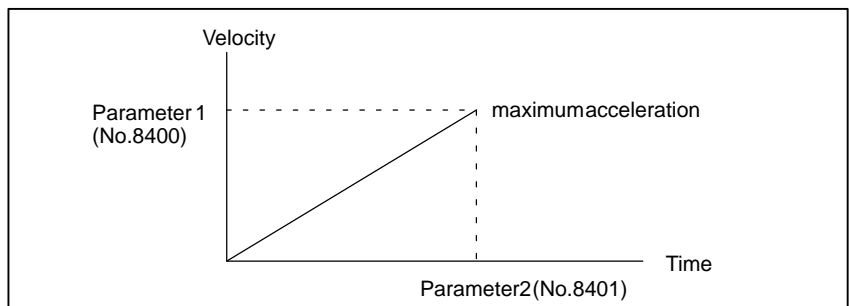

	#7	#6	#5	#4	#3	#2	#1	#0
8402								
	BDO		DST	BLK			NBL	

[Data type] Bit

NBL, BDO Select the type of acceleration/deceleration before interpolation.

BDO	NBL	Meaning
0	0	Linear type is used for acceleration/deceleration prior to pre-read interpolation
1	1	Bell-shape type is used for acceleration/deceleration prior to pre-read interpolation

BLK Be sure to set 0.

DST Be sure to set 1.

	#7	#6	#5	#4	#3	#2	#1	#0
8403								
	SGO				LM2	LM1	MSU	

[Data type] Bit

MSU When G00, or an M, S, T, or B code is specified in HPCC mode:

0 : An alarm is issued.

1 : The CNC executes the command.

LM1 In HPCC mode, a strokek check before movement for stored stroke limit 1 is:

0 : Not performed.

1 : Performed.

LM2 In HPCC mode, a strokek check before movement for the stored stroke limit is -2:

0 : Not performed.

1 : Performed.

SG0 When G00 is specified in HPCC mode:

0 : The setting of bit 1 (MSU) of parameter No.8403 is followed.

1 : The tool is moved along the axis at the feedrate set with parameter No.8481, replacing the G00 command with the G01 command, regardless of the setting made for bit 1 (MSU) of parameter No.8403.

	#7	#6	#5	#4	#3	#2	#1	#0
8404								
	RIT							STG

[Data type] Bit

STG The positioning command (G00) is:

0 : Executed with the RISC board in a simplified manner.

1 : Executed with the RISC board in the same way as normal.

NOTE

This parameter is enabled when the SG0 parameter (bit 7 of parameter No.8403) is set to 1.

RIT In high-precision contour mode, the axis-by-axis interlock function is:
 0 : Not enabled.
 1 : Enabled.

4.72.2 Parameters of Automatic Speed Control

8406	
	Lower limit of block movement time (for high-precision contour control)

[Data type] Byte

[Unit of data] ms

[Valid data range] 0 to 256

This parameter specifies the lower limit of block movement time during operation in the high-precision contour control mode. If the movement time of a cutting feed block is specified in this parameter, the maximum permissible speed is calculated from the programmed block movement time. If a specified feedrate exceeds this maximum permissible speed, the actual speed is automatically clamped to the maximum permissible speed.

8407	
	Lowest clamp speed of the deceleration function in accordance with the block movement time (for high-precision contour control)

[Data type] 2-word

[Unit of data, Valid data range]

Increment system	Unit of data	Valid data range	
		IS-B	IS-C
Millimeter machine	1 mm/min	6 to 15000	6 to 12000
Inch machine	0.1 inch/min	6 to 6000	6 to 4800
Rotation axis	1 deg/min	6 to 15000	6 to 12000

If the travel distance of a block is very short, the speed clamp function as specified by parameter No. 8406 may result in an extremely low speed. If the speed is lower than the value specified in this parameter, the actual speed is clamped to the speed specified in this parameter.

4.72.3 Parameters of Automatic Velocity Setting

8410	
	Allowable velocity difference in velocity determination considering the velocity difference at corners

[Data type] Word axis

[Unit of data]

[Valid range]

Increment system	Unit	Valid range	
		IS-B	IS-C
Millimeter machine	1 mm/min	10 to 60000	1 to 6000
Inch machine	0.1 inch/min	10 to 60000	1 to 6000
Rotation axis	1 deg/min	10 to 60000	1 to 6000

If zero specified for all axes, the machine does not decelerate at corners.

When the function for determining the velocity considering the velocity difference at corners is used, the system calculates the feedrate whereby a change in the velocity element of each axis does not exceed this parameter value at the interface between blocks. Then the machine decelerates using acceleration/deceleration before interpolation.

8412	#7	#6	#5	#4	#3	#2	#1	#0
			FDI				HIK	EST

[Data type] Bit

EST The simple NURBS interpolation start function is:

0 : Disabled.

1 : Enabled.

HIK The high-precision knot command of NURBS interpolation is:

0 : Disabled.

1 : Enabled.

FDI Parametric feedrate control of NURBS interpolation is:

0 : Disabled.

1 : Enabled.

8416	
	Look-ahead bell-shaped acceleration/deceleration before interpolation

[Data type] 2-word

[Unit of data] ms

[Valid range] 0 to 99999999

This parameter sets the time required to reach the feedrate set with parameter No.8400 or No.8401 in look-ahead bell-shaped

	#7	#6	#5	#4	#3	#2	#1	#0
8451								
	NOF			ZAG				USE

Setting point

[Data type] Bit

USE Automatic velocity control is:

0 : Not applied.

1 : Applied.

ZAG The velocity is:

0 : Not determined according to the angle at which the machine descends along the Z-axis.

1 : Determined according to the angle at which the machine descends along the Z-axis.

NOF In a block where automatic velocity control is validated, the F command is:

0 : Validated.

1 : Ignored.

8452	
	Range of velocity fluctuation to be ignored

Setting input

[Data type] Byte

[Unit of data] %

[Valid range] 0 to 100 (Standard setting: 10)

8456	
	Area-2 override

[Data type] Word

[Unit of data] %

[Valid range] 0 to 100 (Standard setting: 80)

This parameter specifies an override in area 2 of velocity calculation considering the cutting load.

8457	
	Area-3 override

[Data type] Word

[Unit of data] %

[Valid range] 0 to 100 (Standard setting: 70)

This parameter specifies an override in area 3 of velocity calculation considering the cutting load.

8458	
	Area-4 override

[Data type] Word

[Unit of data] %

[Unit of data] 0 to 100 (Standard setting: 60)

This parameter specifies an override in area 4 of velocity calculation considering the cutting load.

8459	#7	#6	#5	#4	#3	#2	#1	#0
							CTY	CDC

[Data type] Bit

CDC Be sure to set to 0.

CTY Be sure to set to 1.

8464	
	Initial feedrate for automatic feedrate control

[Data type] 2-word

[Unit of data and valid range]

Increment system	Unit	Valid range	
		IS-B	IS-C
Millimeter machine	1 mm/min	10 to 240000	1 to 100000
Inch machine	0.1 inch/min	10 to 96000	1 to 48000
Rotation axis	1 deg/min	10 to 240000	1 to 100000

This parameter sets the initial feedrate for automatic feedrate control.

In automatic feedrate control, the initial feedrate set with this parameter is used at the beginning if no F command is specified in the program. Usually, set the maximum cutting feedrate (specified in parameter No.1422).

8465	
	Maximum allowable feedrate for automatic feedrate control

[Data type] 2-word

[Unit of data and valid range]

Increment system (Input unit)	Unit	Valid range	
		IS-B	IS-C
Metric input	1 mm/min	10 to 240000	1 to 100000
Inch input	0.1 inch/min	10 to 96000	1 to 48000
Rotation axis	1 deg/min	10 to 240000	1 to 100000

This parameter sets the maximum allowable feedrate for automatic feedrate control. Usually, set the maximum allowable cutting feedrate (set in parameter No.1422).

The maximum cutting feedrate is clamped at the value set in parameter No. 1422.

8470	
	Parameter for determining allowable acceleration in velocity calculation considering acceleration

[Data type] Word axis

[Unit of data] ms

[Valid range] 0 to 32767

When the function for calculating the velocity considering the acceleration is used under automatic velocity control, this parameter is used to determine the allowable acceleration. The time required until the maximum cutting speed (parameter No.1422) is reached must be specified here.

8475	#7	#6	#5	#4	#3	#2	#1	#0
					CIR	BIP		

[Data type] Bit

CIR The function of automatic velocity control considering acceleration and deceleration during circular interpolation is:

0 : Not used.

1 : Used.

NOTE

When 1 is set, parameter No.8470 for determining the allowable acceleration must be specified.

BIP The function of deceleration at corners is:

0 : Not used.

1 : Used. (Always set 1.)

8480	#7	#6	#5	#4	#3	#2	#1	#0
		RI2	RI1	RI0				

NOTE

When this parameter is set, the power must be turned off before operation is continued.

[Data type] Bit

RI2, RI1, RI0 Always set the following values.

RI2	RI1	RI0
Setting	0	0
	0	1

8481	
	Rapid traverse rate in HPCC mode

[Data type] 2-word

[Unit of data and valid range]

Increment system	Unit	Valid range	
		IS-B	IS-C
Millimeter machine	1 mm/min	0 to 600000	0 to 60000
Inch machine	0.1 inch/min	0 to 600000	0 to 60000
Rotation axis	1 deg/min	0 to 600000	0 to 60000

When bit 7 (SG0) of parameter No.8403 is set to 1, this parameter sets the rapid traverse rate in the HPCC mode.

NOTE

The G00 command is replaced with the G01 command before execution. So, even if feedrate is specified for two axes, the rapid traverse rate set with this parameter is always used.

[Example]

If the following command is specified when a rapid traverse rate of 1000 mm/min is set F1000, rather than F1414, is used:
G00 X100.Y100.;

8485	#7	#6	#5	#4	#3	#2	#1	#0
			CDS	INV	PRW	GO2	G81	G51

[Data type] Bit

- G51** In high-precision contour control (HPCC) mode, scaling/coordinate system rotation is:
0 : Disabled.
1 : Enabled.
- G81** In high-precision contour control (HPCC) mode, a hole machining canned cycle is:
0 : Disabled.
1 : Enabled.
- G02** In high-precision contour control (HPCC) mode, helical interpolation is:
0 : Disabled.
1 : Enabled.
- PRW** In high-precision contour control (HPCC) mode, parameter rewriting using the PMC window is:
0 : Disabled.
1 : Enabled.
- INV** In high-precision contour control (HPCC) mode, involute interpolation is:
0 : Disabled.
1 : Enabled.
- CDS** In high-precision contour control (HPCC) mode, smooth interpolation is:
0 : Disabled.
1 : Enabled.

8486	
	Maximum travel distance of a block where smooth interpolation is applied

[Data type] 2-word

[Unit of data] Least input increment (depending on the set reference axis)

[Valid data range] 0 to 99999999

This parameter specifies a block length used as a reference to decide whether to apply smooth interpolation. If the line specified in a block is longer than the value set in the parameter, smooth interpolation will not be applied to that block. This parameter can be used, for example, to specify the maximum line length of a folded line to which a metal die workpiece is approximated with some tolerance.

8487	
	Angle at which smooth interpolation is turned off

[Data type] Word

[Unit of data] 0.1 deg

[Valid data range] 0 to 32767

This parameter sets the angle used to determine whether to apply smooth interpolation.

At a point having a difference in angle greater than this setting, smooth interpolation is turned off.

NOTE

If a value of 0 is set, the setting is assumed to be 10 degrees.

8490	
	Minimum travel distance of a block where smooth interpolation is applied

[Data type] 2-word

[Unit of data]

Increment system	IS-B	IS-C	Unit
Metric input	0.001	0.0001	mm
Inch input	0.0001	0.00001	inch

[Valid data range] 0 to 99999999

This parameter sets a block length used to determine whether to apply smooth interpolation.

If the line specified in a block is shorter than the value set in this parameter, smooth interpolation is not applied to that block.

8491	
	Maximum tolerance for a block where smooth interpolation is applied
8492	
	Minimum tolerance for a block where smooth interpolation is applied

[Data type] Word

[Unit of data]

Increment system	IS-B	IS-C	Unit
Metric input	0.001	0.0001	mm
Inch input	0.0001	0.00001	inch

[Valid data range] 0 to 32767

These parameters set the maximum and minimum tolerances used to determine whether to apply smooth interpolation. If the tolerance specified in a block is larger or smaller than these settings, smooth interpolation is not applied to that block.

Usually, set about one-tenth of the setting for the maximum tolerance (No. 8491) for the minimum tolerance (No. 8492).

Reference: Tolerance means the distance between curve C which smoothly connects the specified points and line L.

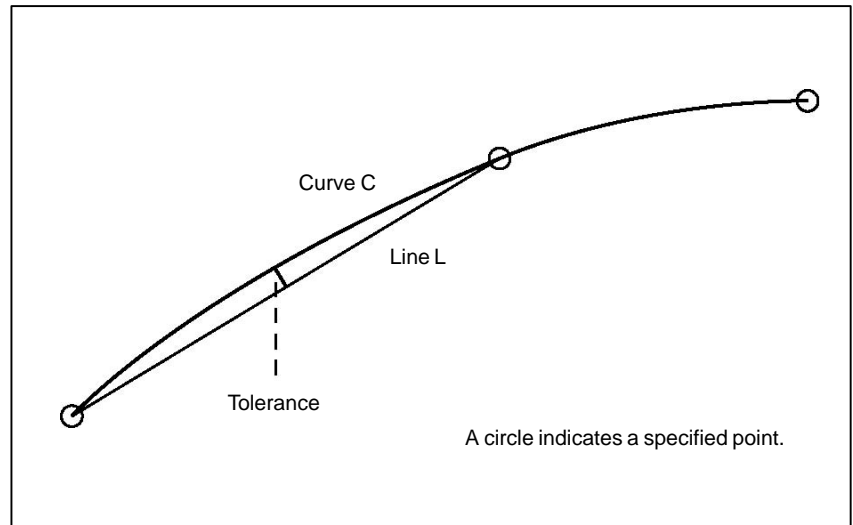

NOTE

If a value of 0 is set for the minimum tolerance (No. 8492), the minimum tolerance is assumed to be one-tenth of the maximum tolerance (No. 8491).

If a negative value is set for the minimum tolerance (No. 8492), the minimum tolerance (No. 8492) is assumed to be 0.

4.72.4

Parameters of Axis Control

7510	Maximum number of axes controlled by RISC
------	---

[Data type] Byte

[Valid range] 1, 2, 3, ... to the maximum number of control axes

This parameter specifies the maximum number of axes to be controlled by RISC.

[Example]

Six axes are provided. Starting from the first axis, they are the X-axis, Y-axis, Z-axis, A-axis, B-axis, and C-axis. To control the fourth axis (A-axis) by RISC, specify 4. When 4 is specified, X-, Y-, and Z-axes are also controlled by RISC.

X-, Y-, Z-, and A-axes: Controlled by RISC

B- and C-axes: Not controlled by RISC

4.73 PARAMETERS OF HIGH-SPEED POSITION SWITCHES (1/2)

	#7	#6	#5	#4	#3	#2	#1	#0
8500	EPS							

[Data type] Bit

EPS The maximum number of high-speed position switches is:
 0 : 6.
 1 : 16.

	#7	#6	#5	#4	#3	#2	#1	#0
8501								HPO

NOTE

When this parameter has been set, the power must be turned off before operation is continued.

[Data type] Bit

HPO The output signal of a high-speed position switch is output to:
 0 : Address Y. (See the explanation of parameter No. 8565.)
 1 : Address F. (PMC signal <F293 or F294>)

	#7	#6	#5	#4	#3	#2	#1	#0
8504	HE8	HE7	HE6	HE5	HE4	HE3	HE2	HE1

	#7	#6	#5	#4	#3	#2	#1	#0
8505	HEG	HEF	HEE	HED	HEC	HEB	HEA	HE9

[Data type] Bit

HE1 to HEG The corresponding high-speed position switch is:
 0 : Enabled.
 1 : Disabled.

1 to G of a bit name corresponds to the high-speed position switch place.
 These parameters specify whether to enable or disable the corresponding high-speed position switches.

A disabled high-speed position switch always outputs 0.

	#7	#6	#5	#4	#3	#2	#1	#0
8508	HM8	HM7	HM6	HM5	HM4	HM3	HM2	HM1
	#7	#6	#5	#4	#3	#2	#1	#0
8509	HMG	HMF	HME	HMD	HMC	HMB	HMA	HM9

NOTE

When this parameter has been set, the power must be turned off before operation is continued.

[Data type] Bit

HM1 to HMG The output type of the corresponding high-speed position switch is:
 0 : Normal. (The machine coordinate range is used to determine whether to output the signal.)
 1 : Decision by direction. (The machine coordinates and operation direction are used to determine whether to output the signal.)

Bit name HM1 to HMG corresponds to the high-speed position switch place.

These parameters set the output types for the corresponding high-speed position switches.

	#7	#6	#5	#4	#3	#2	#1	#0
8512	HA8	HA7	HA6	HA5	HA4	HA3	HA2	HA1
	#7	#6	#5	#4	#3	#2	#1	#0
8513	HAG	HAF	HAE	HAD	HAC	HAB	HAA	HA9

[Input type] Parameter input**[Data type]** Bit

HA1 to HAG The signal is turned on when the corresponding high-speed position switch passes through the machine coordinate position set in parameter No. 8580 to 8589 or 12221 to 12226:

0 : In the negative (–) direction.

1 : In the positive (+) direction.

Bit name HA1 to HAG corresponds to the high-speed position switch place.

When decision by direction is selected for the output type of a high-speed position switch in parameter No. 8508 or 8509, the corresponding parameter sets the direction.

	#7	#6	#5	#4	#3	#2	#1	#0
8516	HB8	HB7	HB6	HB5	HB4	HB3	HB2	HB1
	#7	#6	#5	#4	#3	#2	#1	#0
8517	HBG	HBF	HBE	HBD	HBC	HBB	HBA	HB9

[Data type] Bit

HB1 to HBG The signal is turned off when the corresponding high-speed position switch passes through the machine coordinate position set in parameter No. 8590 to 8599 or 12241 to 12246:

0 : In the negative (-) direction.

1 : In the positive (+) direction.

Bit name HB1 to HBG corresponds to the high-speed position switch place.

When decision by direction is selected for the output type of a high-speed position switch in parameter No. 8508 or 8509, the corresponding parameter sets the direction.

8565	Output address of the high-speed position switch signal
------	---

NOTE

When this parameter has been set, the power must be turned off before operation is continued.

[Data type] Word

[Valid data range] 0, 1 to 127, 1000 to 1014, 1020 to 1034

This parameter sets the address of the Y signal which outputs the high-speed position switch signal.

This parameter is valid when bit 0 (HPO) of parameter No. 8501 is set to 0.

8570	Axis corresponding to the first high-speed position switch
8571	Axis corresponding to the second high-speed position switch
8572	Axis corresponding to the third high-speed position switch
8573	Axis corresponding to the fourth high-speed position switch
8574	Axis corresponding to the fifth high-speed position switch
8575	Axis corresponding to the sixth high-speed position switch
8576	Axis corresponding to the seventh high-speed position switch
8577	Axis corresponding to the eighth high-speed position switch
8578	Axis corresponding to the ninth high-speed position switch
8579	Axis corresponding to the tenth high-speed position switch

[Data type] Byte

[Valid data range] 0 to Number of controlled axes

These parameters specify the axis control numbers corresponding to the first to tenth high-speed position switches.

NOTE

Set 0 for the number corresponding to a high-speed position switch which is not to be used.

8580	Maximum operation range of the first high-speed position switch
8581	Maximum operation range of the second high-speed position switch
8582	Maximum operation range of the third high-speed position switch
8583	Maximum operation range of the fourth high-speed position switch
8584	Maximum operation range of the fifth high-speed position switch
8585	Maximum operation range of the sixth high-speed position switch
8586	Maximum operation range of the seventh high-speed position switch
8587	Maximum operation range of the eighth high-speed position switch
8588	Maximum operation range of the ninth high-speed position switch
8589	Maximum operation range of the tenth high-speed position switch

[Data type] 2-word

[Unit of data]

Increment system	IS-A	IS-B	IS-C	Unit
Metric machine	0.01	0.001	0.0001	mm
Inch machine	0.001	0.0001	0.00001	inch
Rotation axis	0.01	0.001	0.0001	deg

[Valid data range] -99999999 to 99999999

These parameters set the maximum operation ranges of the first to tenth high-speed position switches.

8590	Minimum operation range of the first high-speed position switch
8591	Minimum operation range of the second high-speed position switch
8592	Minimum operation range of the third high-speed position switch
8593	Minimum operation range of the fourth high-speed position switch
8594	Minimum operation range of the fifth high-speed position switch
8595	Minimum operation range of the sixth high-speed position switch
8596	Minimum operation range of the seventh high-speed position switch
8597	Minimum operation range of the eighth high-speed position switch
8598	Minimum operation range of the ninth high-speed position switch
8599	Minimum operation range of the tenth high-speed position switch

[Data type] 2-word

[Unit of data]

Increment system	IS-A	IS-B	IS-C	Unit
Metric machine	0.01	0.001	0.0001	mm
Inch machine	0.001	0.0001	0.00001	inch
Rotation axis	0.01	0.001	0.0001	deg

[Valid data range] -99999999 to 99999999

These parameters set the minimum operation ranges of the first to tenth high-speed position switches.

4.74 OTHER PARAMETERS

	#7	#6	#5	#4	#3	#2	#1	#0
8650			PGU				CNA	RSK

[Data type] Bit

RSK When the RESET key is pressed, the key code is:

- 0 : Not passed to the application.
- 1 : Passed to the application.

CNA When an NC alarm is issued during the display of the user screen for the C executor:

- 0 : The NC alarm screen can be displayed depending on the setting of bit 7 (NPA) of parameter No.3111.
- 1 : The NC alarm screen is not displayed.

NOTE

This parameter is used with the C executor. Any modifications to the value set for this parameter does not become effective until after the system is next powered on.

PGU When the user screen for the C executor is assigned as an NC program screen:

- 0 : The common screen number is used.
- 1 : The screen number for each operation mode is used.

	#7	#6	#5	#4	#3	#2	#1	#0
8651								CFS

NOTE

When this parameter has been set, the power must be turned off before operation is continued.

[Data type] Bit

CFS FACTOLINK software in:

- 0 : Dedicated memory card is valid.
- 1 : FROM is valid.

8661	Variable area size
------	--------------------

[Data type] Word

[Unit of data] KByte

[Valid data range] 0 to 59 (251)

This parameter specifies the size of the static variable area that can be shared by tasks of C executor. The maximum size is 59K bytes (251K bytes if an optional 256KB SRAM is added). The total of the SRAM disk size (parameter No. 8662) and the value of this parameter should not exceed the available SRAM size minus 1K bytes (that is, 63K or 255K bytes).

NOTE

This parameter is used for C executer. When this setting is changed, the variable area is initialized. A change in this setting is applied at the next power-up or later.

8662

SRAM disk size

[Data type] Word

[Unit of data] KByte

[Valid data range] 4 to 63 (255)

This parameter specifies the SRAM disk size in C executer. Specify a value greater than or equal to 4K bytes in 1K-byte units. The maximum size is 63K bytes (255K bytes if the optional 256KB SRAM is added). The total of the variable area size (parameter No. 8661) and the value of this parameter should not exceed the available SRAM size minus 1K bytes (that is, 63K or 255K bytes).

NOTE

This parameter is used for C executer. When this setting is changed, the SRAM disk is initialized. A change in this setting is applied at the next power-up or later.

8663

Time zone setting

[Data type] 2-word

[Unit of data] s

[Valid data range] $-12*3600$ to $12*3600$

This parameter specifies the time-zone difference from Greenwich Mean Time in seconds. The difference for Japan is -9 hours. (The setting is $-9*3600 = 32400$)

NOTE

This parameter is used for C executer. A change in this setting is applied at the next power-up or later.

8700

#7	#6	#5	#4	#3	#2	#1	#0
				DMM			

[Data type] Bit

DMM In DNC operation from the PMC, MMC, or C-EXE, pre-reading is:
 0 : Not performed.
 1 : Performed.

	#7	#6	#5	#4	#3	#2	#1	#0
8701		CTV				WPR	PLD	
						WPR	PLD	

[Data type] Bit

PLD When the P-code loader function is used (macro compiler/executor):
 0 : AM is initialized and the entire contents of RAM are rewritten.
 1 : RAM is not initialized, being overwritten instead

WPR The function that allows parameters that are rewritten using the PMC window to be enabled during automatic operation is:
 0 : Disabled.
 1 : Enabled.

CTV When CAP II is provided, 1 must be specified.

	#7	#6	#5	#4	#3	#2	#1	#0
8702	LFM							

[Data type] Bit

LFM At the beginning of program uploading in response to a request using the data window library:
 0 : "LF+%" is not output.
 1 : "LF+%" is output.

	#7	#6	#5	#4	#3	#2	#1	#0
8703							LCL	DLF

[Data type] Bit

DLF If an incomplete program file is created because program registration, performed via a communication board such as MAP is interrupted by a reset or alarm, the file is:
 0 : Not deleted.
 1 : Deleted.

NOTE

This parameter is used with the OSI/Ethernet function.

LCL When a change in the internal state of the CNC (such as a change in the number of part programs or selected programs) occurs, information about the change is:
 0 : Not sent to the host.
 1 : Sent to the host.

NOTE

This parameter is used with the OSI/Ethernet function.

	#7	#6	#5	#4	#3	#2	#1	#0
8706							NWD	HSD

NOTE

When this parameter has been set, the power must be turned off before operation is continued.

[Data type] Bit

- HSD** Main machining during DNC operation with FOCAS1/HSSB is:
 0 : Normal operation.
 1 : High-speed operation.

Set this parameter according to machining during DNC operation. Usually, when binary operation and programs containing contiguous small blocks are performed during DNC operation with FOCAS1/HSSB, high-speed operation is selected.

NOTE

For details of this parameter, also refer to “FANUC Open CNC DNC Operation Management Package” and other manuals.

- NWD** During DNC operation with FOCAS1/HSSB, new DNC functions are:
 0 : Not executed.
 1 : Executed.

When this parameter is set, the M198 command (subprogram call) can also be executed with FOCAS1/HSSB.

NOTE

To execute the M198 command with FOCAS1/HSSB, parameter No. 20 must be set to “15”.

For details of this parameter, also refer to “FANUC Open CNC DNC Operation Management Package” and other manuals.

8760

Program number for data registration (data input/output function using the I/O link)

[Data type] Word**[Valid data range]** 0 to 9999

When the data input/output function using the I/O link is used, this parameter sets the program numbers of the programs to be used for registering data (parameters, macro variables, and diagnostic data) from Power Mates.

For a Power Mate in group n , the following program numbers are used:

For parameters: Setting + $n \times 10 + 0$

For macro variables: Setting + $n \times 10 + 1$

For diagnostic data: Setting + $n \times 10 + 2$

Example: When 8000 is set

8000: Parameters of group 0 (I/O channel = 20)

8001: Macro variables of group 0 (I/O channel = 20)

8002: Diagnostic data of group 0 (I/O channel = 20)

8010: Parameters of group 1 (I/O channel = 21)

8011: Macro variables of group 1 (I/O channel = 21)

8012: Diagnostic data of group 1 (I/O channel = 21)

8020: Parameters of group 2 (I/O channel = 22)

8021: Macro variables of group 2 (I/O channel = 22)

8022: Diagnostic data of group 2 (I/O channel = 22)

8150: Parameters of group 15 (I/O channel = 35)

8151: Macro variables of group 15 (I/O channel = 35)

8152: Diagnostic data of group 15 (I/O channel = 35)

NOTE

When 0 is set, the input/output of parameters, macro variables, and diagnostic data cannot be performed, but program input/output processing is performed.

8781

Amount of DRAM used with the C executor

NOTE

When this parameter is set, the power must be turned off before operation is continued.

[Data type] Byte**[Unit of data]** 64k Byte**[Valid data range]** 16 to 64

This parameter sets the amount of DRAM to be used by the C executor. Specify a size of no less than 1024K bytes, in multiples of 64K bytes. If a value that exceeds the valid data range is specified, 0 is assumed.

NOTE

The available size depends on the amount of installed DRAM and the selected options.

8790	Timing for executing an auxiliary macro
------	---

[Data type] Word

[Unit of data]

This parameter sets the timing for executing a macro executor auxiliary macro while NC programs, offset data, and so forth are being read or punched out.

When as many characters as the number specified with this parameter are read or punched out, an auxiliary macro is executed once. When 0 is set in this parameter, no auxiliary macro is executed during read or punch processing.

	#7	#6	#5	#4	#3	#2	#1	#0
8801								

[Data type] Bit

Bit parameter 1 for machine tool builder

	#7	#6	#5	#4	#3	#2	#1	#0
8802								

[Data type] Bit

Bit parameter 2 for machine tool builder

NOTE

These parameters are used only by the machine tool builder. Refer to the relevant manual supplied by the machine tool builder for details.

8811	2-word parameter 1 for machine tool builder
8812	2-word parameter 2 for machine tool builder
8813	2-word parameter 3 for machine tool builder

[Data type] 2-word

[Valid data range] -99999999 to 99999999

NOTE

These parameters are used only by the machine tool builder. Refer to the relevant manual supplied by the machine tool builder for details.

4.75 PARAMETERS OF MAINTENANCE

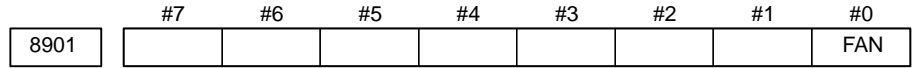

[Data type] Bit

FAN A fan motor error is:
 0 : Detected. (When the fan motor error is detected, an overheating alarm occurs.)
 1 : Not detected. (Use inhibited)

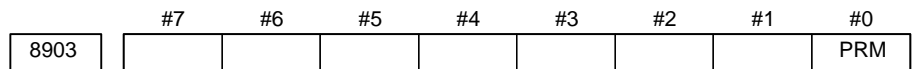

[Data type] Bit

PRM A periodic maintenance expiration message is:
 0 : Not displayed.
 1 : Displayed.

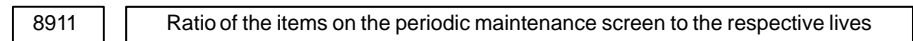

[Data type] Byte

[Unit of data] 1%

[Valid data range] 0 to 100

On the periodic maintenance screen, if the remaining time of an item falls to a value less than the percentage of the life specified in this parameter, the remaining time is displayed in red as a warning.

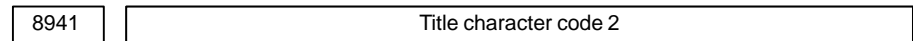
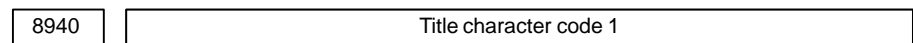

:

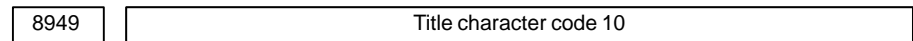

[Data type] Byte

[Valid data range] See below.

When the CNC is turned on, up to ten characters specified in these parameters are displayed on the screen showing the series and edition of the CNC.

- The following characters can be used.
 0 to 9, A to Z, - (minus sign), . (period), and space
- The character codes to be specified are listed in the character code list in Appendix A.
- If any code other than those character codes that can be specified is specified, a space is displayed.

4.76 PARAMETERS OF BUILT-IN MACRO

	#7	#6	#5	#4	#3	#2	#1	#0
12001								IMR

[Data type] Bit

- IMR** If an attempt is made to enter a program having the same program number as a built-in macro program that has already been entered,
- 0: An alarm is raised.
- 1: The built-in program is deleted, then the new program is entered. However, if the built-in program is edit-prohibited, the program is not deleted, but an alarm is raised.

REP (Prm.No.3201#2)	IMREP (Prm.No.12001#0)	Program stored on tape	Built-in macro program
0	0	Alarm	Alarm
0	1	Alarm	Overwrite
1	0	Overwrite	Alarm
1	1	Overwrite	Overwrite

NOTE

- 1 This parameter is rewritten by the built-in macro data in FROM at power-up or at a reload operation.
- 2 If the key of parameter No. 12013 is locked, the built-in macro data in FROM is used.

12010	Built-in macro program referencing or editing enabled/disabled
-------	--

[Data type] Byte

[Valid data range] 0 to 2

This parameter specifies whether referencing or editing of a built-in macro program is enabled or disabled.

Prm.No.12010	Edit	Reference
0	×	×
1	×	○
2	○	○

NOTE

- 1 This parameter is rewritten by the built-in macro data in FROM at power-up or at a reload operation.
- 2 If the key of parameter No. 12013 is locked, the built-in macro data in FROM is used.

12011	First built-in macro program number
12012	Last built-in macro program number

[Data type] 2-word

[Valid data range] 1 to 99999999

These parameters specify built-in macro programs by specifying the first and last program numbers. The other programs are part program storage programs.

Example: Sample four-digit program numbers

Parameter No.12011=1234

Parameter No.12012=5678

↓

Built-in macro program number = O1234 to O5678

Part program storage program number = O0001 to O1233

O5679 to O9999

NOTE

- 1 This parameter is rewritten by the built-in macro data in FROM at power-up or at a reload operation.
- 2 If the key of parameter No. 12013 is locked, the built-in macro data in FROM is used.
- 3 This parameter cannot be changed if a key for built-in macro is locked or if at least a single NC program is provided.

12013	Password/keyword for built-in macro
-------	-------------------------------------

[Data type] 2-word

[Valid data range] -99999999 to 99999999

A password is specified to store a built-in macro program in FROM. After the built-in macro program is stored, this parameter is set to 0.

Otherwise, this parameter is used as a keyword input area. (After power-up, this parameter is set to 0.)

If the password matches the keyword, the key for built-in macro is unlocked. If the password does not match the keyword, the key for built-in macro is locked. If the password is 0 and if FROM does not include INMC, the key for built-in macro is unlocked, irrespective of the keyword.

- If locked, a built-in macro program cannot be saved. As the data items of 1 to 5 listed below, the corresponding data items of built-in macro in FROM are used.
- If unlocked, a built-in macro program can be saved. As the data items of 1 to 5 listed below, the corresponding parameter settings are used.
 1. Built-in macro program entry and overwrite disabled (bit 0 of parameter No. 12001)
 2. Built-in macro program referencing and editing enabled/disabled (parameter No. 12010)

3. Built-in macro program number (parameters No. 12011 and No. 12012)
4. Built-in macro series and edition (parameters No. 12015 and No. 12016)
5. Built-in macro G code and relative program number (parameters No. 12020 to No. 12049)

NOTE

- 1 If the password is not zero, the password cannot be changed for the built-in macro data.
- 2 If all of the following conditions are satisfied, the keyword cannot be changed.
 - 1) A password is specified. (Password is not zero.)
 - 2) The macro program number range of the built-in data of FROM is different from the built-in macro program number range specified in the parameter.
 - 3) A program is entered.

12015	Series for built-in macro
12016	Edition for built-in macro

[Data type] Word

[Valid data range] 0 to 9999

These parameters specify the series and edition of the FROM file for built-in macro. The series and edition are placed in the FROM file when the built-in macro data is saved and can be checked on the system configuration screen.

NOTE

- 1 This parameter is rewritten by the built-in macro data in FROM at power-up or at a reload operation.
- 2 If the key of parameter No. 12013 is locked, the built-in macro data in FROM is used.
- 3 If this parameter is set to 0, the series or edition of the FROM file for built-in macro is not displayed on the system configuration screen.

12020	G code number for built-in macro (first set)
12023	G code number for built-in macro (second set)
12047	G code number for built-in macro (tenth set)

[Data type] Word

[Valid data range] 1 to 999

12021	Program number for built-in macro (first set)
12024	Program number for built-in macro (second set)
12048	Program number for built-in macro (tenth set)

[Data type] Word

[Valid data range] 1 to 99999999

12022	G code macro count for built-in macro (first set)
12025	G code macro count for built-in macro (second set)
12049	G code macro count for built-in macro (tenth set)

[Data type] Byte

[Valid data range] 1 to 255

These parameters specify G code macros for built-in macros. A G code, corresponding macro program number, and corresponding G code count are specified. Up to ten sets of these items can be specified. If identical G code numbers are found, the one in a younger set takes priority. If any of the G code number, macro program number, and count is 0, the set is invalid.

Example: Suppose that built-in macro program numbers are 7000 to 8999.

	First set	Second set	Third set
G code	No.12020=100	No.12023=150	No.12026=900
O number	No.12021=8000	No.12024=7500	No.12027=8300
Count	No.12022=10	No.12025=100	No.12028=30

If the parameters are specified as listed above,

The G codes from G100 to G109 correspond to O8000 to O8009.

The G codes from G150 to G249 correspond to O7500 to O7599.

The G codes from G900 to G929 correspond to O8300 to O8239.

NOTE

- 1 This parameter is rewritten by the built-in macro data in FROM at power-up or at a reload operation.
- 2 If the key of parameter No. 12013 is locked, the built-in macro data in FROM is used.

4.77 PARAMETERS OF HIGH-SPEED POSITION SWITCHES (2/2)

12201	Axis corresponding to the eleventh high-speed position switch
12202	Axis corresponding to the twelfth high-speed position switch
12203	Axis corresponding to the thirteenth high-speed position switch
12204	Axis corresponding to the fourteenth high-speed position switch
12205	Axis corresponding to the fifteenth high-speed position switch
12206	Axis corresponding to the sixteenth high-speed position switch

[Data type] Byte

[Valid data range] 0 to Number of controlled axes

These parameters set the axis control numbers corresponding to the 11th to 16th high-speed position switches.

NOTE

Set 0 for the number corresponding to a high-speed position switch which is not to be used.

12221	Maximum operation range of the eleventh high-speed position switch
12222	Maximum operation range of the twelfth high-speed position switch
12223	Maximum operation range of the thirteenth high-speed position switch
12224	Maximum operation range of the fourteenth high-speed position switch
12225	Maximum operation range of the fifteenth high-speed position switch
12226	Maximum operation range of the sixteenth high-speed position switch

[Data type] 2-word

[Unit of data]

Increment system	IS-A	IS-B	IS-C	Unit
Metric machine	0.01	0.001	0.0001	mm
Inch machine	0.001	0.0001	0.00001	inch
Rotation axis	0.01	0.001	0.0001	deg

[Valid data range] -99999999 to 99999999

These parameters set the maximum operation ranges of the 11th to 16th high-speed position switches.

12241	Minimum operation range of the eleventh high-speed position switch
12242	Minimum operation range of the twelfth high-speed position switch
12243	Minimum operation range of the thirteenth high-speed position switch
12244	Minimum operation range of the fourteenth high-speed position switch
12245	Minimum operation range of the fifteenth high-speed position switch
12246	Minimum operation range of the sixteenth high-speed position switch

[Data type] 2-word

[Unit of data]

Increment system	IS-A	IS-B	IS-C	Unit
Metric machine	0.01	0.001	0.0001	mm
Inch machine	0.001	0.0001	0.00001	inch
Rotation axis	0.01	0.001	0.0001	deg

[Valid data range] -99999999 to 99999999

These parameters set the minimum operation ranges of the 11th to 16th high-speed position switches.

4.78 PARAMETERS OF OPERATION HISTORY

12801	Number of a signal symbol table for selecting an operation history signal (01)
12802	Number of a signal symbol table for selecting an operation history signal (02)
12803	Number of a signal symbol table for selecting an operation history signal (03)
12804	Number of a signal symbol table for selecting an operation history signal (04)
12805	Number of a signal symbol table for selecting an operation history signal (05)
12806	Number of a signal symbol table for selecting an operation history signal (06)
12807	Number of a signal symbol table for selecting an operation history signal (07)
12808	Number of a signal symbol table for selecting an operation history signal (08)
12809	Number of a signal symbol table for selecting an operation history signal (09)
12810	Number of a signal symbol table for selecting an operation history signal (10)
12811	Number of a signal symbol table for selecting an operation history signal (11)
12812	Number of a signal symbol table for selecting an operation history signal (12)
12813	Number of a signal symbol table for selecting an operation history signal (13)
12814	Number of a signal symbol table for selecting an operation history signal (14)
12815	Number of a signal symbol table for selecting an operation history signal (15)
12816	Number of a signal symbol table for selecting an operation history signal (16)
12817	Number of a signal symbol table for selecting an operation history signal (17)
12818	Number of a signal symbol table for selecting an operation history signal (18)
12819	Number of a signal symbol table for selecting an operation history signal (19)
12820	Number of a signal symbol table for selecting an operation history signal (20)

[Data type] Byte

[Valid data range] 1 to 10

Set the number of a symbol table including a signal of which operation history is to be recorded for operation history channel (01) to (20) as follows:

- 1 : G0 to G255
- 2 : G1000 to G1255
- 3 : F0 to F255
- 4 : F1000 to F1255
- 5 : Y0 to Y127
- 6 : X0 to X127
- 7 : Y1000 to Y1063
- 8 : X1000 to X1063
- 9 : G2000 to G2255
- 10 : F2000 to F2255

12841	Number of a signal selected as an operation history signal (01)
12842	Number of a signal selected as an operation history signal (02)
12843	Number of a signal selected as an operation history signal (03)
12844	Number of a signal selected as an operation history signal (04)
12845	Number of a signal selected as an operation history signal (05)
12846	Number of a signal selected as an operation history signal (06)
12847	Number of a signal selected as an operation history signal (07)
12848	Number of a signal selected as an operation history signal (08)
12849	Number of a signal selected as an operation history signal (09)
12850	Number of a signal selected as an operation history signal (10)
12851	Number of a signal selected as an operation history signal (11)
12852	Number of a signal selected as an operation history signal (12)
12853	Number of a signal selected as an operation history signal (13)
12854	Number of a signal selected as an operation history signal (14)
12855	Number of a signal selected as an operation history signal (15)
12856	Number of a signal selected as an operation history signal (16)
12857	Number of a signal selected as an operation history signal (17)
12858	Number of a signal selected as an operation history signal (18)
12859	Number of a signal selected as an operation history signal (19)
12860	Number of a signal selected as an operation history signal (20)

[Data type] Word

[Valid data range] 0 to 255

Set the number of a signal of which operation history is to be recorded for operation history channel (01) to (20) with a value between 0 and 255.

	#7	#6	#5	#4	#3	#2	#1	#0
12881	RB7	RB6	RB5	RB4	RB3	RB2	RB1	RB0
	History record bit settings for an operation history signal (01)							
12882	RB7	RB6	RB5	RB4	RB3	RB2	RB1	RB0
	History record bit settings for an operation history signal (02)							
12883	RB7	RB6	RB5	RB4	RB3	RB2	RB1	RB0
	History record bit settings for an operation history signal (03)							
12884	RB7	RB6	RB5	RB4	RB3	RB2	RB1	RB0
	History record bit settings for an operation history signal (04)							
12885	RB7	RB6	RB5	RB4	RB3	RB2	RB1	RB0
	History record bit settings for an operation history signal (05)							
12886	RB7	RB6	RB5	RB4	RB3	RB2	RB1	RB0
	History record bit settings for an operation history signal (06)							
12887	RB7	RB6	RB5	RB4	RB3	RB2	RB1	RB0
	History record bit settings for an operation history signal (07)							
12888	RB7	RB6	RB5	RB4	RB3	RB2	RB1	RB0
	History record bit settings for an operation history signal (08)							
12889	RB7	RB6	RB5	RB4	RB3	RB2	RB1	RB0
	History record bit settings for an operation history signal (09)							
12890	RB7	RB6	RB5	RB4	RB3	RB2	RB1	RB0
	History record bit settings for an operation history signal (10)							
12891	RB7	RB6	RB5	RB4	RB3	RB2	RB1	RB0
	History record bit settings for an operation history signal (11)							
12892	RB7	RB6	RB5	RB4	RB3	RB2	RB1	RB0
	History record bit settings for an operation history signal (12)							
12893	RB7	RB6	RB5	RB4	RB3	RB2	RB1	RB0
	History record bit settings for an operation history signal (13)							
12894	RB7	RB6	RB5	RB4	RB3	RB2	RB1	RB0
	History record bit settings for an operation history signal (14)							
12895	RB7	RB6	RB5	RB4	RB3	RB2	RB1	RB0
	History record bit settings for an operation history signal (15)							

	#7	#6	#5	#4	#3	#2	#1	#0
12896	RB7	RB6	RB5	RB4	RB3	RB2	RB1	RB0
History record bit settings for an operation history signal (16)								
	#7	#6	#5	#4	#3	#2	#1	#0
12897	RB7	RB6	RB5	RB4	RB3	RB2	RB1	RB0
History record bit settings for an operation history signal (17)								
	#7	#6	#5	#4	#3	#2	#1	#0
12898	RB7	RB6	RB5	RB4	RB3	RB2	RB1	RB0
History record bit settings for an operation history signal (18)								
	#7	#6	#5	#4	#3	#2	#1	#0
12899	RB7	RB6	RB5	RB4	RB3	RB2	RB1	RB0
History record bit settings for an operation history signal (19)								
	#7	#6	#5	#4	#3	#2	#1	#0
12900	RB7	RB6	RB5	RB4	RB3	RB2	RB1	RB0
History record bit settings for an operation history signal (20)								

[Data type] Bit

RB7 to RB0 For the signal set in channel (01) to (20), of which operation history is to be recorded, the history of each bit is:

0 : Not recorded. (The history of this bit is not recorded.)

1 : Recorded. (The history of this bit is recorded.)

APPENDIX

A CHARACTER CODE LIST

Character	Code	Comment	Character	Code	Comment
A	065		6	054	
B	066		7	055	
C	067		8	056	
D	068		9	057	
E	069			032	Space
F	070		!	033	Exclamation mark
G	071		"	034	Quotation marks
H	072		#	035	Shape
I	073		\$	036	Dollar mark
J	074		%	037	Percent
K	075		&	038	Ampersand
L	076		'	039	Apostrophe
M	077		(040	Left parenthesis
N	078)	041	Right parenthesis
O	079		*	042	Asterisk
P	080		+	043	Positive sign
Q	081		,	044	Comma
R	082		-	045	Negative sign
S	083		.	046	Period
T	084		/	047	Slash
U	085		:	058	Colon
V	086		;	059	Semicolon
W	087		<	060	Left angle bracket
X	088		=	061	Equal sign
Y	089		>	062	Right angle bracket
Z	090		?	063	Question mark
0	048		@	064	Commercial at mark
1	049		[091	Left square bracket
2	050		¥	092	Yen mark
3	051]	093	Right square bracket
4	052		^	094	
5	053			095	Underline

[C]

Character Code List, 485

[D]

Description of Parameters, 7

Displaying Parameters, 1

[I]

Inputting and Outputting Parameters Through the Reader/Puncher Interface, 4

Inputting Parameters through the Reader/Puncher Interface, 6

[O]

Other Parameters, 465

Outputting Parameters through the Reader/Puncher Interface, 5

[P]

Parameter of canned Cycle for Drilling, 255

Parameter of Multiple Repetitive Canned Cycle, 261

Parameter of Thread Cutting Cycle, 261

Parameters Common to all Channels, 14

Parameters of Acceleration and Deceleration before Interpolation, 448

Parameters of Acceleration/ Deceleration Control, 77

Parameters of Angular Axis Control, 430

Parameters of Attitude Control, 403

Parameters of Automatic Tool Compensation (T Series) and Automatic Tool Length Compensation (M Series), 332

Parameters of Automatic Velocity Setting, 451

Parameters of Axis Control, 458

Parameters of Axis Control by PMC, 406

Parameters of Axis Control/ Increment System, 39

Parameters of B-Axis Control, 432

Parameters of Canned Cycles, 255

Parameters of Channel 1 (I/O CHANNEL=0), 15

Parameters of Channel 1 (I/O CHANNEL=1), 16

Parameters of Channel 2 (I/O CHANNEL=2), 17

Parameters of Channel 3 (I/O CHANNEL=3), 17

Parameters of Check Termination, 444

Parameters of Checking Interference between Tool Posts (Two-path Control), 414

Parameters of Chopping, 445

Parameters of Coordinates, 48

Parameters of Custom Macros, 312

Parameters of Data Server, 35

Parameters of Di/Do, 129

Parameters of Displaying Operation Time and Number of Parts, 351

Parameters of DNC1 Interface, 30, 32

Parameters of DNC1/DNC2 Interface, 20

Parameters of Exponential Interpolation, 305

Parameters of External Data Input/Output, 334

Parameters of Feedrate, 64

Parameters of Graphic Color, 349

Parameters of Graphic Display, 345

Parameters of Graphic Display/Dynamic Graphic Display, 345

Parameters of Grinding-wheel Wear Compensation, 254

Parameters of High-Speed High-Precision Contour Control by RISC (M series), 448

Parameters of High-Speed Machining (High-Speed Cycle Machining/High-Speed Remote Buffer), 382

Parameters of Indexing Index Table, 300

Parameters of Involute Interpolation, 302

Parameters of M-NET Interface, 23, 26

Parameters of Maintenance, 471

Parameters of Manual Handle Feed, Handle Interruption and Handle Feed in Tool Axial Direction, 369

Parameters of Manual Operation and Automatic Operation, 364

Parameters Of Mdi, Display, And Edit, 133

Parameters of Normal Direction Control, 297

Parameters of Online Custom Screen, 33

Parameters of Path Axis Reassignment, 417

Parameters of Pattern Data Input, 321

Parameters of Peck Drilling Cycle of a Small Diameter, 263

Parameters of Pitch Error Compensation, 178

Parameters of Polar Coordinate Interpolation, 294

Parameters of Polygon Turning, 390

Parameters of Position Switch Functions, 361

Parameters of Positioning by Optimum Acceleration, 322

Parameters of Power Motion Manager, 38

Parameters of Programs, 167

Parameters of reader/puncher interface, remote buffer, dnc1, dnc2, and m-net interface, 13

Parameters of Reference Position Setting with Mechanical Stopper, 375

Parameters of Rigid Tapping, 267

Parameters of Scaling/Coordinate Rotation, 291

Parameters of Servo, 96

Parameters of Setting , 9, 306

Parameters of Simple Synchronous Control, 435

Parameters of Skip Function, 326

Parameters of Software Operator's Panel, 377

Parameters of Spindle Control, 190

Parameters of Straightness Compensation, 309

Parameters of Stroke Check, 55

Parameters of the Chuck and Tailstock Barrier (T Series), 60

Parameters of the External Pulse Input, 395

Parameters of the Hobbing Machine and Simple Electric Gear Box, 396

Parameters of Tool Compensation, 239

Parameters of Tool Life Management, 355

Parameters of Two-path Control, 413

Parameters of Uni-directional Positioning, 293

[S]

Setting Parameters from MDI, 2

Revision Record

FANUC Series 16i/18i/160i/180i/160is/180is – MODEL A PARAMETER MANUAL (B-63010EN)

02	Feb., 2001	<p>Addition of parameters below :</p> <p>Setting, Reader/puncher interface, DNC1/DNC2 interface, FACTOLINK, Data server, Coordinates, Stroke check, Feedrate, Acceleration/deceleration control, Servo, DI/DO, MDI, display, and edit, Programs, Pitch error compensation, Spindle control, Tool compensation, canned cycles, Rigid tapping, Scaling/coordinate rotation, Uni-directional positioning, Involute interpolation, Straightness compensation, Custom macros, Positioning by optimum acceleration, Skip function, External data input/output, Graphic display, Tool life management, Position switch functions, manual operation and automatic operation, Manual handle feed, handle interruption and handle feed in tool axial direction, Program restart, High-speed machining, Polygon turning, Hobbing machine and EGB, Axis control by PMC, Path axis reassignment, Angular axis control, B-axis control, Simple synchronous control, Chopping, HSPCC by RISC, Others, and Maintenance</p> <p>Addition of Sections below :</p> <p>Remote diagnosis, Memory card interface, Flexible synchronization, Gradient compensation, Simple macros, Fine torque sensing, Retracing by the manual handle, Manual operation and automatic operation, Rotary table dynamic fixture offset, High-speed position switches, Built-in macro, and Operation history</p>				
01	Apr., 1997	_____				
Edition	Date	Contents	Edition	Date	Contents	Contents

- *No part of this manual may be reproduced in any form.*
- *All specifications and designs are subject to change without notice.*